

AH diagnostics

# AN EXTRAORDINARY ADVENTURE

HEALTH AND SAFETY



AH diagnostics A/S  
Gammel Viborgvej 11A, 8381 Tilst, Denmark  
order@ahdiagnostics.dk +45 8745 9010  
<https://www.ahdiagnostics.dk/>



# AN EXTRAORDINARY ADVENTURE



## HEALTH AND SAFETY

---

### - PERSONAL PROTECTION: PROTECTIVE EQUIPMENT

Disposable laboratory gloves	
SHIELD SCIENTIFIC	1112 to 1115
KIMTECH / KLEENGUARD	1116 to 1119
MAPA	1120 and 1121
MICROFLEX	1122
SHOWA	1123 and 1124
ANSELL	1126
SEMPERGUARD	1127
ULMA	1127 and 1128
ANSELL HEALTHCARE examination/surgical gloves	1129 and 1130
Various examination gloves	1131 and 1132
Latex / Vinyl Fingers	1132
Household/cleaning gloves	1133 and 1134
Chemical protective gloves	1135 to 1137
Knitted, silk, cotton, mittens gloves and undergloves	1138
Mechanical protection gloves	1139 to 1141
Thermal protection gloves hot/cold	1142 to 1145
Respiratory protection: masks, half masks	1146 to 1154
Eye protection: glasses, masks, shields	1155 to 1162
Hearing protection: earmuffs, earplugs	1162 to 1164

---

### - PERSONAL PROTECTION : PROTECTIVE CLOTHING

Mob caps, beard protector	1165
Sleeves	1165 and 1166
Clogs, shoes and overshoes	1166 to 1169
Coveralls, lab coats, aprons	1170 to 1185

---

### - PERSONAL PROTECTION : PHARMACY, FIRST AID

Dressings, cotton wool, compresses, swabs, eyewash, first aid kits, medicine cabinets	1186 to 1191
---	--------------

---

# AN EXTRAORDINARY ADVENTURE



## HEALTH AND SAFETY

---

### • IDENTIFICATION, PROTECTION, WASTE MANAGEMENT

#### samples

Sample bags, zip lock bags, Whirl-Pak bags 1192 to 1196

Transport of samples: bags, transport kits UN 1197 to 1199

#### disposal, waste management

Bags and sachets, sample transport 1200 to 1207

Chemical and radioactive absorbents 1208 and 1209

Safety bottles and funnels 1210 to 1212

Waste containers, DASRI waste boxes 1213 to 1215

Packaging : aluminium, stretch film, Parafilm, sealing tapes 1216 to 1218

Wiping 1219 to 1226

Dispensers, holders 1227 and 1228

#### Marking, labelling

Markers, pens, laboratory notebooks 1228 to 1232

Labels and printers 1232 to 1261

Bench protectors: paper, mats, radioactivity protectors 1262 to 1271

Sterilisation 1272 to 1275

---

### • CLEANING

Brushes 1276

Detergents and disinfectants for dishes and instruments 1276 to 1284

Soaking trays 1284

Decontaminants RNase, DNase, incubator and bath disinfectants 1285 to 1287

Deodorants 1287

Detergents and disinfectants for surfaces, equipment and floors 1288 to 1295

Airborne disinfectants 1296

#### Hand cleaners and care :

soaps, hydroalcoholic solutions, creams 1296 to 1302

---

### • FURNITURE

#### Safety cabinets

Corrosive and flammable products cabinets, safety cabinets 1304 to 1314

Trolleys 1316 and 1317

Storage shelves 1318

Stainless steel furniture 1319

Laboratory furniture and cabinets 1320 to 1324

Seats 1325 to 1331

---

## Hand protection - what solutions?

An ALL-IN-ONE glove is a need expressed by anyone working in a laboratory:  
"I need a glove that is comfortable, protects against all types of aggression and at low cost".

We believe that the use of several gloves is unavoidable in order to deal with the various risks and to guarantee the well-being and safety of users (while preserving laboratory budgets!) by relying on a simple technical point: the thicker and longer the glove, the better protected you are!

## »» Standards and Regulations - How to find your way around?

### Regulation, legislative framework

#### • Obligations of the employer:

The **89/656/EEC Directive** sets out the employer's obligations to protect his staff. Identification of risks and protective solutions to be implemented through the Single Document.

#### • Obligations of the manufacturer (CE label):

Depending on the activity and end use of the gloves, there are several options for manufacturers:

- **93/42/EEC Directive: Medical Devices (MD)** / intended for the protection of the patient. These gloves are usually called examination gloves. This is a self-certification by the manufacturer.
- **EU 2016/425 Regulation: Personal Protective Equipment (PPE)** Designed to protect personnel against chemical and biological risks. Since April 2018 this regulation replaces Directive 89/686/EEC.

There are 3 categories of PPE

- **PPE Category I - Minor Risk** - Simple CE marking, must be used for low risk handling. This is a self-certification by the manufacturer.
- **PPE Category II - Intermediate Risk**
- **PPE Category III - Risk of death or irreversible effects - Specific CE marking** Specific CE marking. Protection against chemical and biological risks. The manufacturer must be audited by a Notified Person (NP) identified by 4 digits:  
0120 = SGS; 0493 = CENTEXBEL; 0134 = SATRA

## »» Standards set a consensus for measuring product performance

The following standards are applicable to single-use gloves:

### Medical Device (MD) Standards

The **eN-455** standard allows the performance of examination gloves to be measured and compared between them:

- EN 455-1:2001:** Statistical leakage test - AQL 1.5 (Acceptable Quality Level)
- EN 455-2:2015:** Definition of physical characteristics such as length and height
  - The minimum length of an examination glove is 24 cm regardless of size
  - Sizes are expressed in letters from XS to XL
- EN 455-3:2015:** Biological assessment (measurement of protein levels in latex gloves)

### Personal Protective Equipment (PPE) Standards

The **EN 420:2003+A1:2009** standard defines the general requirements for protective gloves.

- The minimum length of a glove varies according to size, from 22cm (T6) to 27cm (T11)
  - Sizes are expressed in numbers from 6 to 11
  - If a glove is shorter than the standard, it must be explicitly stated on the packaging as "suitable for special applications"
- The **ISO 374 standard** defines a methodology for measuring protection against **chemical and biological hazards**.

## Choice of materials some general guidelines

	LATEX	NITRILE
<b>FORCES</b>	Elasticity Comfort Biological barrier Natural product Price	Biological Barrier Chemical Barrier Price stability Comfort (less hot)
<b>WEAKNESSES</b>	Allergies type I and IV Chemical Barrier Price instability Fragility	Allergies Type IV Elasticity Synthetic product Price

## ISO 374-5:2016: Biological risk assessment Determination of resistance to micro-organisms (AQL) and viral penetration

ISO 374-5: 2016 (replaces the former EN 374-2:2003)

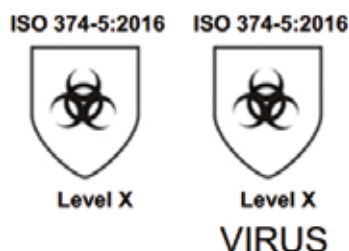

The **EN 374-2:2014 standard** remains to demonstrate the effectiveness of the bacteria and fungi resistance. Water or air tightness test (AQL level). There are three levels of performance:  
Level 1: AQL 4.0  
Level 2: AQL 1.5  
Level 3: AQL 0.65 (best guarantee of tightness).

The **ISO 16604:2004 procedure B** standard, determining the penetration resistance by blood-borne pathogens (Phi-X 174), is incorporated into the biohazard assessment; gloves meeting the standard are labelled "virus" under the biohazard pictogram.



## ISO 374-1:2016: Chemical risk assessment - terminology and performance requirements

ISO 16523-1:2015 and EN 374-4:2013

OLD STANDARD: EN 374-1:2003

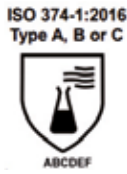

The "chemical resistant" pictogram refers to the identification letters of 3 chemicals (from a predefined list of 12 standard chemicals A to L) for which a minimum breakthrough time of 30 minutes (level 2) has been achieved.



**Permeation test:**  
EN 16523-1:2015

There are 18 chemicals tested (A to T); they are classified according to 3 types of performance levels:

- **TYPE A:** withstand more than 30 minutes (Level 2), 6/18 test chemicals
- **TYPE B:** withstand more than 30 minutes (Level 2), 3/18 test chemicals
- **TYPE C:** withstand more than 10 minutes (Level 1), 1/18 test chemicals

The chemical degradation test becomes mandatory (EN 374-4:2013): a needle stick resistance test is performed after prolonged exposure to the chemical substance. The result is expressed in % (the lower the %, the better the glove's resistance)

The pictogram "low chemical resistance" or "waterproof" should be used for gloves that have not demonstrated a breakthrough time of at least 30 minutes, for at least three of the predefined chemicals, but have passed the penetration test (EN 374-2 level 2).



Substances tested:

Identification letter	Chemical substance	CAS number	Type
A	Methanol	67-56-1	Primary alcohol
B	Acetone	67-64-1	Ketone
C	Acetonitrile	75-05-8	Nitrile compound
D	Dichloric methane	75-09-2	Chlorinated paraffin
E	Carbon sulphide	75-15-0	Sulphide containing an organic compound
F	Toluene	108-88-3	Aromatic hydrocarbon
G	Diethylamine	109-89-7	Heterocyclic etheric compound
H	Tetrahydrofuran	109-99-9	Heterocyclic etheric compound
I	Ethyl acetate	141-78-6	Ester
J	n-heptane	142-82-5	Saturated hydrocarbon
K	Caustic soda 40%	1310-73-2	Inorganic base
L	Sulphuric acid 96%	7664-93-9	Inorganic mineral acid
M	Nitric acid 5%	7697-37-2	Inorganic mineral acid, oxidising
N	Acetic acid 99%	64-19-7	Organic acid
O	Ammonium hydroxide 25%	1336-21-6	Organic base
P	Hydrogen peroxide 30%	7722-84-1	Peroxide
S	Hydrofluoric acid 40%	7664-39-3	Inorganic mineral acid
T	Formaldehyde 37%	50-00-0	Aldehyde

**Permeability:** each of the chemicals tested is ranked according to the breakthrough time (performance levels 0-6).

Observed transit time	Protection index	Observed transit time	Protection index
10 minutes	Class 1	120 minutes	Class 4
30 minutes	Class 2	240 minutes	Class 5
60 minutes	Class 3	480 minutes	Class 6

Multi-purpose gloves can also meet other standards, such as for mechanical and thermal protection.

### WHAT IS A MECHANICAL PROTECTION GLOVE?

The "mechanical risks" pictogram is accompanied by a 4-digit code, according to EN 388:2003. EN 388:2016 standard introduces two new factors (E and F) to measure the mechanical strength of gloves according to EN ISO 13997. In all cases, 0 indicates the lowest level of performance.



Tests	Performance levels					
	0	1	2	3	4	5
A. Abrasion resistance (cycles)	< 100	100	500	2000	8000	-
B. Blade cut resistance (factor)	< 1.2	1.2	2.5	5.0	10.0	20.0
C. Tearing resistance (Newton)	< 10	10	25	50	75	-
D. Puncture resistance (Newton)	< 20	20	60	100	150	-
	Performance levels					
	A	B	C	D	E	F
E. Cut resistance according to ISO standard (Newton)	2	5	10	15	22	30
F. Impact protection according to EN standard	Success (P) or failure (no marking)					

Level X: the test is not applicable or the glove has not been tested.

### WHAT IS A THERMAL-HOT PROTECTION GLOVE?

The standard EN 407: 2004 defines the requirements and test methods against thermal, heat and/or fire hazards. The pictogram is accompanied by 6 numbers illustrating the level of protection: index from 0 to 4.



Tests	Performance levels				
	0	1	2	3	4
A. Flammability / fire behaviour resistance: flame persistence time (s.), the time during which the material remains ignited and then continues to burn after the source of ignition has been removed		≤ 20 s	≤ 10 s	≤ 3 s	≤ 2 s
B. Contact heat resistance: temperature at which the wearer of the gloves will not feel any pain for a period of at least 15 s.		100 °C	250 °C	350 °C	500 °C
C. Convective heat resistance: heat transfer in seconds, time during which the glove is able to delay the heat transfer of a flame		≥ 4 s	≥ 7 s	≥ 10 s	≥ 18 s
D. Radiant heat resistance: heat transmission in seconds, the time during which the glove is able to delay heat transfer when exposed to a radiant source		≥ 5 s	≥ 30 s	≥ 90 s	≥ 150 s
E. Resistance to small splashes of molten metal: amount of molten metal required to achieve a temperature rise of 40 °C (number of drops)		≥ 5	≥ 15	≥ 25	≥ 35
F. Resistance to large splashes of molten metal: mass (g) of molten metal required to cause a superficial burn		≥ 30 g	≥ 60 g	≥ 120 g	≥ 200 g

Level X: the test is not applicable or the glove has not been tested.

### WHAT IS A THERMAL PROTECTION GLOVE - COLD ?

The EN 511 standard applies to all gloves that protect the hands against convective and contact cold down to -50 °C. The pictogram "risk by cold" is accompanied by a 3-digit number.



Tests	Performance levels				
	0	1	2	3	4
A. Convective cold resistance: cold transfer by convection (thermal insulation in m², °C/W)		≥ 0.10	≥ 0.15	≥ 0.22	≥ 0.30
B. Contact cold resistance: thermal resistance when in contact with a cold object (in m², °C/W)		≥ 0.025	≥ 0.050	≥ 0.100	≥ 0.150
C. Water permeability after 30 min. exposure	Water penetration	No water penetration	-	-	-

Level X: the test is not applicable or the glove has not been tested.

Only the use of several gloves will effectively protect you from the various risks encountered in the laboratory. SHIELD Scientific presents a simple, three-colour system to make your choice easier:



### HIGH CHEMICAL RISKS

Double-layered, bi-material gloves, meeting chemical risk standards: protection without ignoring comfort.



### HIGH BIOLOGICAL RISKS

Gloves that meet biohazard standards. Maximum safety for both the user and his handling.



### RISKS IN EVERYDAY LIFE

Latex or nitrile gloves, the thickest of the thin gloves on the market. Designed for everyday use, they meet the latest PPE standards. A special effort to respect the environment has been made in the manufacture and packaging of EcoSHIELD gloves.

## SHIELDskin CHEM™ and SHIELDskin™ Gloves

- PPE Category III according to Regulation EU/2016/425
- DM class I according to Directive 93/42/EEC
- Complies with the EN 420:2003 standard, which defines, among other things, the size of the gloves and the minimum lengths for good protection of the wearer
- Powder-free, chlorination and multiple washings
- Ambidextrous

- Assessed for biological risk according to ISO 374-5:2016 and EN 374-2:2014
- Virus resistant: ISO 16604:2004 procedure B
- Assessed for chemical risk according to ISO 374-1:2016, EN 16523-1:2015 and EN 374-4:2013
- Extensive chemical resistance database available at [www.shieldscientific.fr](http://www.shieldscientific.fr)

### SHIELDskin CHEM™ NEO NITRILE™ Gloves 300 mm

The 1<sup>st</sup> glove for chemical protection!



- Bi-materials: nitrile/neoprene bilayer (white inside, red outside), TwinSHIELD™ double dip technology
- Length 300 mm; palm thickness: 0.31 mm
- Biohazard: AQL 0.25 above standard - level 3
- Chemical risk: Type A (AJKLNPT)

XS/6	S/7	M/8	L/9	XL/10	XXL/11	Units/box	Price/box
065809	065810	065811	065812	065813	065814	40	N/A -

### SHIELDskin™ ORANGE NITRILE™ Gloves 260, 300 mm and 300 mm sterile



\* except SHIELDskin Orange Nitrile Sterile

- Bi-materials: nitrile/neoprene bilayer (white interior, orange exterior), TwinSHIELD™ double dip technology
- No vulcanisation accelerator to limit allergic phenomena
- Length 260 or 300 mm; palm thickness: 0.14 mm
- RNase/DNase free certified sterile version
- Biohazard: AQL 0.25 above standard - level 3
- Chemical hazard: type B (JKPT)
- Resistance to cytotoxics
- ESD: anti-electrostatic properties (EN 1149-1 to 5)

#### SHIELDskin™ ORANGE NITRILE™ Gloves 260 mm

Size	XS/6	S/7	M/8	L/9	XL/10	Units/box	Price/box
Cat. No.	065700	065701	065702	065703	065704	90	N/A -

#### SHIELDskin™ ORANGE NITRILE™ Gloves 300 mm

Size	XS/6	S/7	M/8	L/9	XL/10	Units/box	Price/box
Cat. No.	065705	065706	065707	065708	065709	50	N/A -

#### SHIELDskin™ ORANGE NITRILE™ Gloves, sterile, 300 mm - RNase and DNase free

Size	XS/6	S/7	M/8	L/9	XL/10	Pairs/box	Price/box
Cat. No.	065748	065749	065750	065751	065752	20	N/A -



The ecoSHIELD™ gloves have been designed to meet the daily requirements of laboratories: protection, comfort and economy. ecoSHIELD™ is an optimised solution for both users and our environment.

### Eco-PACKAGING

- Packaging made from recycled cardboard only
- The ink used is free of all heavy metals
- Reduction of more than 60% of printing on packaging



### Eco-LOGISTICS

- Reduction of storage space: by 50
- Air transport, 10 times more polluting than land transport, is not used for the delivery of ecoSHIELD™ gloves
- Less packaging per quantity of gloves
- Optimised production
- Lean logistics

## EcoSHIELD™ Gloves PF 250

- PPE category III according to the EU/2016/425 regulation
- Complies with the EN 420:2003 standard, which defines, among other things, the size of the gloves and the minimum lengths for good protection of the wearer
- Powder-free, simple chlorination and washing
- Assessed for biological risk: assessed according to ISO 374-5:2016 and EN 374-2:2014
- Virus resistant: ISO 16604:2004 procedure B
- Assessed for chemical risk according to ISO 374-1:2016, EN 16523-1:2015 and EN 374-4:2013

### EcoSHIELD™ Eco Nitrile PF 250 Gloves



- Dual-layer nitrile (white inside, green outside)
- Ambidextrous: TwinSHIELD™ technology
- Length 250 mm (size XL/10 = 260 mm); palm thickness: 0.10 mm
- Biohazard: AQL 0.25 (above standard) - level 3
- Chemical risk: Type B (KPT)

Size	XS/6	S/7	M/8	L/9	XL/10	Units/box	Price/box
Cat. No.	065744B	065745B	065746B	065747B	065825B	150	N/A -

### EcoSHIELD™ Eco Latex PF 250 Gloves



- 100% latex - natural; latex allergy: protein level < 30 µg/ G (EN 455-3:2015)
- Length 250 mm (size XL/10 not available); palm thickness: 0.12 mm
- Biohazard: AQL 0.65 - level 3
- Chemical risk: TYPE B (KPT)

Size	XS/6	S/7	M/8	L/9	Units/box	Price/box
Cat. No.	065789	065790	065791	065792	100	N/A -



**DOUBLE RISK  
MINOR RISKS**

duoSHIELD™ gloves offer a good compromise and cost designed to meet the minimal risk needs of laboratory technicians. They are to be reserved for dirty work, which does not present any particular danger or simply to protect the patient (the primary purpose of a medical device). "DUO" refers to the registration of these gloves as medical devices (MD) and personal protective equipment (PPE).

## Dual-registered gloves

- > Class I Medical Devices according to Directive 93/42/EEC and PPE Category III according to Regulation EU/2016/425 (Directive 89/686/EEC for PFT Nitrile 240 mm)
- > Length according to EN 455-2: 2015\*
- > Assessed for biological risk (AQL) according to EN455-1:2000, ISO 374-5:2016 and EN 374-2:2014
- > Assessed for chemical risk according to ISO 374-1:2016, EN 16523-1:2016 and EN 374-4:2014

### duoSHIELD™ ICE NITRILE™ Gloves 240 mm



- > 100% SuperSoft Nitrile - blue
- > Powder-free, simple chlorination and washing
- > Length 240 mm\*, palm thickness: 0.11 mm
- > Biohazard: AQL 1.5 - level 2
- > Chemical risk: Type B (KPT)

Size	XS/6	S/7	M/8	L/9	XL/10	Units/box	Price/box
Cat. No.	065735	065736	065737	065738	065739	100	N/A -

### duoSHIELD™ PFT latex Gloves 240 mm



- > 100% latex - natural
- > Textured finish
- > Powder-free, simple chlorination and washing
- > Length 240 mm\*, palm thickness: 0.11 mm
- > Latex allergy: protein level below 30 µg/g (455-3:2015)
- > Biohazard: AQL 1.5 - level 2
- > Chemical risk: Type B (KPT)

Size	XS/6	S/7	M/8	L/9	XL/10	Units/box	Price/box
Cat. No.	065730	065731	065732	065733	065734	100	N/A -

### duoSHIELD™ LPS Latex Gloves 240 mm



- > 100% latex - natural
- > Latex allergy: protein level below 200 µg/g (455-3:2015)
- > Lightly powdered, smooth finish
- > Length 240 mm\*, palm thickness: 0.11 mm
- > Biohazard: AQL 1.5 - level 2
- > Chemical risk: Type B (KPT)

Size	XS/6	S/7	M/8	L/9	XL/10	Units/box	Price/box
Cat. No.	065720	065721	065722	065723	065724	100	N/A -

### duoSHIELD™ PFT Nitrile Gloves 240 mm



- > DM class I (93/42/EEC) / EPI Cat. III (Directive 89/686/EEC)
- > Powder-free nitrile, latex-free, white
- > Rolled edge cuffs, textured ends
- > Palm thickness: 0.06 mm, length 240 mm\*
- > Biohazard: AQL 0.65 - level 3
- > Virus resistant: according to ISO 374-5:2016 and ISO 16604:2004 procedure B
- > Chemical risk: Type C (KT)
- > Certified for food contact

Size	XS/6	S/7	M/8	L/9	XL/10	Units/box	Price/box
Cat. No.	065906	065907B	065908	065909	065910B	200	N/A -

\* In accordance with EN 455-2:2015. PPE: suitable for special applications. Sizes L/9 and XL/10 have a shorter length (240 mm) than the minimum length required by EN 420:2003 (250 mm and 260 mm) for PPE.





## SHIELDskin XTREME™

PROCESS RISKS  
PRODUCT PROTECTION

SHIELDskin XTREME™ is a range designed for use in controlled atmosphere areas (cleanrooms). It is organised into 3 product categories, depending on the degree of cleanliness: from "DI" for the least clean to "DI++" for the most demanding. In addition to protecting the product/process, all these gloves meet the latest PPE category III standards to protect the operator. Finally, the range offers a wide variety of materials, lengths, sterile and non-sterile. Please contact us for any other glove in the range not shown in the catalogue.

### SHIELDskin XTREME™ Gloves

- PPE category III according to the EU/2016/425 regulation
- Complies with the EN 420:2003 standard, which defines, among other things, the size of the gloves and the minimum lengths for good protection of the wearer
- Powder-free, chlorination, multiple washings
- Assessed for biological risk: according to ISO 374-5:2016 and EN 374-2:2014
- Assessed for chemical risk according to ISO 374-1:2016, EN 16523-1:2015 and EN 374-4:2013

The number of de-ionised water washes is the major differentiator in terms of ultra-cleanliness:

Range	Procedure	Benefits
SHIELDskin XTREME™ DI	Single wash with de-ionised water	- Most economical option / - Typical particle level $\geq 0.5 \mu\text{m}$ : $\lt 3000$ per $\text{cm}^2$
SHIELDskin XTREME™ DI+	Triple wash with de-ionised water	- Typical level of particles $\geq 0.5 \mu\text{m}$ : $\lt 950$ per $\text{cm}^2$
SHIELDskin XTREME™ DI++	Multiple washings with de-ionised water	- Typical level of particles $\geq 0.5 \mu\text{m}$ : $\lt 650$ per $\text{cm}^2$

#### SHIELDskin XTREME™ Sterile Latex 300 DI Gloves

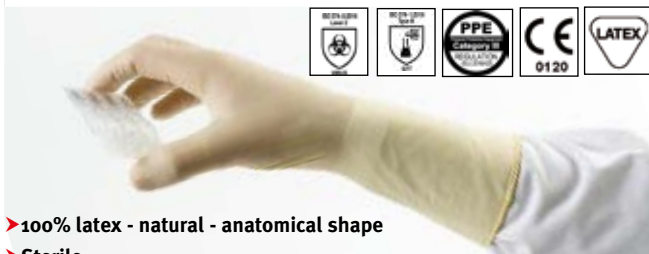

- 100% latex - natural - anatomical shape
- Sterile
- Length 300 mm, palm thickness: 0.14 mm
- Latex allergy: protein level below 50µg/ g (EN 455-3:2006)
- Biohazard: AQL 1.5 - Level 2
- Virus resistant: ISO 374-5:2016 and ISO 16604:2004 procedure B
- Chemical risk: Type B (KPT)
- Packed per pair, 20 pairs/PE bag

Size	XS/6	S/7	M/8	L/9	XL/10	Pairs/ bag	Price/ bag
Cat. No.	065783	065784	065785	065786	065787	20	N/A -

#### SHIELDskin XTREME™ Bright Latex 300 DI+ Gloves



- 100% latex - natural - anatomical shape
- Latex allergy: protein level below 50µg/ g (EN 455-3:2006)
- Length 300 mm, palm thickness: 0.14 mm
- Biohazard: AQL 1.5 - Level 2
- Virus resistant: ISO 374-5:2016 and ISO 16604:2004 procedure B
- Chemical hazard: type B (KPT)
- Packaging: 100 gloves / double PE bag

Size	XS/6	S/7	M/8	L/9	XL/10	XXL/11	Units/ bag	Price/ bag
Cat. No.	065777	065778	065779	065780	065781	065782	100	N/A -

#### SHIELDskin XTREME™ ECO NITRILE 300 DI+ Gloves

- 100% nitrile - white
- Length: 300 mm; palm thickness: 0.10 mm
- Biohazard: AQL 1.5 - level 2
- Anti-electrostatic properties: ESD test according to EN 1149-1-2-3 & 5
- Chemical hazard: type B (KPT)
- Packaging: 100 gloves / double PE bag

Size	XS/6	S/7	M/8	L/9	XL/10	XXL/11	Units/ bag	Price/ bag
Cat. No.	065874B	065875B	065876B	065877B	065878B	065879B	100	N/A -



#### SHIELDskin XTREME™ White NITRILE 300 Gloves

- 100% nitrile - white
- Length 300 mm
- Anti-electrostatic properties: ESD test according to EN 1149-1-2-3 & 5
- Biohazard: AQL 1.5 - Level 2
- Chemical hazard: type B (KPT)
- Packaging: 100 gloves / double PE bag

##### ➤ SHIELDskin XTREME White NITRILE 300 DI GLOVES

- Palm thickness (mm): 0.13

##### ➤ SHIELDskin Xtreme NITRILE 300 DI++ GLOVES

- Palm thickness (mm): 0.14

Size	XS/6	S/7	M/8	L/9	XL/10	XXL/11	Units/ bag	Price/ bag
SHIELDskin XTREME™ White Nitrile 300 DI Gloves								
Cat. No.	065753	065754	065755	065756	065757	065758	100	N/A -
SHIELDskin XTREME™ White Nitrile 300 DI++ Gloves								
Cat. No.	065765	065766	065767	065768	065769	065770	100	N/A -



SHIELDskin XTREME™  
White Nitrile 300 Gloves

## KIMTECH™ Prizm and Prizm Xtra Gloves



Made of multi-layer nitrile-neoprene for enhanced chemical protection. For high-risk laboratory applications: biotechnology, pharmaceutical industry, research. Ultra-grippy end: non-slip in wet or dry conditions.

- ▶ PPE Cat. III according to Regulation EU 2016/425
- ▶ Chemical protection: type A (JKLMPT) according to ISO 374-1:2016
- ▶ Protection against viruses and micro-organisms according to ISO 374-5:2016
- ▶ AQL 0.65
- ▶ Resistance to many cytotoxic drugs
- ▶ Thickness (palm): 0.16 mm
- ▶ Dark purple and magenta: mechanical fracture indicator

## Prizm gloves: 240 mm cuff

Size	XS	S	M	L	XL	Units/box	Price/box
Cat. No.	002316	002317	002318	002319	002320*	100	N/A -

\* Size XL: 90 gloves/box

## Prizm XTRA gloves: 300 mm long cuff

Size	XS	S	M	L	XL	Units/box	Price/box
Cat. No.	002311	002312	002313	002314	002315	50	N/A -

## KIMTECH™ PURPLE NITRILE™ and PURPLE NITRILE™ XTRA™ Gloves



- ▶ 100% nitrile, latex-free, eliminates all Type I allergy risks
- ▶ Undetectable chemical agents: significantly reduces the risk of Type IV allergies
- ▶ Excellent chemical and mechanical resistance, resistance to cytotoxic products and B.E.T.
- ▶ Certified PPE Cat. III according to Regulation (EU) 2016/425
- ▶ Certified to EN ISO 374-1:2016 Type B (JKT), limited protection against chemical splashes
- ▶ ISO 374-5:2016 Protection against micro-organisms and viruses
- ▶ AQL: 0.65
- ▶ Purple
- ▶ Powder-free, smooth finish, textured fingertips
- ▶ Antistatics
- ▶ Rolled edge cuff
- ▶ Thickness: 0.14 mm in the palm

## Kimtech™ Purple Nitrile™ Gloves

- ▶ Standard length 240 mm (250 mm for sizes L and XL)

Size	XS	S	M	L	XL	Units/box	Price/box
Cat. No.	038820	038821	038822	038823	038824*	100	N/A -

\* box of 90

## Kimtech™ Purple Nitrile™ Xtra™ Gloves: special for culture, long sleeves

- ▶ Length 300 mm

Size	XS	S	M	L	XL	Units/box	Price/box
Cat. No.	038825	038826	038827	038828	038829	50	N/A -

## KIMTECH™ STERLING™ NITRILE and STERLING™ NITRILE XTRA™ Gloves



Practical: box of 150 gloves for the 240 mm length or 100 gloves for the 300 mm length! Space saving of 33% and waste reduction of 40%.

- ▶ 100% nitrile free of latex proteins: eliminates any potential risk of Type I allergy
- ▶ Great dexterity, great comfort
- ▶ Certified PPE Cat. III according to Regulation (EU) 2016/425
- ▶ ISO 374-1:2016 Type C (K) against chemical splashes
- ▶ ISO 374-5:2016 Protection against micro-organisms and viruses
- ▶ AQL: 0.65
- ▶ Colour: light grey
- ▶ Powder-free, smooth finish, textured fingertips
- ▶ Antistatics
- ▶ Rolled edge cuff
- ▶ Thickness: 0.08 mm in the palm

## Gants KIMTECH™ Sterling™ Nitrile Xtra™ (long cuff)

- ▶ Length: 300 mm

Size	XS	S	Units/box	Price/box
Cat. No.	040437	040438	100	N/A -

## KIMTECH™ Sterling™ Nitrile Gloves

- ▶ Standard length: 240 mm (250 mm for size XL)

Size	XS	S	M	L	XL	Units/box	Price/box
Cat. No.	040132	040133	040134	040135	040136*	150	N/A -

\* box of 140



**KIMTECH™ GREEN NITRILE Gloves**

Significantly reduces space and waste by 60%: 250 gloves per box.

- Latex-free acrylonitrile butadiene: reduces the potential risk of Type I allergy
- PPE Cat. III according to Regulation (EU 2016/425)
- ISO 374-5:2016 Protection against micro-organisms and viruses
- ISO 374-1:2016 Type C (K) against chemical splashes
- AQL: 0.65
- Colour: green
- Powder-free, smooth finish, textured fingertips
- Rolled edge cuff
- Thickness: 0.06 mm in the palm
- Length: 240 mm (250 mm for sizes L and XL)



Size	XS	S	M	L	XL	Units/box	Price/box
Cat. No.	040392	040393	040394	040395	040396*	250	N/A -

\* box of 225

**KIMTECH™ BLUE NITRILE Gloves**

Latex-free acrylonitrile butadiene: reduces the potential risk of type I allergy.

- PPE Cat. III according to Regulation (EU 2016/425)
- ISO 374-5:2016 Protection against micro-organisms and viruses
- AQL: 1.5
- Colour: blue
- Powder-free, smooth finish
- Rolled edge cuff
- Thickness: 0.12 mm in the palm
- Length: 240 mm (250 mm for sizes L and XL)



Size	S	M	L	XL	Units/box	Price/box
Cat.No.	038849	038850	038851	038868*	100	N/A -

\* box of 90

**KIMTECH™ Natural Latex Gloves**

- PPE Cat. III according to Regulation (EU 2016/425)
- Natural latex, protein < 50 µg/g
- Rolled edge cuff
- ISO 374-5:2016 Protection against micro-organisms and viruses
- ISO 374-1:2016 Type C (K) against chemical splashes
- AQL: 1.5

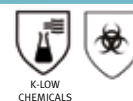

**KIMTECH™ PFE Latex Gloves**

- Length: 240 mm (250 mm for sizes L and XL)
- Thickness: 0.15 mm in the palm
- Powder-free, fully textured finish for excellent wet and dry grip



Size	XS	S	M	L	XL	Units/box	Price/box
Cat. No.	038847	038806	038807	038808	038809*	100	N/A -

\* box of 90

**KIMTECH™ PFE-Xtra Latex Gloves: long cuffs**

- Length: 300 mm
- Thickness: 0.15 mm in the palm
- Powder-free, fully textured finish for excellent wet and dry grip



Size	S	M	L	XL	Units/box	Price/box
Cat.No.	038816	038817	038818	038819	50	N/A -

**KIMTECH™ Satin Plus Latex Gloves**

- Length: 240 mm (250 mm for sizes L and XL)
- Thickness: 0.15 mm in the palm
- Powder-free, smooth finish



Size	XS	S	M	XL	Units/box	Price/box
Cat. No.	038810	038811	038812	038814*	100	N/A -

\* box of 90



See glove box holders page 1228

Product protection - controlled environments

KIMTECH™ G3 and G5 latex Gloves



G3 gloves recommended for ISO 3 or higher cleanroom environments.  
G5 gloves recommended for ISO 5 or higher cleanroom environments.

- Silicone-free latex gloves, low in endotoxins and proteins to reduce the risk of allergy
- Certified PPE Cat. III according to Regulation (EU) 2016/425
- ISO 374-1:2016 Type C (K) against chemical splashes
- ISO 374-5:2016 Protection against micro-organisms and viruses
- Powder-free natural latex, protein < 50 µg/g
- AQL: 1.5
- Rolled edge cuff
- Length: 300 mm
- Textured fingertips

KIMTECH™ G3 Latex Gloves

- Thickness: 0.20 mm in the palm
- Packaging: 100 gloves in double plastic bag

Size	S	M	L	XL	Units/bag	Price/bag
Cat.No.	038830	038831	038832	038833	100	N/A -

KIMTECH™ G5 Latex Gloves

- Thickness: 0.18 mm in the palm
- Packaging: 100 gloves in double plastic bag

Size	S	M	L	XL	Units/bag	Price/bag
Cat.No.	038853	038854	038855	038910	100	N/A -

KIMTECH™ G3 sterile Latex Gloves

- Thickness: 0.20 mm in the palm
- Packaged per pair, 20 pairs per double plastic bag

Size	6	6 1/2	7	7 1/2	8	8 1/2	9	10	Price/the
Cat. No.	038834B	038835B	038836B	038837B	038838B	038839B	038840B	038841B	N/A -

KIMTECH™ G3 NXT™ Nitrile Gloves



Recommended for ISO 3 or higher cleanroom environments.

- Latex and silicone free nitrile gloves to reduce the risk of type I allergies
- Certified PPE Cat. III according to Regulation (EU) 2016/425
- ISO 374-1:2016 Type C (K) against chemical splashes
- ISO 374-5:2016 Protection against micro-organisms and viruses
- AQL: 1.5
- Rolled edge cuff
- Length: 300 mm
- Thickness: 0.13 mm in the palm
- Textured fingertips
- Electrostatic dissipative properties

KIMTECH™ G3 NXT™ Nitrile Gloves

- Packaging: 100 gloves in double plastic bag

Size	XS	S	XL	Units/bag	Price/bag
Cat. No.	038911	038912	038915	100	N/A -

Blue Nitrile KleenGuard® G10 Gloves



- Powder-free: reduces the drying effects of powder on the skin
- CE marking: cat 1
- Latex-free: reduces the potential risk of Type I allergic reactions
- Textured tips for exceptional tactile sensitivity

Size	S	M	L	XL	Units/box	Price/box
Cat. No.	038971	038972	038973	038974*	100	N/A -

\* The price of the XL size glove boxes is for a package of 90 gloves (instead of 100).



KleenGuard® Arctic Blue Nitrile G10 Gloves

- External accreditation: Food Contact accredited
- EN 420: Food contact certification according to BFR regulation XXI
- 0.06 mm thick
- Blue
- General use
- Latex-free
- Powder-free
- Textured fingertips
- Rolled edge cuffs
- Ambidextrous
- PPE cat. I marking



Size	XS	S	M	L	XL	Units/ box	Price/ box
Car. No.	040368	040369	040370	040371	040372*	200	N/A -

\* sold per 180

## MAPA Food Expert Gloves



➤ Gloves suitable for food contact according to the European directive EEC 1935/2004

Model	Material	Interior finish	Exterior finish	Length/Thickness	Standards	Description / Applications	Size	Cat. No.	Packaging unit	Price
<b>SOLO 997</b>  Cat. 3	Nitrile	Chlorinated	Smooth with granulated fingertips	245 mm / 0.10 mm	 JKT	➔ <b>Description</b> <ul style="list-style-type: none"> <li>Excellent dexterity thanks to the flexibility and thinness of nitrile</li> <li>Multi-purpose: can be used alone or as an over-glove</li> </ul> ➔ <b>Applications</b> <ul style="list-style-type: none"> <li>Suitable for contact with all kinds of food</li> <li>Recommended for handling fatty foods and in oily industrial environments</li> </ul>	6	<b>430095</b>	1 box of 100 gloves	N/A -
							7	<b>430096</b>		N/A -
							8	<b>430097</b>		N/A -
							9	<b>430098</b>		N/A -
<b>SUPER FOOD 177</b>  Cat. 3	Latex natural	Chlorinated	Anti-slip surface	310 mm / 0.40 mm	 0010	➔ <b>Description</b> <ul style="list-style-type: none"> <li>Dexterity and flexibility</li> <li>Chlorinated finish for better protection of the products handled</li> </ul> ➔ <b>Applications</b> <ul style="list-style-type: none"> <li>Suitable for handling foodstuffs</li> </ul>	6	<b>430090</b>	1 box of 10 pairs	N/A -
							7	<b>430091</b>		N/A -
							8	<b>430092</b>		N/A -
							9	<b>430093</b>		N/A -
							10	<b>430094</b>		N/A -
<b>SUPER FOOD 165</b>  Cat. 1	Latex natural	Flocking	Anti-slip surface	305 mm / 0.29 mm		➔ <b>Description</b> <ul style="list-style-type: none"> <li>Flexibility of natural latex: excellent dexterity</li> <li>Very comfortable cotton flock</li> </ul> ➔ <b>Applications</b> <ul style="list-style-type: none"> <li>Suitable for certain uses in the food industry and in contact with food (see mini-guide)</li> </ul>	7	<b>430086</b>	1 box of 10 pairs	N/A -
							8	<b>430087</b>		N/A -
							9	<b>430088</b>		N/A -
							10	<b>430089</b>		N/A -

## MAPA Protective gloves for critical environments

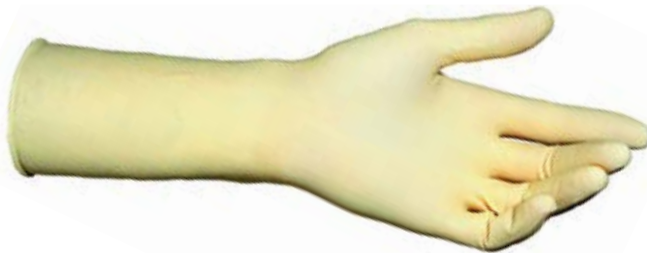

➤ Protect yourself and the objects and products you handle  
 ➤ The "critical" range has been developed to meet all the quality criteria necessary for work in controlled and confined environments (cleanrooms, glove boxes)

Model	Material	Interior / ext finish	Length/Thickness	Standards	Description / Applications	Size	Trionic 517 12 pairs		Trionic 517 1 pair		Trionic 522 1 pair length 610 mm	
							Cat. No.	Price	Cat. No.	Price	Cat. No.	Price
<b>TRIONIC 517 and 522</b>  Cat. 3	Tri-polymer: natural latex, neoprene and nitrile	Chlorinated/ Pebbled embossing	360 mm (Trionic 517) or 610 mm (Trionic 522) / 0.50 mm	 1110	➔ <b>Description</b> <ul style="list-style-type: none"> <li>Excellent chemical resistance</li> <li>Low level of contaminants ensured in manufacturing: particle content, non-volatile residues, extractables (ISO class 5 compatibility, class M3.5)</li> </ul> • Wrist: straight cuff ➔ <b>Applications</b> <ul style="list-style-type: none"> <li>Suitable for gentle handling of both chemicals and electronic components</li> </ul>	6	<b>430102</b>	N/A -	<b>430102B</b>	N/A -	-	-
						7	<b>430103</b>	N/A -	<b>430103B</b>	N/A -	-	-
						8	<b>430104</b>	N/A -	<b>430104B</b>	N/A -	<b>430108</b>	N/A -
						9	<b>430105</b>	N/A -	<b>430105B</b>	N/A -	<b>430109</b>	N/A -
						10	<b>430106</b>	N/A -	<b>430106B</b>	N/A -	<b>430110</b>	N/A -

MAPA single-use gloves

► Single-use gloves for various simple hand protection needs







Solo 999



Solo 998



Trilites 994

Model	Material	Interior finish	Exterior finish	Length/Thickness	Standards	Description / Applications	Size	Cat. No.	Packaging unit	Price
Solo 998	Latex	Chlorinated	Smooth, with granulated fingertips	300 mm/ 0.10 mm	Cat. 3  Type C	→ <b>Description</b> <ul style="list-style-type: none"> <li>• Suitable for short-term use</li> <li>• Easy to put on and to take off</li> <li>• Very fine latex: flexibility and dexterity</li> <li>• Rolled edge cuff: more resistant when putting on</li> </ul>	6	430077B	Box of 100 gloves	N/A -
							7	430078B		N/A -
							8	430079B		N/A -
							9	430080B		N/A -
Solo 992	Latex	Powder	Smooth	245 mm/ 0.10 mm	 Type C	→ <b>Applications</b> <ul style="list-style-type: none"> <li>• Suitable for routine use in laboratories, hospitals and clinics</li> </ul>	6	430111	Box of 100 gloves	N/A -
							7	430112		N/A -
							8	430113		N/A -
9	430114	N/A -								
Solo 999	Nitrile	Chlorinated	Smooth, with granulated fingertips	300 mm/ 0.10 mm	Cat. 3  Type B JKT	→ <b>Description</b> <ul style="list-style-type: none"> <li>• Excellent mechanical resistance</li> <li>• Easy to put on and to take off</li> <li>• Very thin glove for a precise gesture</li> <li>• For people sensitive to latex proteins</li> </ul>	6	430081B	Box of 100 gloves	N/A -
							7	430082B		N/A -
							8	430083B		N/A -
							9	430084B		N/A -
Solo White 997	Nitrile	Chlorinated	Smooth, with granulated fingertips	245 mm/ 0.10 mm	 Type B JKT	→ <b>Applications</b> <ul style="list-style-type: none"> <li>• Ideal for oily environments</li> <li>• Suitable for routine laboratory use</li> </ul>	6	430073B	Box of 100 gloves	N/A -
							7	430074B		N/A -
							8	430075B		N/A -
9	430076B	N/A -								
Trilites 994	Tri-polymer formula: Natural latex, neoprene and nitrile	Chlorinated	Granita	255 mm/ 0.15 mm	Cat. 3  Type B KPT	→ <b>Description</b> <ul style="list-style-type: none"> <li>• Unique three-polymer blend: increased comfort and strength</li> <li>• Protection against chemical splashes</li> <li>• Rolled edge cuff: more resistant when putting on</li> </ul>	6	430069B	Box of 100 gloves	N/A -
							7	430070B		N/A -
							8	430071B		N/A -
							9	430072B		N/A -
						→ <b>Applications</b> <ul style="list-style-type: none"> <li>• Particularly suitable for use in pharmaceutical laboratories</li> </ul>				



Latex-free gloves 73-847 ex Neopro Green



- ▶ Dark green neoprene, latex-free
- ▶ Ambidextrous, powder-free
- ▶ Rolled edge cuffs
- ▶ Textured ends
- ▶ Thickness: 0.10 mm
- ▶ Length: 245 mm
- ▶ AQL: 1.5
- ▶ PPE Cat. III
- ▶ Antistatics according to EN 1149

Size	XS	S	M	L	XL	Units/box	Price/box
Cat. No.	678231	678232	678233	678234	678235	100	N/A -

Powder-free latex gloves 63-864 ex Diamond Grip

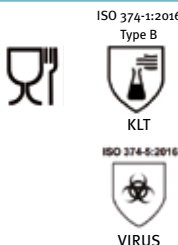

- ▶ In thick natural latex, natural colour
- ▶ Ambidextrous, powder-free
- ▶ Rolled edge cuffs
- ▶ Textured ends
- ▶ Thickness: 0.16 mm
- ▶ Length: 245 mm
- ▶ AQL: 1.5
- ▶ PPE Cat. III
- ▶ Certified for food contact

Size	XS	S	M	L	XL	Units/box	Price/box
Cat. No.	050405B	050406B	050407B	050408B	050409B	100	N/A -

Powder-free nitrile gloves 93-843 ex Supreno

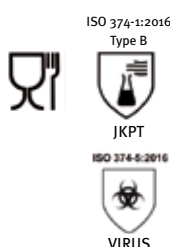

- ▶ Highly durable blue-violet nitrile, latex-free
- ▶ Ambidextrous, powder-free
- ▶ Rolled edge cuffs
- ▶ Textured ends
- ▶ Thickness: 0.11 mm
- ▶ Length: 245 mm
- ▶ AQL: 0.65
- ▶ PPE Cat. III
- ▶ Certified for food contact

Size	XS	S	M	L	XL	Units/box	Price/box
Cat. No.	050415B	050416B	050417B	050418B	050419B	100	N/A -

Powder-free nitrile gloves with long cuff 93-853 ex Supreno EC-Plus



- ▶ Made of blue-violet high-strength nitrile, latex-free
- ▶ Ambidextrous, powder-free
- ▶ Rolled edge cuffs
- ▶ Textured ends
- ▶ Thickness: 0.14 mm
- ▶ Long cuffs: 295 mm
- ▶ AQL: 0.65
- ▶ PPE Cat. III
- ▶ Antistatics

Size	XS	S	M	L	XL	Units/box	Price/box
Cat. No.	050450B	050451B	050452B	050453B	050454B	50	N/A -

Nitrile gloves PF 93-852 ex Midnight black



- ▶ Black nitrile for high contrast
- ▶ Ambidextrous, powder-free
- ▶ Rolled edge cuffs
- ▶ Textured ends
- ▶ Thickness: 0.12 mm
- ▶ Length: 245 mm
- ▶ PPE Cat. III
- ▶ Certified for food contact
- ▶ Antistatics according to EN 1149

Size	XS	S	M	L	XL	Units/box	Price/box
Cat. No.	050479B	050480B	050481B	050482B	050483B	100	N/A -

Nitrile examination gloves 93-833 ex XCEED

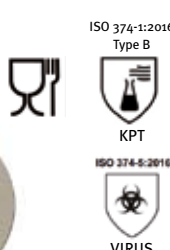

- ▶ Blue nitrile
- ▶ Ambidextrous, powder-free, certified ergonomic
- ▶ Rolled edge cuffs
- ▶ Textured ends
- ▶ Thickness: 0.07 mm
- ▶ Length: 240 mm
- ▶ AQL: 0.65
- ▶ PPE Cat. III
- ▶ Certified for food contact

Size	XS	S	M	L	XL	Units/box	Price/box
Cat. No.	050470B	050471B	050472B	050473B	050474B*	250	N/A -

\* units/box for Cat. No. 050474B: 230

## SHOWA Nitrile Gloves

100% nitrile, silicone-free, powder-free to prevent type I and IV allergies.

- PPE Cat. III
- Complies with medical device standards EN 455-1, -2, -3, -4
- Chlorinated gloves for more comfort and less stickiness
- Textured finish
- Low deformation factor for better ergonomics
- Resistant to cytostatics

### Cobalt blue range

➤ AQL: 0.65

	Length/ Thickness (mm)	XS (5 - 6)	S (6 - 7)	M (7 - 8)	L (8 - 9)	XL (9 - 10)	Gloves/ box	Price/ box
7540 series	240 / 0.10	924069	-	924071	-	-	100	N/A -
7580* series	240 / 0.20	-	924097	924098	924099	924100	50	N/A -
7545 series	300 / 0.10	-	924074	924075	924076	924077	100	N/A -
7555 series	300 / 0.12	924083	924084	924085	924086	924087	50	N/A -
7585* series	300 / 0.20	-	924101	924102	924103	924104	50	N/A -

\* double chlorination; EN 374-3: JKL

### Black antistatic range

➤ AQL: 1.5

➤ Surface resistivity: between  $10^9$  and  $10^{10}$   $\Omega$

	Length/ Thickness (mm)	S (6 - 7)	M (7 - 8)	L (8 - 9)	XL (9 - 10)	Gloves/ box	Price/ box
7565 series	300 / 0.15	924088	924089	924090	924091	50	N/A -

### High visibility range

➤ AQL: 1.5

- Without accelerator: protection for very sensitive skin
- High visibility by fluorescence (fluorescent green gloves): increased safety in poor lighting conditions

	Length/ Thickness (mm)	XS (5 - 6)	S (6 - 7)	M (7 - 8)	L (8 - 9)	XL (9 - 10)	Gloves/ box	Price/ box
7570 series	240 / 0.10	924092	924093	924094	924095	924096	100	N/A -

### White range: critical environments

➤ AQL: 1.5

➤ For use in class 100 clean rooms

	Length/ Thickness (mm)	XS (5 - 6)	S (6 - 7)	M (7 - 8)	L (8 - 9)	XL (9 - 10)	Gloves/ box	Price/ box
7595 series	300 / 0.12	924105	924107	924108	924109	924110	100	N/A -



## SHOWA Biodegradable Gloves

SHOWA EBT technology: Eco Best Technology®: same performance, accelerated degradation.  
The EBT® gloves degrade in 1-5 years in active landfills, compared to over 100 years for non-EBT®\* products.



\* according to ASTM D5511 and D5526 test results.

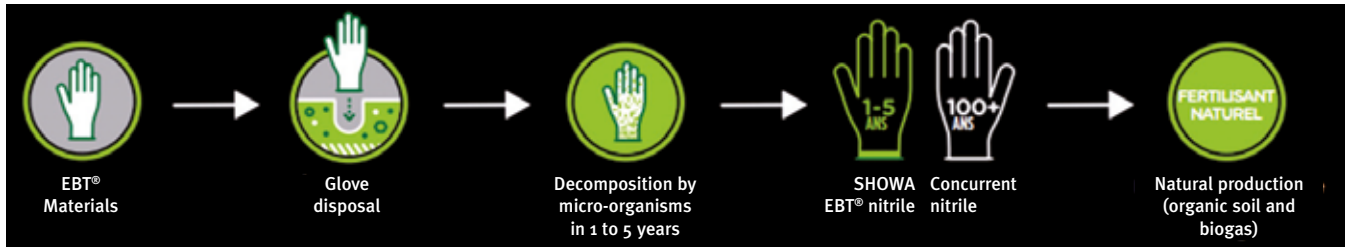

### SHOWA 6110PF



- PPE Cat. III according to Regulation EU/ 2016/425
- Green nitrile, powder-free
- Latex protein free
- Comfortable: soft and second skin-like, easy grip
- Perfect fit for working with complex parts and components, protects against abrasive solvents
- Length 240 mm, thickness 0.10 mm
- Protection against a wide range of chemicals: type B (KPT)
- Biohazard: AQL 0.65
- Protection against infectious agents
- Food contact

	XS (5 - 6)	S (6 - 7)	M (7 - 8)	L (8 - 9)	XL (9 - 10)	XXL (10 - 11)	Gloves/ box	Price/ box
Showa 6110PF	924113	924114	924115	924116	924117	924118	100	N/A -

### SHOWA 6112PF



- PPE Cat. III
- Black nitrile, powder-free
- Latex protein and silicone free
- Length 240 mm, thickness 0.10 mm (palm)
- Food contact
- AQL: 1.5
- Antistatics
- Chemical protection: type B (KPT)
- Protection against infectious agents

	XS (5 - 6)	S (6 - 7)	M (7 - 8)	L (8 - 9)	XL (9 - 10)	XXL (10 - 11)	Gloves/ box	Price/ box
Showa 6112PF	924119	924120	924121	924122	924123	924124*	100	N/A -

\* Size XXL: 90 gloves per box.

### SHOWA 7500PF EBT



- PPE Cat. III according to Regulation EU/ 2016/425
- Blue nitrile, powder-free
- Latex protein free
- Comfortable: soft and second skin-like, easy to put on, easy grip (textured finish)
- Length 240 mm, thickness 0.10 mm
- Protection against a wide range of chemicals: type B (JKPT)
- Biohazard: AQL 1.0
- Protection against infectious agents
- Food contact

XS (5 - 6)	S (6 - 7)	M (7 - 8)	L (8 - 9)	XL (9 - 10)	Gloves/ box	Price/ box	XXL (10 - 11)	Gloves/ box	Price/ box
924125	924126	924127	924129	924130	100	N/A -	924131	90	N/A -

### SHOWA 7502PF EBT



- PPE Cat. III according to Regulation EU/2016/425
- Blue nitrile, powder-free
- No latex proteins and no vulcanisation accelerator
- Comfortable: soft and second skin-like, easy to put on, easy to grip (textured finish)
- Length 240 mm, thickness 0.06 mm
- Biohazard: AQL 1.5
- Protection against infectious agents
- Food contact

XS (5 - 6)	S (6 - 7)	M (7 - 8)	L (8 - 9)	XL (9 - 10)	Gloves/ box	Price/ box	XXL (10 - 11)	Gloves/ box	Price/ box
924132	924133	924134	924135	924136	200	N/A -	924137	180	N/A -





## Touch N Tuff® Gloves



- ▶ Against irreversible risks
- ▶ TNT technology: only 0.12 mm thick
- ▶ Highly resistant, ultra-thin
- ▶ Unparalleled comfort and sensitivity
- ▶ 100% nitrile, no added waxes, silicones or plasticisers
- ▶ Three times the puncture resistance of latex or vinyl
- ▶ Rolled edge
- ▶ Green
- ▶ Lighter and cooler, yet safer and more durable
- ▶ Significantly greater chemical resistance than latex or vinyl (although not designed for immersion in chemicals, it provides significant protection against accidental splashes)
- ▶ Available in powdered and powder-free versions

### Touch N Tuff® Powder Free Gloves 92-600 and 92-605

Disposable - smooth finger tips for 240 mm length; adhered finger tips for 300 mm length.

Size	6 <sup>1</sup> / <sub>2</sub> - 7	7 <sup>1</sup> / <sub>2</sub> - 8	8 <sup>1</sup> / <sub>2</sub> - 9	9 <sup>1</sup> / <sub>2</sub> - 10	Units/box	Price/box
L. 240 mm 92-600	678042	678043	678044	678045	100	N/A -
L. 300 mm 92-605	062099	062100	062101	062102	100	N/A -

### Touch N Tuff® Powder Gloves 92-500

Disposable - Adhered to the fingertips.

Size	6 <sup>1</sup> / <sub>2</sub> - 7	7 <sup>1</sup> / <sub>2</sub> - 8	8 <sup>1</sup> / <sub>2</sub> - 9	9 <sup>1</sup> / <sub>2</sub> - 10	Units/box	Price/box
L. 240 mm	678038	678039	678040	678041	100	N/A -

## Microflex NeoTouch® Gloves



- ▶ Disposable powder-free neoprene gloves
- ▶ 2 lengths: 240 mm and 290 mm
- ▶ Light green
- ▶ Prevention of type I allergies and skin reactions
- ▶ Latex-like comfort
- ▶ More puncture resistance than latex gloves
- ▶ Rolled edge for excellent anchoring
- ▶ Internal polyurethane coating, easy to put on
- ▶ Textured fingertips ensure a secure grip in dry and wet environments
- ▶ Highly resistant to acids, alkalis and alcohols, and to chemical splashes
- ▶ Thickness: 0.13 mm

### NeoTouch® Gloves 25-101 length 240 mm

Size	6 <sup>1</sup> / <sub>2</sub> - 7	7 <sup>1</sup> / <sub>2</sub> - 8	8 <sup>1</sup> / <sub>2</sub> - 9	9 <sup>1</sup> / <sub>2</sub> - 10	Units/box	Price/box
Cat. No.	678059	678060	678061	678062	100	N/A -

### NeoTouch® Gloves 25-201 length 290 mm

Size	6 <sup>1</sup> / <sub>2</sub> - 7	7 <sup>1</sup> / <sub>2</sub> - 8	8 <sup>1</sup> / <sub>2</sub> - 9	9 <sup>1</sup> / <sub>2</sub> - 10	Units/box	Price/box
Cat. No.	678063	678064	678065	678066	100	N/A -

## Chemical protective gloves

SivoChem® 759



Dermatril® P743







Model	Material	Finish	Length / Thickness	Standards	Description/Application	Size	Cat. No.	Units/box	Price/box
SivoChem® 759 CE	Special Nitrile	Rolled edge, non-powdered	390 - 410 mm/ 0.16 mm	  	<ul style="list-style-type: none"> <li>• Disposable protective glove</li> <li>• Good chemical resistance</li> <li>• Very good dexterity</li> </ul>	7	302010	40	N/A -
						8	302011	40	N/A -
						9	302012	40	N/A -
						10	302013	40	N/A -
Dermatril® P743 CE	Special Nitrile	Long cuff, Rolled edge, adhered fingertips, non-powdered	270 - 290 mm/ 0.2 mm	  	<ul style="list-style-type: none"> <li>• Disposable protective glove</li> <li>• Good chemical resistance</li> <li>• Very good dexterity</li> <li>• Tear resistance</li> </ul>	6	302004	50	N/A -
						7	302005	50	N/A -
						8	302006	50	N/A -
						9	302007	50	N/A -
						10	302008	50	N/A -
						11	302009	50	N/A -

## SEMPERGUARD gloves

Simple disposable gloves for everyday use.

- Classified as PPE cat. III according to directive 89/686/EEC
- Ambidextrous
- Complies with EC 1935/2004 for food contact

- Standards displayed: EN 420, EN 374-2 (AQL 1.5), EN 374-3, EN 455
- Latex gloves: good chemical resistance to acrylamide, phosphoric and nitric acids / Nitrile gloves: good chemical resistance to hydroxides, acrylamide

	Model	Material	Finish	Length/ Thickness (mm)	Description	Size	Cat. No.	Units/ box	Price/ box
	Nitrile Xtra Lite	Nitrile	Textured fingers	240 / 0.07	Lavender blue, Very stretchy Powder-free Class I medical device	S	559017	200	N/A -
						M	559018	200	N/A -
						L	559019	200	N/A -
						XL	559020	180	N/A -
	Latex Comfort	Latex	Textured fingers	240 / 0.10	Natural, Chlorinated Excellent elasticity Powder-free Class I medical device	S	559005	100	N/A -
						M	559006	100	N/A -
						L	559007	100	N/A -
						XL	559008	90	N/A -
	Nitrile Comfort	Nitrile	Textured fingers	240 / 0.10	Blue signal Powder-free Class I medical device	S	559013	100	N/A -
						M	559014	100	N/A -
						L	559015	100	N/A -
						XL	559016	90	N/A -
	Latex innercoated	Latex	Textured fingers	240 / 0.24	Natural colour Rolled edge Powder-free Class I medical device	XS	559021	100	N/A -
						S	559022	100	N/A -
						M	559023	100	N/A -
						L	559024	100	N/A -
						XL	559025	90	N/A -

## ULMA® Latex Gloves

- Powder-free, thick latex examination gloves
- Excellent quality
- Ambidextrous
- Low protein levels
- In smooth or textured version
- In non-sterile or sterile versions packed in pairs

### Happy Skin Powder-free gloves smooth surface

Size	XS	S	M	L	XL	Units/ box	Price/ box
Cat. No.	030222	030223	030224	030225	030226	100	N/A -

### Happy Skin Grip powder-free gloves with textured surface

Size	XS	S	M	L	XL	Units/ box	Price/ box
Cat. No.	030222G	030223G	030224G	030225G	030226G	100	N/A -

### Sensiflex Plus sterile gloves in pairs

Size	XS	S	M	L	Units/ box	Price/ box
Cat. No.	-	030256	030257	030258	50 pairs	N/A -





## ULMA® Powder-free nitrile or neoprene gloves



030269B to 030273B  
(non-sterile)



031511 to 031517  
(sterile)

Powder-free nitrile gloves. Sterile powder-free neoprene gloves.

### Pro Free powder-free nitrile gloves

Cat. No.	Size	Texture	Sterile	Units/box	Price/box
030269B	XS	Grip	No	100	N/A -
030270B	S	Grip	No	100	N/A -
030271B	M	Grip	No	100	N/A -
030272B	L	Grip	No	100	N/A -
030273B	XL	Grip	No	100	N/A -

### Nuzone X2 Enhanced sterile powder-free neoprene gloves

Cat. No.	Size	Texture	Sterile	Units/box	Price/box
031511	6	Grip	Yes	50 pairs	N/A -
031512	6.5	Grip	Yes	50 pairs	N/A -
031513	7	Grip	Yes	50 pairs	N/A -
031514	7.5	Grip	Yes	50 pairs	N/A -
031515	8	Grip	Yes	50 pairs	N/A -
031516	8.5	Grip	Yes	50 pairs	N/A -
031517	9	Grip	Yes	50 pairs	N/A -

## ULMA® Vinyl Gloves



030201 to 030202

- ▶ Smooth texture
- ▶ Standard cuff length of 24 cm
- ▶ Recommended for short term use
- ▶ Powdered or non-powdered version



Cat. No.	Size	Powdered	Cuff	Sterile	Units/box	Price/box
030201	M	Yes	24 cm	No	100	N/A -

## WHAT IS AN EXAMINATION GLOVE?

- An examination glove is a disposable glove, registered as a Medical Device (MD) under the European Directive 93/42/EEC
- The purpose of a medical device is to protect the patient. This is a self-certification by the manufacturer
- The mere mention of "medical device" or "examination glove" does not give the glove any particular properties if nothing else is specified



The EN-455 standard allows the performance of examination gloves to be measured and compared between them:

- EN455-1: AQL 1.5 (Acceptable Quality Level) - Statistical Leakage Check
- EN455-2: Definition of physical characteristics, e.g. length (24 cm for an examination glove)
- EN455-3: Biological assessment (measurement of protein levels in latex gloves)

Sources: shieldscientific.fr and ansell.fr

### Medi-Grip PF sterile latex surgical gloves

Powder-free, sterile latex glove, packed in pairs in peel-off paper.

- Low allergenicity
- Length: 285 mm
- Anatomical shape
- Long cuff
- Textured surface



Size	6	6 1/2	7	7 1/2	8	8 1/2	9	Units/box	Price/box
Cat.No.	062028B	062029B	062030B	062031B	062032B	062033B	062034B	50 pairs	N/A -

### GAMMEX Antimicrobial Latex Surgical Gloves

- Active defence surgical glove
- Made of cream natural rubber latex, strong, soft, comfortable
- Unique coating containing chlorhexine gluconate with antimicrobial action in case of glove breakage
- Microrough finish
- Production on anatomical shapes, wider palm on the surface
- Adhesive strip to anchor the cuff
- Brand, size and L (left) or R (right) printed on the cuff for easy identification
- Complies with the requirements of the standards EN 455, ISO 10282 and AS/NZS 4179



Size	5 1/2	6	6 1/2	7	7 1/2	8	8 1/2	9	Units/box	Price/box
Cat.No.	678155	678156	678157	678158	678159	678160	678161	678162	25 pairs	N/A -

### Gammex® Non-latex Neoprene Gloves

Powder-free sterile neoprene surgical gloves with a urethane ionomer inner coating for easy wearing and improved comfort.

- Excellent puncture resistance, good chemical resistance
- Powder-free
- Made of green neoprene, free of accelerators and natural latex
- Sterile
- Anatomical, ambidextrous
- Reinforced cuff without rolled edge
- Smooth surface with textured fingertips, polyurethane coated

Size	5 1/2	6	6 1/2	7	7 1/2	8	8 1/2	9	Units/box	Price/box
Cat.No.	062008B	062009B	062010B	062011B	062012B	062013B	062014B	062015B	50 pairs	N/A -



### Gammex® latex Sterile latex gloves

- Surgical glove
- Very high protection
- High tactile sensitivity
- With thick, and resistant cuff
- Sterile
- Packed in pairs
- Powder-free

Size	5 1/2	6	6 1/2	7	7 1/2	8	8 1/2	9	Units/box	Price/box
Cat.No.	062054B	062055B	062056B	062057B	062058B	062059B	062060B	062061B	50 pairs	N/A -



### Micro-Touch® Affinity® Neoprene Gloves

Powder-free examination gloves.

- In green neoprene
- Ambidextrous, reinforced cuff without rolled edges
- External surface: smooth with textured fingertips
- Internal surface: polyurethane coating
- CE marking - EN 455 parts 1 and 3 - ISO 9002 / EN 46002

Size	S	M	L	XL	Price the box of 100
Cat. No.	062045	062046	062047	062048	N/A -



# EXAMINATION GLOVES

## Micro-Touch® Hydracare® Latex Gloves



- ▶ Powder-free latex examination glove, light green
- ▶ Moisturizing agent leaves skin feeling soft and relaxed
- ▶ Ambidextrous, rolled edges
- ▶ Outer surface: Micro-roughened, treated with silicone, humidifying spray and fragrance oil
- ▶ Internal surface: lightly chlorinated, treated with silicone, humidifier spray and perfumed oil

Size	S	M	L	Price the box of 100
Cat. No.	062050	062051	062052	N/A -

## Synsation Powder-free Vinyl Gloves



- ▶ Powder-free vinyl examination glove
- ▶ With rolled edge cuff
- ▶ Surface for easy handling of the material

Size	6/7	7/8	8/9	9/10	Units/box	Price/box
Cat. No.	062016	062017	062018	062019	100	N/A -

## Examination gloves



- ▶ Nitrile or latex
- ▶ Powder-free

Size	XS	S	M	L	XL	Units/box	Price/box
<b>Nitrile gloves</b>							
Cat. No.	390952	390953	390954	-	390956	200	N/A -
<b>Latex gloves</b>							
Cat. No.	-	390957	390958	390959	390960	100	N/A -

## Gen-X new Generation Nitrile Gloves



- ▶ Blue nitrile gloves
- ▶ Length: 240 mm
- ▶ Thickness: 0.06 mm (palm)
- ▶ AQL: 1.5
- ▶ PPE cat III:
  - EN 374-5: 2016 + virus
  - EN 374-1: 2016 (Type C)
- ▶ DM according to EN 455: 1-4

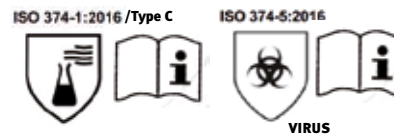

Size	XS	S	M	L	XL	Units/box	Price/box
Cat. No.	603506	603507	603508	603509	603510	100	N/A -

## Vinyl gloves



- ▶ 2 versions available: powdered or powder-free
- ▶ Various sizes (from S to XL)

Size	S	M	L	XL	Units/box	Price/box
<b>Powder-free vinyl gloves</b>						
475000	-	475002	475003		100	N/A -
<b>Powdered vinyl gloves</b>						
475004	475005	475006	475007		100	N/A -



## Sensitex latex gloves



- Powdered or powder-free natural latex
- Rolled edge
- Ambidextrous
- Corn starch powdering
- Complies with CEE 93/42 et 89/686

### Lightly powdered gloves

Size	XS	S	M	L	XL	Units/box	Price/box
Cat. No.	030654	030655	030656	030657	030658	100	N/A -

### Powder-free gloves

Size	XS	S	M	L	Units/box	Price/box
Cat. No.	030659	030660	030661	030662	100	N/A -

## CPE (chlorinated polyethylene) gloves



- Transparent Natural or blue
- Powder-free
- Ambidextrous
- Non-sterile
- Latex and phthalate free
- Suitable for food contact

Size	M	L	XL	Units/box	Price/box
Natural	475051	475066	475067	100	N/A -
Blue	475068	475069	475070	100	N/A -

## Sensinyl vinyl gloves

Vinyl gloves, powder-free.

- Ambidextrous
- Non-sterile
- Polyvinyl chloride

- Tactile comfort
- Hypoallergenic
- Rolled edge

Size	XS	S	M	L	XL	Units/box	Price/box
Cat. No.	030749	030750	030751	030752	030753	100	N/A -

**TIP**



See glove box holders page 1228



## Parmadis powder-free nitrile gloves

- Powder-free nitrile
- Excellent resistance
- Thinness ensures outstanding tactile sensitivity
- Fits perfectly the hand shape
- Eliminate latex allergies
- Superb comfort
- Complies with CEE 93/42 et 89/686

Size	S	M	L	XL	Units/box	Price/box
Cat. No.	030649	030650	030651	030652	100	N/A -



## SENSISKIN nitrile gloves 240 mm

- Blue Nitrile examination gloves, with good chemical aggression resistance and a flexibility allowing a very sensitive touch
- Latex-free
- Powder-free
- Non-sterile

Size	XS	S	M	L	XL	Units/box	Price/box
Cat. No.	794013	794014	794015	794016	794017	100	N/A -



## Nitrile gloves with extra-long cuff



- ▶ Nitrile, non-sterile, non-powdered
- ▶ Ambidextrous
- ▶ With long cuff 400 mm
- ▶ AQL 1.5
- ▶ Complies with European Directive 93/42/EEC Class I, EN 455-1, EN 455-2, ISO 10993-10

Size	M	L	XL	Units/ box	Price/ box
Cat. No.	030774	030775	030776	50	N/A -

## Polyethylene examination gloves



Ambidextrous transparent PE gloves with good tactile sensitivity. Used in communities for hygiene and cleaning.

Cat. No.	Size	Length (mm)	Specifications	Sterile	Units/ box	Price/ box
794030	Standard	300	Packed in pairs	Yes	100	N/A -
794031	Woman	290	Smooth surface	No	100	N/A -
794032	Standard	300	Smooth surface	No	100	N/A -
794033	Standard	500	White	No	50	N/A -
794034	Standard	900	Special vet, orange	No	50	N/A -

## 2-finger "Legueu" type Finger Stalls



- ▶ 2 fingers
- ▶ Medically clean or non-sterile

Cat. No.	Description	Units/ bag/	Bags/ box	Price/ box
030728	Non sterile finger stall	100	100	N/A -
030729	Medically Clean finger stall	100	25	N/A -

## Opaque polyethylene finger stalls



- ▶ 1 or 2 fingers
- ▶ In polyethylene
- ▶ Opaque
- ▶ Highly resistant
- ▶ Available sterilised (in individual cases) or non-sterile

Cat. No.	Size	Sterile	Units/ box	Price/ box
794035	1 finger	No	100	N/A -
794037	1 finger	Yes	100	N/A -

## Antistatic nitrile finger stalls



- ▶ Antistatic, low particle count, powder-free nitrile
- ▶ Thickness: 0.07 mm
- ▶ Length: 70 mm
- ▶ White
- ▶ Complies with USDA, FDA, 21 CFR, food processing regulations

Cat. No.	Description	Units/ bag	Price/ bag
302037	Antistatic nitrile finger stalls	720	N/A -

## MAPA Waterproof Protective Gloves

- For all household work, in contact with liquids that are not chemically aggressive (water, cleaning products)
- The MAPA waterproof range meets the needs of comfort and protection of the hand

**MAPA**  
PROFESSIONAL



VITAL 115



VITAL 117



VITAL 124



JERSETTE  
300



ULTRANITRIL  
454

Model	Material	Int./ ext. finish	Length/ Thickness	Standards	Description / Applications	Size	Cat. No.	Cat. No.	Cat. No.	Packaging unit	Price
							Colour code				
							Vital 115	Vital 117	Vital 124		
<b>VITAL</b>  Cat. 3	Natural latex	Flocking / Anti-slip surface	305 mm / 0.38 mm	Type B   	<b>➔ Description</b> <ul style="list-style-type: none"> <li>The natural flexibility of latex allows excellent dexterity</li> <li>Good mechanical resistance</li> <li>Cotton flock: comfortable to wear</li> <li>Straight cuffed wrist</li> <li>3 colours to choose from</li> </ul> <b>➔ Applications</b> <ul style="list-style-type: none"> <li>Suitable for routine cleaning work, very good sealing, for handling household detergents</li> </ul>	6	430000	430001	430002	Bag of 10 pairs	N/A -
						7	430003	430004	430005		N/A -
						8	430006	430007	430008		N/A -
						9	430009	430010	430011		N/A -
						10	-	430012	430017		N/A -

Model	Material	Int./ ext. finish	Length/ Thickness	Standards	Description / Applications	Size	Cat. No.	Packaging unit	Price
<b>JERSETTE</b> 300  Cat. 3	Natural latex	Textile support/ smooth	290 - 330 mm / 1.15 mm	EN 407  X1XXXX Type B  	<b>➔ Description</b> <ul style="list-style-type: none"> <li>Excellent comfort from the seamless textile material</li> <li>Anatomical shape</li> <li>Mechanical resistance</li> <li>Good chemical resistance to many dilute acids and bases</li> <li>Wrist: scalloped cuff</li> <li>Blue</li> </ul> <b>➔ Applications</b> <ul style="list-style-type: none"> <li>For handling household detergents</li> </ul>	5	430018	Bag of 5 pairs	N/A -
						6	430019		N/A -
						7	430020		N/A -
						8	430021		N/A -
						9	430022		N/A -
						10	430023		N/A -

Model	Material	Int./ ext. finish	Length/ Thickness	Standards	Description / Applications	Size	Cat. No.	Packaging unit	Price
<b>ULTRA NITRIL</b> 454  Cat. 3	Synth. elastomer	Flocking/ Pebbled embossing	310 mm / 0.35 mm	Type B  	<b>➔ Description</b> <ul style="list-style-type: none"> <li>Hypoallergenic</li> <li>Anatomical shape, flocking quality: better comfort</li> <li>Pebbled embossing: good grip</li> <li>Fine touch</li> <li>Wrist: straight cuff</li> <li>Turquoise</li> </ul> <b>➔ Applications</b> <ul style="list-style-type: none"> <li>Common use in hospitals and clinics</li> </ul>	6	430024B	Bag of 1 pair	N/A -
						7	430025B		N/A -
						8	430026B		N/A -
						9	430027B		N/A -
						10	430028B		N/A -



## Latex Household Gloves



- 100% natural latex on cotton flocked jersey
- Compliant with EN 388 and EN 374 standards
- Length: 31 cm

Cat. No.	Description	Price the pair
039669	Household glove, size 7 (medium)	N/A -
039670	Household glove, size 9 (large)	N/A -

## Rubber Household Gloves with long cuff



Natural rubber gloves with extra-long 56 cm cuff.

- Protects hands and arms
- Excellent grip
- Long lasting

Cat. No.	Description	Price the pair
030648	Household glove with long cuff	N/A -

## Sensigloves Wash Gloves

Single use, non-woven wash gloves.



- Composition: 50 % viscose, 50 % polyester
- Dimensions (cm) : 16 x 23
- Sterilisation resistance: autoclave and ethylene oxide

Cat. No.	Description	Units/box	Price/box
030797A	Sensigloves Wash Gloves	50	N/A -

## Disinfectant spray PPE

- For personal protective equipment
- Bactericidal and fungicidal action



Cat. No.	Volume (ml)	Price
280002	405	N/A -

## CleanJet® Automatic sprayer for glove disinfection



Reduces glove consumption.

- 304 AISI stainless steel, brushed steel finish
- Automatic detector that dispenses an alcohol-based disinfectant solution
- Maximum tank capacity 700 ml
- Visual (LED) and audible level indicators

Dimensions L x D x H (mm)	340 x 260 x 290
Weight (kg)	6.3
Tank volume (ml)	700
Frequency (Hz)	50
Power supply	230 V
<b>Cat. No.</b>	<b>103934</b>
<b>Price</b>	<b>N/A -</b>

## WHAT IS A CHEMICAL PROTECTIVE GLOVE?

- In this category, you will find the different PPE gloves that can provide chemical protection, according to the EN 374 standard
- This standard specifies, among other things, the ability of gloves to protect the user against chemicals and/or micro-organisms
- More specifically, EN 374-3 defines a methodology for measuring the permeation time of a chemical through the glove

### KLEENGUARD\* G8o Chemical Protective Gloves

- Features **KLEENGUARD\* G8o NITRILE\* gloves**
- Unique **NITRILE\*** material for excellent chemical resistance and durability
- Natural latex free to reduce the risk of type 1 allergy
- Textured fingertips, thickness 0.38 mm
- Cotton flock lining
- Resistant to oils, greases, acids, caustics and solvents
- Abrasion and puncture resistance
- **KLEENGUARD\* G8o Neoprene/Latex Gloves Specifications**
- Latex and neoprene blend
- Protection against oxidising acids, bases, alcohols, oils, greases and solvents
- Textured fingertips, thickness 0.7 mm
- Cotton flock lining



KLEENGUARD\* G8o  
Neoprene / Latex

#### KLEENGUARD\* G8o NITRILE\* Gloves

Size	7	8	9	10	11	Price 12 pairs
Cat. No.	038992B	038993B	038994B	038995B	038996B	N/A -

#### KLEENGUARD\* G8o Neoprene / Latex Gloves

Size	7	8	9	10	Price 12 pairs
Cat. No.	041428	041429	041430	041431	N/A -

### SOL-VEX® Gloves



- Unsupported nitrile glove
- Non-suede interior finish
- Sanded exterior finish
- 2 lengths: 330 mm or 380 mm
- Colour: green
- Resistant to many solvents
- Excellent flexibility, high comfort
- Good grip thanks to anatomical shape and sandblasted finish
- Sanitized, Actifresh: contains fungicidal and bacteriostatic agents
- Chlorine treatment to improve wet grip and make gloves easier to put on



#### SOL-VEX® 37-675 Gloves 330 mm

Suede - thickness 0.38 mm.

Size	6	7	8	9	10	11	Price the 12 pairs
Cat. No.	678000	678001	678002	678003	678004	678005	N/A -

### Alphatec® 02-100 ex-Barrier® Gloves



A combination of 3 new technologies:

- a 5-layer film that offers resistance to a wide range of chemicals;
- a non-woven backing that has the same profile as the glove to ensure a snug and comfortable fit for both hand and wrist;
- a patented assembly technology that prevents the penetration of chemicals and which makes protective film and its support a single entity.

- **Against irreversible risks**
- **Product resistant film**
- **Ergonomically designed to fit the hand**
- **Integral non-woven backing promotes moisture absorption and wicking for a cooler, more comfortable fit**
- **Resistant to a wide range of chemicals, for handling or cleaning hazardous materials**
- **Thickness: 0.062 mm**



Size Length	6 380 mm	7 380 mm	8 380 mm	9 380 mm	10 410 mm	11 410 mm	Price the pair
Cat. No.	678067	678068	678069	678070	678071	678072	N/A -

## SHOWA PVC gloves



Bo700 L30

Bo710 L60

- ▶ **Unsupported PVC gloves (lint-free), second skin effect**
- ▶ **PPE Cat. III**
- ▶ **Powder-free**
- ▶ **Thickness: 0.30 mm**
- ▶ **Excellent chemical protection**
- ▶ **Waterproof, recommended for work in wet or greasy environments**
- ▶ **Textured finish for a good grip**
- ▶ **White**



S/7	M/8	L/9	XL/10	Units/ box	Price/ box
-----	-----	-----	-------	---------------	---------------

SHOWA Gloves PVC Bo700 clean white L30  
length 300 mm

924036	924037	924038	924039	10 pairs	N/A -
--------	--------	--------	--------	----------	-------

SHOWA Gloves PVC Bo710 long clean white L60  
length 600 mm - welded-in sleeve with elasticated edge -  
suspension eyelet

924040	924041	924042	924043	10 pairs	N/A -
--------	--------	--------	--------	----------	-------





## MAPA Chemical Protective Gloves

➤ A glove for every risk, choose from our selection of MAPA chemical protection gloves in latex, nitrile, neoprene or butyl



Model	Material	Interior finish	Length/Thickness	Standards	Description / Applications	Size	Bag 1 pair		Bag 10 pairs		Bag of 10 pairs length 370 mm	
							Cat. No.	Price	Cat. No.	Price	Cat. No.	Price
ALTO 285  CE Cat. 3	Natural latex	Chlorinated / Reinforced Grip	600 mm / 1.00 mm	 Type A ABKMPT   2131X	➔ <b>Description</b> <ul style="list-style-type: none"> <li>Optimised life span, good protection against knocks and shocks thanks to the thickness</li> <li>Extended forearm protection</li> <li>Rolled edge cuff</li> </ul> ➔ <b>Applications</b> <ul style="list-style-type: none"> <li>Suitable for maintenance work in wet environments (water, oil, grease, hydrocarbons)</li> </ul>	8	430119	N/A	-	-	-	-
						9	430120	N/A	-	-	-	-
						10	430121	N/A	-	-	-	-
ULTRA NITRIL 492 & 491  CE Cat. 3	Nitrile	Flocking/ Pebbled embossing	320 mm / 0.38 mm  370 mm / 0.38 mm	 Type A AIKOPT   4102X	➔ <b>Description</b> <ul style="list-style-type: none"> <li>Anatomical shape of the glove and the quality of the flocking: dexterity and comfort</li> <li>Superior durability and mechanical resistance</li> <li>Wrist: straight cuff</li> </ul> ➔ <b>Applications</b> <ul style="list-style-type: none"> <li>Can be used in the presence of cutting oil, various solvents, paints and varnishes, PVC-based adhesives, coatings, sealants, detergents</li> <li>Suitable for a variety of uses in the mechanical, chemical and municipal industries</li> </ul>	6	430029B	N/A	430029	N/A	430035	N/A
						7	430030B	N/A	430030	N/A	430036	N/A
						8	430031B	N/A	430031	N/A	430037	N/A
						9	430032B	N/A	430032	N/A	430038	N/A
						10	430033B	N/A	430033	N/A	430039	N/A
						11	430034B	N/A	430034	N/A	-	-
ULTRA NITRIL 480  CE Cat. 3	Nitrile	Chlorinated/ Pebbled embossing	460 mm / 0.55 mm	 Type A AIKOPT   4102X	➔ <b>Description</b> <ul style="list-style-type: none"> <li>Optimised service life, good mechanical resistance (abrasion, puncture)</li> <li>Good grip on slippery objects thanks to the pebbled embossing</li> <li>Wrist: straight cuff</li> </ul> ➔ <b>Applications</b> <ul style="list-style-type: none"> <li>Provides effective protection for intensive use of high-risk chemicals</li> </ul>	7	430115B	N/A	-	-	-	-
						8	430116B	N/A	-	-	-	-
						9	430117B	N/A	-	-	-	-
						10	430118B	N/A	-	-	-	-
ULTRA NEO 420  CE Cat. 3	Neoprene	Flocking/ Pebbled embossing	310 mm / 0.75 mm	 Type A ALMNST   2121X	➔ <b>Description</b> <ul style="list-style-type: none"> <li>Flexibility of neoprene, comfort of flocking for an easier movement</li> <li>Good grip thanks to the pebbled embossing.</li> <li>Wrist: straight cuff</li> </ul> ➔ <b>Applications</b> <ul style="list-style-type: none"> <li>Suitable for handling many chemicals, industrial cleaning and glue work</li> </ul>	6	-	-	430122	N/A	-	-
						7	-	-	430123	N/A	-	-
						8	-	-	430124	N/A	-	-
						9	-	-	430125	N/A	-	-
						10	-	-	430126	N/A	-	-
BUTOFLEX 650  CE Cat. 3	Butyl	Supported textile/ Anti-slip surface	350 mm / 1.5 mm	 Type A ABCILMNOS   1121X	➔ <b>Description</b> <ul style="list-style-type: none"> <li>Exceptional comfort, thanks to MAPA textile support technology</li> <li>Very resistant glove suitable for many uses</li> <li>Wrist: scalloped cuff</li> </ul> ➔ <b>Applications</b> <ul style="list-style-type: none"> <li>Excellent chemical resistance to highly corrosive acids, ketones, esters and amine derivatives Suitable for use in the cosmetic and pharmaceutical industries, as well as in the laboratory</li> </ul>	7	430047	N/A	-	-	-	-
						8	430048	N/A	-	-	-	-
						9	430050	N/A	-	-	-	-
						10	430051	N/A	-	-	-	-
						11	430054	N/A	-	-	-	-

## Cotton knitted gloves



High quality cotton gloves in natural colours.  
 • Lightweight cotton, length 215-235 mm.



Size	7	9	Price the 12 pairs
Lightweight cotton	678116	678118	N/A -

## Sufracold gloves



- ▶ In Lycra® polypropylene
- ▶ For small manipulations in cold environments
- ▶ Can be used as an underglove
- ▶ Tight mesh, perfect fit, limited dirt penetration
- ▶ Blue
- ▶ Length: 23 cm
- ▶ One size fits all
- ▶ Category I minor risks, according to EN 420-94

Cat. No.	Description	Price the pair
302054	Sufracold glove	N/A -

## Cotton mitt



- ▶ Polyester/cotton interlock jersey glove
- ▶ Ambidextrous, flat cut, ecru ribbed cuff
- ▶ One size fits all
- ▶ PPE - Category I - minor risks

Cat. No.	Description	Price the pair
940115	Interlock jersey mitt - one size	N/A -

## WHAT IS A MECHANICAL PROTECTION GLOVE?

The "mechanical risks" pictogram is accompanied by a 4-digit code, according to the standard EN 388:2003. EN 388:2016 standard introduces two new factors (E and F) to measure the mechanical strength of gloves according to EN ISO 13997. In all cases, o indicates the lowest level of performance.



Tests	Performance levels					
	0	1	2	3	4	5
A. Resistance to abrasion (cycles)	< 100	100	500	2000	8000	-
B. Blade cut resistance (factor)	< 1.2	1.2	2.5	5.0	10.0	20.0
C. Tearing resistance (Newton)	< 10	10	25	50	75	-
D. Puncture resistance (Newton)	< 20	20	60	100	150	-
E. Cut resistance according to ISO standard (Newton)	A /2	B /5	C /10	D /15	E /22	F /30
F. Impact protection according to EN standard	Success (P) or failure (no marking)					

Level X: the test is not applicable or the glove has not been tested. Sources: shieldscientific.fr and ansell.fr

## Jackson Safety\* G40 Gloves

Handling gloves for mechanical tasks.  
Nitrile foam-coated gloves



- **PURPLE NITRILE\*** foam coating for high durability
- High tactile sensitivity for good dexterity
- **EN 388: 4131**
- Excellent grip in both wet and dry conditions
- Palm protection against non-acidic solutions (gloves are not intended as protection against liquid chemicals)
- Knitted structure, black nylon
- Seamless design for better comfort

Size	7	8	9	10	11	Price the 12 pairs
Cat. No.	038964	038965	038966	038967	038968	N/A -



## MAPA Cut resistant gloves



Model	Material	Interior finish	Exterior finish	Length (mm)	Standards	Description / Applications	Size	Cat. No.	Packaging unit	Price
<b>KRYTECH</b> 586  Cat. 2	Polyur-ethane	Seamless, knitted, in HDPE fibre	PU palm and finger finish	240 to 300 mm (depending on size)	 4x43D ISO 13997 18N(1835g)	➔ <b>Description</b>	6	430040	Bag of 12 pairs	N/A -
						• Comfort and protection against the risk of cuts	7	430041		N/A -
						• Knitted cuff	8	430042		N/A -
						➔ <b>Applications</b>	9	430043		N/A -
						• Particularly suitable for fine handling in low-dirt environments	10	430044		N/A -
	11	430045	N/A -							



# MECHANICAL PROTECTION GLOVES: CUT, ABRASION, TEAR

## SHOWA B0500 palm fit white gloves

EN 388:2003  
3131



- Seamless nylon/polyester knitted gloves
- Polyurethane coated palm
- Without natural latex
- Abrasion and tearing resistance

Size	S/6	M/7	L/8	XL/9	XXL/10	Price the 10 pairs
Length (mm)	205	230	240	260	275	
Cat. No.	924004	924005	924006	924007	924008	N/A -

## SHOWA HPPE Palm fit gloves

EN 388:2003  
4241



- Anti-cut and anti-abrasion.
- Made of HPPE with polyurethane coating
- Minimal risk of allergy
- Breathable back of the hand
- Length 210 - 260 mm, depending on size
- Standard EN 388-2003 4241

Size	6/S	7/M	8/L	9/XL	10/XXL	Units/box	Price/box
Cat. No.	924052	924053	924054	924055	924056	10 pairs	N/A -



## Mechanical protection gloves



GemoMech® 664



GemoMech® 665+

Model	Material	Finish	Length/Thickness	Standards	Description/Application	Size	Cat. No.	Price the pair
GemoMech® 664	Nitrile, polyamide Nitrile foam	Different color border depending on the size	215 to 270 mm/ 1.3 mm		<ul style="list-style-type: none"> <li>• Good grip on wet and oily parts</li> <li>• Very good dexterity</li> <li>• Excellent mechanical resistance</li> </ul>	6	302014	N/A -
						7	302015	N/A -
						8	302016	N/A -
						9	302017	N/A -
						10	302018	N/A -
GemoMech® 665+	Nitrile, polyamide/ Dots: nitrile, foam nitrile	Different color border depending on the size	215 to 270 mm/ 1.3 mm		<ul style="list-style-type: none"> <li>• Good grip on wet and oily parts</li> <li>• Very good dexterity</li> <li>• Excellent mechanical resistance</li> </ul>	11	302019	N/A -
						6	302020	N/A -
						7	302021	N/A -
						8	302022	N/A -
						9	302023	N/A -
						10	302024	N/A -
11	302025	N/A -						

## SHOWA 381 Gloves

EN 388-2003



Non-slip (oil-resistant grip).

- Polyester and microfibre spandex coating, microporous foamed nitrile lining
- Heat dissipation through micropores and sweat absorption through microfibres
- Excellent tactile sensitivity: 0.84 mm thick at the fingers
- Length 220 - 260 mm, depending on size
- Standard EN 388-2003 4121

Size	6/S	7/M	8/L	9/XL	Units/box	Price/box
Cat. No.	924061	924062	924063	924064	10 pairs	N/A -

## Hexarmor needle stick resistant arm guard



Cuff with SuperFabric insert needle stick resistant, all around the forearm.

- Does not slip while working
- Spandex cuff with thumb hole
- Lightweight and less hot than leather or Kevlar cuffs
- Ambidextrous, sold individually
- EN 388: 4501

Size	7	8	9	10
Cat. No.	790056	790057	790058	790059
Price	N/A -	N/A -	N/A -	N/A -

## PicGuard™ Needle stick Undergloves

- High performance thin glove with needle stick resistance
- Low thickness (0.5 mm) and flexibility for good tactile sensitivity
- Length: 270 mm
- PPE cat. II, CE marking, EN 388: 4444, ASTM 1342
- Can be worn alone or as an underglove
- Breathable, lightweight, washable



### Composition

- Made of coolmax polyester (lightness, breathability)
- One-piece protective layer: polyester-viscose (anti-bacterial and thermo-regulating), para-amide (cut resistant), polyurethane and ceramic coating (needle stick & puncture resistant)

Size	S (7)	M (8)	L (9)	XL (10)	Price the pair
Cat. No.	828382	828383	828384	828385	N/A -



## WHAT IS A THERMAL PROTECTION GLOVE - COLD ?

The EN 511 standard applies to all gloves that protect the hands against convective and contact cold down to -50 °C. The pictogram "risk by cold" is accompanied by a 3-digit number.



Tests	Performance levels					
	0	1	2	3	4	5
<b>A. Convective cold resistance:</b> convective cold transfer (thermal insulation in m <sup>2</sup> , °C/W)		≥ 0.10	≥ 0.15	≥ 0.22	≥ 0.30	-
<b>B. Resistance to contact cold:</b> thermal resistance on contact with a cold object (thermal resistance in m <sup>2</sup> , °C/W)		≥ 0.025	≥ 0.050	≥ 0.100	≥ 0.150	-
<b>C. Water permeability</b> after 30 min. exposure	Water penetration	No water penetration	-	-	-	-

Level X: the test is not applicable or the glove has not been tested.

## WHAT IS A THERMAL-HOT PROTECTION GLOVE?

The standard EN 407: 2004 defines the requirements and test methods against thermal, heat and/or fire hazards. The pictogram is accompanied by 6 numbers illustrating the level of protection: index from 0 to 4.



Tests	Performance levels				
	0	1	2	3	4
<b>A. Flammability / fire behaviour resistance:</b> flame persistence time (s.), the time during which the material remains ignited and then continues to burn after the source of ignition has been removed		≤ 20 s	≤ 10 s	≤ 3 s	≤ 2 s
<b>B. Contact heat resistance:</b> temperature at which the wearer of the gloves will not feel any pain for a period of at least 15 s.		100 °C	250 °C	350 °C	500 °C
<b>C. Convective heat resistance:</b> heat transfer in seconds, time during which the glove is able to delay the heat transfer of a flame		≥ 4 s	≥ 7 s	≥ 10 s	≥ 18 s
<b>D. Radiant heat resistance:</b> heat transmission in seconds, the time during which the glove is able to delay heat transfer when exposed to a radiant source		≥ 5 s	≥ 30 s	≥ 90 s	≥ 150 s
<b>E. Resistance to small splashes of molten metal:</b> amount of molten metal required to achieve a temperature rise of 40 °C (number of drops)		≥ 5	≥ 15	≥ 25	≥ 35
<b>F. Resistance to large splashes of molten metal</b> mass (g) of molten metal required to cause a superficial burn		≥ 30 g	≥ 60 g	≥ 120 g	≥ 200 g

Level X: the test is not applicable or the glove has not been tested. Sources: shieldscientific.fr and ansell.fr

## MAPA Thermal protection gloves

► For all work requiring protection against extreme temperatures



TEMPDEX 710



TEMPDEX 720



TEMPCOOK 476

Model	Material	Interior finish	Length/Thickness	Standards	Description / Applications	Size	Cat. No.	Packaging unit	Price
TEMPDEX 710 CE Cat. 2	Nitrile sand	Knitted seamless/ Nitrile coating and dot embossing on palm and fingers	240 to 280 mm (depending on size)	4111X X1XXXX	<ul style="list-style-type: none"> <li>► <b>Description</b></li> <li>• Dexterity assured: thinness and anatomical shape of the glove</li> <li>• Superior durability: excellent abrasion resistance</li> <li>• Special Nitrile Grip coating for medium oily environments</li> <li>• Knitted cuff</li> <li>► <b>Applications</b></li> <li>• For handling hot items (maximum recommended temperature: 125 °C) and slightly oily</li> <li>• Protects against cuts (720 only)</li> </ul>	7	430127B	Bag of 10 pairs	N/A -
						9	430056B		N/A -
						11	430057B		N/A -
TEMPDEX 720 CE Cat. 2	Nitrile sand	Seamless knitted made from aramid fibres/ Nitrile coating, dot embossing on palms and fingers	240 to 280 mm (depending on size)	4343B X2XXXX	<ul style="list-style-type: none"> <li>► <b>Description</b></li> <li>• thermal protection up to 250 °C</li> <li>• Washable, resistant to oils, greases and major detergents.</li> <li>• Sizes: 9 = small, 11 = medium, 12 = large. Allow two extra sizes for the inner thickness.</li> <li>► <b>Applications</b></li> <li>• Autoclaves and food processing applications</li> </ul>	7	430058	Bag of 12 pairs	N/A -
						9	430059		N/A -
						11	430060		N/A -
TEMPCOOK 476 CE Cat. 3	Nitrile	Thermal protection knit / Anti-slip surface	450 mm	4443D X2XXXX 111 Type A AFGJOT	<ul style="list-style-type: none"> <li>► <b>Description</b></li> <li>• thermal protection up to 250 °C</li> <li>• Washable, resistant to oils, greases and major detergents.</li> <li>• Sizes: 9 = small, 11 = medium, 12 = large. Allow two extra sizes for the inner thickness.</li> <li>► <b>Applications</b></li> <li>• Autoclaves and food processing applications</li> </ul>	7	430058B	Bag of 1 pair	N/A -
						9	430059B		N/A -
						11	430060B		N/A -
						12	430130B	Bag of 1 pair	N/A -

## Heat Protection Gloves



- Heat resistant, protection up to 370 °C
- Low thermal conductivity
- Double layer, knitted
- Washable, non-shrinking
- Good chemical resistance
- In nomex, asbestos-free
- Also suitable for use at low temperatures
- Available in 3 sizes and 2 lengths (30 or 52 cm)
- Tested against EN388 (1, x 4, x) and EN 407
- CE marking

Size	Gloves L = 30 cm	Price the pair	Gloves L = 52 cm	Price the pair
Small	446650	N/A -	446654	N/A -
Medium	446651	N/A -	446655	N/A -
Large	446652	N/A -	446656	N/A -
Extra Large	446653	N/A -	446657	N/A -



## High temperature protective gloves

Insulating gloves for handling hot objects (from the oven, autoclave, drying ovens). Protection up to 232 °C.

- ▶ Asbestos-free
- ▶ Made of washable cotton
- ▶ Orange
- ▶ One size fits all

Cat. No.	Cuff length (cm)	Total length (cm)	Price the pair
045888	13	33	N/A -
045889	28	47	N/A -

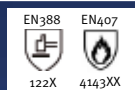

## SHOWA insulated nitrile foam grip gloves

Cold protection and anti-slip (oil resistant grip).

- ▶ Knitted polyester/nylon, acrylic lining with nitrile coating
- ▶ Seamless knitting
- ▶ Waterproof, well protected wrist
- ▶ Length 250 - 280 mm, depending on size



Size	7/M	8/L	9/XL	10/XXL	Units/box	Price/box
Cat. No.	924057	924058	924059	924060	5 pairs	N/A -



## SHOWA TEMRES Gloves

Protection against the cold while being breathable.

- ▶ Nylon and acrylic lining, with polyurethane coating
- ▶ Waterproof
- ▶ Breathable membrane between the coating and the lining
- ▶ Length 270 - 280 mm, depending on size
- ▶ Standard EN 420 EN 388-2003 4221 EN 551-2006 021



Size	8/M	9/L	10/XL	11/XXL	Units/box	Price/box
Cat. No.	924048B	924049B	924050B	924051B	10 pairs	N/A -



## Versa-Touch® Gloves

Blue thermal protection gloves made of acrylic spandex, PVC coating with knitted wrist cuff.

- ▶ Acrylic support: comfort and thermal insulation
- ▶ Applications: biotechnology and food industry (storage, handling and transport of frozen products)
- ▶ For use as under-gloves in meat/fish processing operations
- ▶ Micro-dot embossing on the palm ensure a good grip
- ▶ If worn as an underglove: cut protection
- ▶ Protection against contact cold: level 1
- ▶ Latex-free: no risk of type I allergies



Cat. No.	Length (mm)	Support	Coating	Cuff	Size EN	Price the pair
678229	230	Acrylic	PVC	Knitted cuff	7	N/A -
678230	260	Acrylic	PVC	Knitted cuff	9	N/A -



## Versilic® Protective Mitt

- ▶ CE compliant
- ▶ Easy to handle
- ▶ Use up to 200 °C
- ▶ Protects hands from extreme temperatures when handling
- ▶ Dot embossing provides a good grip



Cat. No.	Description	Price
260426	Protective mitt made of Versilic®	N/A -



## Grabbit Silicone Mitt

- ▶ For use from - 57 °C to + 260 °C
- ▶ Dot embossing for a better grip

Cat. No.	Description	Total length (mm)	Price
037961	Grabbit protective mitt	177 x 100 x 32	N/A -



## VICOLAB Thermal Resistant Gloves



- Temperature resistant from -60 °C to 300 °C
- Silicone, flexible
- Machine washable
- Length 37 cm
- Watertight

	White	Light blue	Black	Price
Cat. No.	041350	041351	041352	54.99 -

## Cryoprotective apron



100% waterproof apron for protection against liquid nitrogen splashes in cryogenic atmosphere.

- Reversible
- Adjustable neck and waist cords

Cat. No.	Length	Price
035832	0.1 m	N/A -
035533	1.6 m	N/A -
035535	1.1 m	N/A -
035534	1.7 m	N/A -

## Cryogloves



Gloves for protection against very low or hot temperatures, consisting of a nylon outer shell and a polyester-cotton liner protected by a polyolefin film.

- Flexible, comfortable, warm, even after prolonged exposure to the cold
- Machine washable and dryable

### ➤ 2 models for 2 types of use

Model	Standard	Waterproof
Applications	Ultra-cold Very low temperature freezer Cold room Handling of dry ice	Cryogenic atmosphere Atmosphere or liquid nitrogen environment Coolant bars Cryogenic grinding

### ➤ 5 finger glove in 4 lengths

- Wrist: 30 cm
- Mid-forearm: 38 cm
- Elbow: 50 cm
- Shoulder: 68 cm

NB: Never dip the glove directly into liquid nitrogen.



Wrist

Mid forearm



Elbow

Shoulder

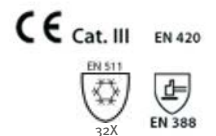

Model	Standard				Price the pair	Waterproof				Price the pair
	Small (S)	Medium (M)	Big (L)	Extra large (XL)		Small (S)	Medium (M)	Big (L)	Extra large (XL)	
5 finger glove 30 cm	035501	035502	035503	035504	N/A -	035517	035518	035519	035520	N/A -
5 finger glove 38 cm	035505	035506	035507	035508	N/A -	035521	035522	035523	035524	N/A -
5 finger glove 50 cm	035509	035510	035511	035512	N/A -	035525	035526	035527	035528	N/A -
5 finger glove 68 cm	035513	035514	035515	035516	N/A -	035529	035530	035531	035532	N/A -

## Cold protection gloves



- For use with material stored in liquid nitrogen or at low temperature
- Very good insulation, thinner gloves allowing great dexterity
- Synthetic fibre for better flexibility
- Water resistant
- Waterproof coating
- With suspension ring
- CE marking

Size	Gloves L = 37 cm	Price the pair	Gloves L = 50 cm	Price the pair	Gloves L = 60 cm	Price the pair
Small	446658	N/A -	446662	N/A -	446670	N/A -
Medium	446659	N/A -	446663	N/A -	446671	N/A -
Large	446660	N/A -	446664	N/A -	446672	N/A -
Extra Large	446661	N/A -	446665	N/A -	446673	N/A -

## AIR LIQUIDE cryo gloves and protective apron

### AIR LIQUIDE Cryo Gloves

Protective gloves against mechanical risks, industrial cold and gas projections.

- Made of blue water-repellent full grain leather 1 mm thick
- Lined with wool fleece
- CE marking
- EN 420: general requirements, dexterity
- EN 388: mechanical risks, abrasion, blade cut, puncture.



Size	Small (Size 8)	Medium (Size 9)	Large (Size 10)	Extra large (Size 11)
Cat. No.	082661	082662	082663	082664

### AIR LIQUIDE protective apron

- Made of siliconized cotton
- Against the risk of liquefied gas splashing
- To be combined with gloves

Cat. No.	Description	Price
082665	Protective apron (one size fits all)	N/A -



## Cryokit protective equipment

- **Cryokit gloves, waterproof and breathable, triple layer**
  - Cryokit gloves - Premium range: top of the range cryogenic gloves in black/blue waterproof multilayer fabric (240 g/m<sup>2</sup>)
  - Cryoplus gloves - Standard range: cryogenic gloves in blue waterproof fabric, multilayer protection
- **Face Shield and Goggles**
  - Clear-Cryo\*: heavy duty Face Shield with adjustable harness and rigid polycarbonate shield, tested for liquid nitrogen
  - Vision-Cryo\*: goggles
  - \*tested for liquid nitrogen
- **Aprons**
  - Cryo-Light: in blue wax effect fabric, waterproof
  - Cryo-Plus: in blue waterproof fabric

### TRIPLE LAYER GLOVES

- Waterproof
- Watertight
- Breathable

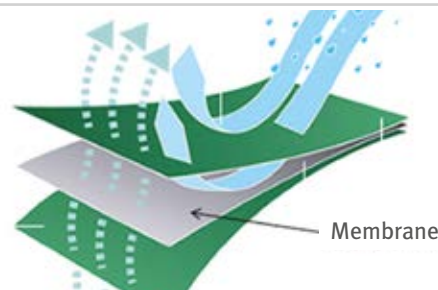

### Cryokit Case



- Standard size case, grey plastic
- Protection, flexibility and dexterity from -196 °C to +150 °C
- **Kit Contents:**
  - 1 pair of gloves
  - 1 Cryo-light apron 90 cm
  - 1 pair of overshoes
  - 1 Clear-Cryo Face Shield
  - 1 Cryokit carrying case

Gloves	Length (cm)	Size 8	Size 9	Size 10	Price per pair
CryoPlus 2.0	38	005259	005260	005261	N/A -
CryoPlus 2.1	38	005264	005265	005266	N/A -
CryoPlus 2.1	45	005269	005270	005271	N/A -
CryoPlus 2.1	55	005273	005274	005275	N/A -
CryoPlus 2.1	65	005277	005278	005279	N/A -
Cryokit 400	40	005282	005283	005284	N/A -
Cryokit 550	55	005286	005287	005288	N/A -

### Bluebox case



- Blue plastic slim suitcase
- Fleece inner insulation, very soft glove
- Protection, flexibility and dexterity from -196 °C to +150 °C
- **Kit Contents:**
  - 1 pair of gloves
  - 1 Cryo-Plus apron 90cm
  - 1 pair of Vision-Cryo protection goggles
  - 1 Bluebox carrying case

Gloves	Length (cm)	Size 8	Size 9	Size 10	Price per pair
CryoPlus 2.0	38	005297	005298	005299	N/A -
CryoPlus 2.1	38	005302	005303	005304	N/A -
CryoPlus 2.1	45	005307	005308	005309	N/A -
CryoPlus 2.1	55	005311	005312	005313	N/A -
CryoPlus 2.1	65	005315	005316	005317	N/A -
Cryokit 400	40	005320	005321	005322	N/A -
Cryokit 550	55	005324	005325	005326	N/A -



## ENDOproteclab Disposable masks



- ▶ Polypropylene non-woven 2-layer 25 g/m<sup>2</sup> and filter layer
- ▶ One size fits all: 175 x 95 mm with elastic band and integrated nose bridge
- ▶ With CE marking

Colours	White	Green	Units/box	Price/box
Cat. No.	942690	942691	50	N/A -

## Economical Paper Mask



Filter paper mask with elastic band. 2-ply.

Cat. No.	Description	Units/box	Price/box
030653B	Paper Mask - 2 ply	100	N/A -

## 3-ply masks with elastic or ties



3-ply non-woven polypropylene mask with elastic or ties.

- ▶ 0.3 cm aluminium nose bridge
- ▶ Green
- ▶ High filtration capacity

Cat. No.	Description	Units/box	Price/box
030698	3-ply green mask with ear band	50	N/A -
030756	3-ply green mask with ties	50	N/A -

## Aérokyn® High Filtration Mask



Non-sterile high filtration mask with ear elastics, 3-ply, Type II.

- ▶ Standard EN 14683
- ▶ Bacterial and viral filtration efficiency: EFB ≥ 98 %
- ▶ Differential pressure: DP < 29.4 Pa
- ▶ Without glass fibre
- ▶ Ultrasonic welding assembly
- ▶ Odourless, latex-free
- ▶ Aluminium nose bridge

Cat. No.	Description	Units/box	Price/box
030780	Aérokyn®masks, high filtration	50	N/A -

## Fluidshield® Masks



Masks with high bacterial filtration capacity, lined with an air-permeable film and protecting against splashes.

- ▶ Non-allergenic, liquid repellent
- ▶ With or without transparent panoramic shield for eye protection against splashes

Cat. No.	EFP* (µm)	EFB** (µm)	Binding	Liquid resistance	Shield	Units/box	Price/box
062001	0.1	3	Earloop Spandex	Yes	No	40	N/A -
062002*	0.1	3	Earloop Spandex	Yes	Yes	25	N/A -
062003	0.1	3	Polypropylene Tie	Yes	No	50	N/A -

\*EFP: particle retention \*\*EFB: bacteria retention

## Spandex® High Filtration Masks



- ▶ "Non-woven" mask
- ▶ Non-irritating, latex-free
- ▶ Filtration power greater than 99.2%
- ▶ Great comfort
- ▶ Easier to breathe

Cat. No.	EFP* (µm)	EFB** (µm)	Binding	Liquid resistance	Colours	Units/box	Price/box
062104	0.1	3	Earloop Spandex®	No	Blue	50	N/A -
062105	0.1	3	Polypropylene Tie	No	Blue	50	N/A -

\*EFP: particle retention \*\*EFB: bacteria retention

## 3-layer Mask with Shield



- ▶ Anti-fog visor
- ▶ Surgical quality
- ▶ Earloop or tie
- ▶ In a dispenser box of 25 masks

Colour	Elastic		Tie	
	Cat. No.	Price 25 units	Cat. No.	Price 25 units
White	683515	N/A -	-	-
Blue	683516	N/A -	683519	N/A -
Green	683517	N/A -	683520	N/A -
Green	030844	N/A -	-	-

## Shell Mask



Polyester fibre mask with elastic adhesive tape and aluminium nose bridge. Filtration rate: 95 %.

Cat. No.	Description	Units/box	Price/box
030618	Shell Mask	50	N/A -

## FluidShield® PFR95® Respirator mask

- Respirator mask and surgical mask. **> Orange**
- > Polyurethane tie** **> Non-sterile, single use**
  - > Nose bridge** **> Latex-free**
  - > EFP: 1 µm / EFB: 3 µm** **> Dimensions: 253 x 100 mm**



Cat. No.	Description	Units/box	Price/box
062004	FluidShield® PFR95® Respirator Mask, N95	35	N/A -

## Foldable hygiene mask

- > Made of polypropylene with elastic support**
- > In a dispenser box of 50 masks**

Cat. No.	Colours	Price 50 units
683521	White	N/A -



## Duckbill Face Mask Respirator

- > Single use, without breathing valve**
- > Particle filtering half mask - designed to protect against solid and liquid aerosols**
- > Latex-free elastic ties**
- > 4 layers of polypropylene, one of which is a melt-blown filter layer**
- > Soft nose bridge**
- > Recommended wearing time: 4 hours**
- > Classified as FFP2, in accordance with the European standard EN 149:2001**
- > CE marking according to the European 89/686/EEC (SGS)**

Cat. No.	Description	Units/box	Price/box
030782	Duckbill Mask	100	N/A -



## SAFEMASK PREMIUM Face Masks Respirators

- > Single-use masks protecting against solid and liquid particles**
- > PPE Cat. III**
- > Double certification PPE and DM class I, type IIR (FFP1 and FFP2 masks): EFB > 98 %; microbial cleanliness ≤ 30CFU/g**
- > PP non-woven filter material**
- > Polypropylene and metal nose bridge, ultrasonically welded**
- > Synthetic elastic double ties**

White	Colour Blue	Filtration level	Packaging	Price the box of 50
-	475221	FFP1 NR D	In dispenser box	N/A -
475222	475223	FFP1 NR D	Individual bag packaging	N/A -
475217	475216	FFP2 NR D	In dispenser box	N/A -
-	475225	FFP2 NR D	Individual bag packaging	N/A -



## SterØmask - UV disinfection unit for surgical masks and FFP2

- > Extends the life of single-use masks without valves**
- > Up to 4 treatments per mask**
- > Ultra fast disinfection, automated treatment and continuous UV-C dose control**
- > Viral and bacteriological disinfection in 1 minute for a pleated mask**
- > Viral and bacteriological disinfection in 3 minutes for a FFP2 mask**
- > 99.99% inactivation of viruses and bacteria**
- > Disinfection in 1 min, sterilisation in 3 min.**
- > With a specially designed holder for optimal mask attachment**
- > Precise and reproducible positioning in height, width and depth**
- > Adapts to the geometry of each type of mask, ensures proper tension of the entire mask surface**
- > Quick and easy installation at no cost**
- > Use up to 25 000 cycles**

Material	Stainless steel
Dim. L x D x H (mm)	450 x 350 x 350
UV wavelength (nm)	254
Rated voltage	220 V / 50 Hz
Power (W)	150
Weight (kg)	15
COVID-19 Disinfection time	< 1 min.
Sterilisation time	< 3 min.
Cat. No.	005550
Price	N/A -



## MOLDEX dust and smoke masks

- FFP shell masks, proven and durable
- Made in Europe
- DuraMesh® design: strong and durable, keeps mask in shape

- ActivForm® technology: no nose clip required
- Masks have passed the Dolomite clogging test, certified to EN 149:2001+A1:2009

### Classic Series



- Loop strap for quick, simple and safe on and off

Cat. No.	Protection Level	Valve	Units/box	Price/box
265021	FFP1 NR D	Without	20	N/A -
265022	FFP1 NR D	Ventex®	20	N/A -
265025	FFP2 NR D	Without	20	N/A -
265004	FFP2 NR D	Ventex®	20	N/A -
265029	FFP3 NR D	Ventex®	20	N/A -

### Smart Series



- Loop strap with clip, quick and easy to put on and take off
- Comfortable nose seal

\* acid gases \*\* acid gases + ozone

Cat. No.	Protection Level	Valve	Units/box	Price/box
265023	FFP1 NR D	Ventex®	20	N/A -
265026	FFP2 NR D	Ventex®	20	N/A -
265005	FFP3 NR D	Ventex®	10	N/A -
265006	FFP2 NR D + gas* † TLV (activated carbon)	Ventex®	10	N/A -
265093A	FFP2 NR D + ozone	Ventex®	10	N/A -
265028	FFP3 NR D + gas** † TLV (activated carbon)	Ventex®	10	N/A -

### Smart Pocket Series



- Folded masks in individual packaging
- Comfortable nose seal
- Loop strap with clip

Cat. No.	Level of protection	Valve	Units/box	Price/box
265094A	FFP2 NR D	Ventex®	10	N/A -
265030	FFP3 NR D	Ventex®	10	N/A -

### Smart Solo Series



- Masks with single strap and headpiece
- Quick insertion and removal even with gloves
- Comfortable nose seal

Cat. No.	Level of protection	Valve	Units/box	Price/box
265024	FFP1 NR D	Ventex®	20	N/A -
265027	FFP2 NR D	Ventex®	20	N/A -

### Air Series



- FFP masks with AirWave folded filter technology: 260% more filter surface and significantly reduced breathing resistance
- High filtration capacity and longer usage time
- Comfortable nose seal, Loop strap with clip

Cat. No. size S	Cat. No. size M/L	Level of protection	Valve	Units/box	Price/box
265008	265031	FFP2 NR D	Without	10	N/A -
265009	265007	FFP2 NR D	Ventex®	10	N/A -
265033	265032	FFP3 NR D	Without	10	N/A -
265011	265010	FFP3 NR D	Ventex®	10	N/A -

### Air Plus Series



- Reusable FFP masks with AirWave folded filter technology: 260% more filter surface and significantly reduced breathing resistance
- High filtration capacity and longer usage time
- Complete washable seal made of hypoallergenic TPE, sliding tie with closing clip

Cat. No.	Level of protection	Valve	Units/box	Price/box
265034	FFP2 R D	Ventex®	5	N/A -
265035	FFP3 R D	Ventex®	5	N/A -
265096A	FFP2 R D	Provalve® (reduction of exhalation condensation)	5	N/A -
265097A	FFP3 R D	Provalve® (reduction of exhalation condensation)	5	N/A -

### Accessory

Cat. No.	Description	Price
265130	FFPak Storage Case for Shell Mask	N/A -



## MOLDEX masks with fixed cartridges

### MOLDEX Compact Mask Integrated Filter Half Masks

- Ultra-compact, ready-to-use, maintenance-free half-mask
- Wide field of vision, total freedom of movement
- FlexFit technology: adjusts to any face shape
- Folded filters for low breathing resistance and long durability
- Lightweight and comfortable (between 210 and 270 g per mask)
- Complies with EN 405:2001

Cat. No.	Protection Level	Units/box	Price/box
265038	FFA1 P2 R D	1	N/A -
265040	FFA2 P3 R D	1	N/A -
265042	FFA1B1E1K1 P3 R D	1	N/A -
265041	FFA1B1E1 P3 R D	1	N/A -
265098	Pre-filters for Compact Mask	10	N/A -



## MOLDEX masks with removable cartridges

### MOLDEX Half Masks Series 7000

- Reusable half-masks to be completed with side filters
- Easy cleaning and maintenance without tools
- DropDown option to wear the mask around the neck during breaks
- With EasyLock® filter system: easy to attach
- Complies with EN 140:1998

Description	Size S	Size M	Size L	Price
<b>Mask body in TPE:</b> soft and comfortable to wear; suitable for most uses	265055	265056	265057	N/A -
<b>Silicone face piece:</b> soft and comfortable to wear even in extreme temperatures	265109A	265110A	265111A	N/A -



### MOLDEX Full Face Masks Series 9000

- Extremely light (360 g) full face mask with panoramic lens
- Easy to place and remove
- Easy maintenance and cleaning without tools
- EasyLock® filter connectors: easy to attach, or EN 148-1
- No adapters or extra parts required
- Mask body in TPE, soft, hypoallergenic
- Complies with EN 136:1998 Classe 2

Description	Size S	Size M	Size L	Price
Masks with EasyLock® filter connectors	265076	265077	265078	N/A -
Masks with filter connectors EN 148-1	265079	265080	265081	N/A -





## Filters for MOLDEX masks

### EasyLock® gas filters for 7000 and 9000 series

Cat. No.	Protection Level	Units/box	Price/box
265122A	A1	10	N/A -
265088	A2	8	N/A -
265123A	ABE1	10	N/A -
265124A	ABEK1	10	N/A -
265126A	A2B2E1	8	N/A -
265127A	AX	8	N/A -
265129A	ABEK2	8	N/A -

### EasyLock® Particle Filters for 7000 and 9000 Series

Cat. No.	Protection Level	Units/box	Price/box
265082	P1 R	20	N/A -
265083	P2 R	20	N/A -
265084	PR R + ozone	12	N/A -
265085	P3 R	12	N/A -
265086	P3 R + ozone	12	N/A -

### Mask + filter packs

➤ Ready to use box with mask (size M) and filters

Cat. No.	Mask series	Protection Level	Price
265113A	7000	A1 P2 R	N/A -
265058	7000	A2 P3 R	N/A -
265059	7000	A1B1E1K1 P3 R	N/A -
265090	9000	A1B1E1K1 P3 R	N/A -

### EasyLock® combined gas and dust filters

Cat. No.	Protection Level	Units/box	Price/box
265087	A1 P2 R	8	N/A -
265089	A2 P3 R	6	N/A -
265125A	ABEK1 P3 R	6	N/A -
265128A	ABEK1Hg P3 R	6	N/A -

TIP



### Gaseous and vaporous pollutants

Type	Protection factor	Category of pollutants	Examples
A1	50 x TLV or 1000 ppm	Organic gases and vapours with boiling points >65 °C	Paint solvents, adhesives, pesticides..
A2	50 x TLV or 5000 ppm	Organic gases and vapours with boiling points >65 °C; same as A1 but with higher concentrations	Paint solvents, adhesives, pesticides..
ABE1	50 x TLV or 1000 ppm	Organic gases and vapours with boiling points >65 °C (A1) + inorganic gases and vapours (B1) + acid gases (E1)	B1: chlorine, bromine, hydrogen sulfide, cyanogen chloride; E1: nitric acid, sulfur dioxide, hydrochloric acid
ABEK1	50 x TLV or 1000 ppm	Combined filter A1, B1, E1, K1 (Ammonia and derivatives)	

### Particulate pollutants

Type	Features	Protection Level	Specifications
P1 R* D**	4 x TLV	Dusts, fumes, mists with water or oil as liquid phase; aerosols	Non-toxic dusts, cellulose, coal, lime, pollen, sugar
P2 R D	12 x TLV	Fine and toxic dusts, mists with water or oil as liquid phase, aerosols, group 2 biological agents	Same as FFP1 but in higher concentrations; toxic dusts, aluminium oxide, bauxite, borax, brick dust, cement, gypsum, calcium oxide, concrete dust, granite, lead dusts and fumes, mould, softwood dusts, zinc oxide smoke
P3 R D	48 x TLV	Hazardous and carcinogenic dusts, mists with water or oil as liquid phase, aerosols; Group 2 and 3 biological agents; CMR substances.	Same as FFP2 but in higher concentrations; carcinogens, ceramic fibres, brake dust, chromates, chromium, cobalt, nickel, hardwood dust, micro-organisms, radioactive and biochemically active aerosols, enzymes, viruses
ABEK1	50 x TLV or 1000 ppm	combined filter A1, B1, E1, K1 (Ammonia and derivatives)	

\* R: reusable \*\* D: tested for dolomite dust clogging - source: Moldex

### 3M C100 series Dust Shell Mask



- Disposable masks
- Synthetic elastic
- Adjustable nose bridge
- Light
- Crush resistant
- Version with or without valve

Cat. No.	Description	Units/box	Price/box
950274	FFP1 NR D Mask	20	N/A -
950276	FFP1 NR D mask with valve	10	N/A -
950275	FFP2 NR D Mask	20	N/A -
950277	FFP2 NR D mask with valve	10	N/A -

## VFlex folding dust masks

- Complies with EN 149:2001 + A1:2009
- V-shaped masks: comfortable to wear, easy to breathe and communicate
- Latex-free elastics
- Flat storage: space saving
- Aluminium nose bridge
- Clear field of view

Cat. No.	Protection	Units/box	Price/box
955478	FFP1 NR D	25 x 40	N/A -
955479	FFP1 NR D with valve	15 x 20	N/A -
955480	FFP2 NR D	50 x 8	N/A -
955480A	FFP2 NR D	50	N/A -
955481	FFP2 NR D with valve	15 x 20	N/A -
955481A	FFP2 NR D with valve	15	N/A -
955482	FFP3 NR D with valve	15 x 20	N/A -
955482A	FFP3 NR D with valve	15	N/A -



## Dust masks - 8300 series

- Soft foam face seal allows adaptability to most faces
- Cool-flow valve increases comfort and facilitates the release of warm, moist air from the mask
- Hypoallergenic, completely waterproof once on the skin
- Complies with the European standard EN 149:2001
- Meets the essential safety requirements of the European Directive 89/686 (articles 10 and 11B), CE marking

Cat. No.	Description	Price 10 units
955386	FFP2 NR D Mask	N/A -
955387	FFP2 NR D mask with Coolflow valve	N/A -
950105	FFP3 R D mask with Coolflow valve and seal	N/A -



## 3M Aura 9300+ series 3-panel flat-fold masks

- Complies with EN 149:2001+A1:2009
- Disposable, flat-fold, lower breathing resistance
- Embossed top panel that is designed to help reduce the fogging of eyewear from warm
- Innovative chin tab designed for ease of positioning
- 3M cool flow valve allows heat and moisture to escape
- Nose Foam, ultra soft inner fabric
- Individual packaging

Cat. No.	Description	Units/box	Price/box
950017	FFP1 NR D Mask	20	N/A -
950018	FFP1 NR D mask with valve	10	N/A -
950019	FFP2 NR D Mask	20	N/A -
95006B	FFP2 NR D mask with valve	10	N/A -
950106	FFP3 NR D Mask	20	N/A -
950007	FFP3 NR D mask with valve	40	N/A -
950007B	FFP3 NR D mask with valve	10	N/A -



## 3M C300 Series Foldable Masks

- Complies with EN 149:2001 + A1:2009
- Disposable, flat fold, with built-in noseclip
- Cool Flow Valve: allows heat and moisture to escape
- In an individual bag

Cat. No.	Description	Units/box	Price/box
955491	C310 FFP1 NR D Mask	20	N/A -
955492	C312 FFP1 NR D Mask with Cool Flow Valve	10	N/A -
955493	C320 FFP2 NR D Mask	20	N/A -



## 3M Premium Shell Dust Mask 8825+ and 8835+



- Complies with EN 149:2001 + A1:2009
- Metal-free and PVC-free
- TPE seal: evenly distributed pressure on the face, less fogging
- Colour coded elastics: blue for FFP2 and red for FFP3

Cat. No.	Description	Units/box	Price/box
950279	8825+ FFP2 Mask	5	N/A -
950005B	8835+ FFP3 Mask	5	N/A -

## 3M masks against dust and odours from acid gases or organic vapours

- Combined protection against dust and harmful odours from non-volatile liquids thanks to the activated carbon layer
- Complies with EN 149:2001 + A1:2009

### Anti-dust and acid gas odours



Cat. No.	Description	Units/box	Price/box
955370	FFP2 NR D mask with valve	10	N/A -

- Polyester/polypropylene/carbon filter
- Latex-free
- Shell shape with nose bridge, low breathing resistance

### Anti-dust and odour nuisance from organic vapours



Cat. No.	Description	Units/box	Price/box
955313A	FFP1 NR D Mask	20	N/A -
955371	FFP1 NR D Mask with valve	10	N/A -
955372	FFP2 NR D Mask with valve	10	N/A -

## 3M Integrated Filter Half Masks - 4000+ Series



- Reusable, maintenance-free half-masks
- Lightweight and balanced design
- One-piece design with integrated filters
- Easy and secure fitting: adjustable harness, easy to tighten straps
- Large, double inhalation valves
- Low-profile design allows for other protective equipment to be worn
- New generation: better display of the protection level, reduced breathing resistance

Cat. No.	Class	Description	Units/box	Price/box
955495	FFA1P2 RD	Mask 4251+ - organic vapours* and particles	1	N/A -
955496	FFA2P3 RD	Mask 4255+ - organic vapours* and particles	1	N/A -
955497	FFABE1P3 RD	Mask 4277+ - organic*/inorganic vapours, acid gases, particles	1	N/A -
955498	FFABEK1P3 RD	Mask 4279+ - organic*/inorganic vapours, acid gases, ammonia, particles	1	N/A -

\* Organic vapours with a boiling point above 65 °C

### Accessories

Cat. No.	Description	Units/box	Price/box
955499	Filter cover for 4000+ series masks	10	N/A -
955541A	Rechargeable Flow Fan 1040 for 4000+ series masks	1	N/A -

## 3M Reusable Half Mask



7500 series



6000 series

- Reusable half-masks to be completed with 2 side filters to be fixed by a simple bayonet system
- For 3M gas and/or particle filters
- Compatible with eye and hearing protection
- Can be used with air supply system, please consult us
- Complies with EN 140

### ► 6000 Series - Classic range

- Economical and very light
- Hypoallergenic elastomer face piece
- Minimum maintenance for maximum comfort and simplicity
- Weight: 82 g

### ► 7500 Series - Premium range

- Premium mask, lightweight and minimizing stress points
- Coolflow exhalation valve: reduces moisture inside the mask
- Silicone face piece, thin nose bridge
- Full maintenance possible
- Weight: 136 g

Size	Small	Medium	Large
6000 series			
Cat. No.	950083	950084	950087
Price	N/A -	N/A -	N/A -
7500 series			
Cat. No.	950078	950009	950080
Price	N/A -	N/A -	N/A -



## 3M Full Face Masks

- Reusable masks to be completed with 2 side filters to be fixed by a simple bayonet system
- For 3M gas and/or particle filters
- Scratch and impact resistant polycarbonate panoramic lens
- Compatible with hearing protection
- Can be used with air supply system, please consult us
- Complies with EN 136

- **6000 Series - Comfort range**
- Fixation by 4-strap harness
- Very lightweight design: 400 g
- Hypoallergenic elastomer face piece
- CoolFlow breathing valve
- **7907S series - Premium range**
- For respiratory protection in difficult tasks (minimum breathing resistance)
- Fixation by 6-strap harness
- Double silicone face seal
- Soundproofing membrane for better communication



Size	Small	Medium	Large
<b>6000 series</b>			
Cat. No.	950090	950008	950091
Price	N/A -	N/A -	N/A -

## 3M half mask and full mask filters



### 2000 series protection against dusts

Cat. No.	FFP	Type of risk	Units/box	Price/box
950010	FFP2	Protection against solid and liquid aerosols up to 10 x TLV with half masks and full face masks	20	N/A -
950011	FFP3	Protection against solid and liquid aerosols Up to 50 x TLV with half masks and 200 x TLV with full face masks	20	N/A -
950094	FFP2	Protection against solid and liquid aerosols up to 10 x TLV with half and full masks + organic vapours* + acid gases odours *	20	N/A -
950095	FFP3	Protection against solid and liquid aerosols Up to 50 x TLV with half masks and 200 x TLV with full face masks + organic vapours* + acid gases odours*	20	N/A -
955435	FFP3	Organic vapour odours* + acid gas odours* + hydrogen fluoride (up to 30 ppm) + particulates	20	N/A -

\* for concentrations below the TLV

### 5000 series protection against dusts

Can only be used in combination with 6000 series gas filters.

Cat. No.	FFP	Type of risk	Units/box	Price/box
950092	FFP1 R	Protection against dust up to 4 x TLV with half masks and full face masks	30	N/A -
950093	FFP2 R	Protection against solid and liquid aerosols Up to 10 x TLV with half masks and 200 x TLV with full face masks	20	N/A -
950014	FFP3 R	Protection against solid and liquid aerosols Up to 50 x TLV with half masks and 200 x TLV with full face masks	20	N/A -

### Accessory

Cat. No.	Description	Price 2 units
950015	Ring for 5000 series dust and gas filter combination	N/A -

### Packs

Cat. No.	Class	Masks	Filters	Price
950079	A2P3R	950009	2 filters 950097 + 4 filters 950014 + 2 rings 950015	N/A -
950081	A2P3R	950080	2 filters 950097 + 4 filters 950014 + 2 rings 950015	N/A -
950085	A1P2R	950084	2 filters 950096 + 4 filters 950093 + 2 rings 950015	N/A -
950086	A2P3R	950084	2 filters 950097 + 4 filters 950014 + 2 rings 950015	N/A -

### 6000 Series Protection against gas

Can be combined with 5000 series dust filters.

Cat. No.	Protection	Type of risk	Units/box	Price/box
950096	A1	Organic vapours*	8	N/A -
950097	A2	Organic vapours*	8	N/A -
950098	K1	Ammonia and derivatives	8	N/A -
950099	ABE1	Organic* and inorganic vapours, acid gases	8	N/A -
950013	ABEK1	Organic* and inorganic vapours, acid gases, ammonia and derivatives	8	N/A -
950100	A1 Formol	Organic vapours* and formaldehyde	8	N/A -

\* boiling point > 65 °C

### Combined protection against gas and dust, series 6000

Cat. No.	Protection	Type of risk	Units/box	Price/box
955373	A1P3 R	Organic vapours** and particles	4	N/A -
955375	A2P3 R	Organic vapours** and particles	4	N/A -
955374	ABEK1 P3R + formaldehyde	Organic vapours**, inorganic vapours, acid gases, ammonia and derivatives, formaldehyde up to 10 ppm and particles	4	N/A -
955377	A1E1Hg P3R	Organic vapours**, acid gases, mercury, chlorine and particles	4	N/A -
950102*	AX P3NR	Boiling point organic vapours < 65 °C and particles	4	N/A -
955376*	ABEK2Hg P3R + formaldehyde	Organic vapours**, inorganic vapours, acid gases, ammonia and derivatives, mercury, formaldehyde up to 10 ppm and particles	4	N/A -

\* only to be used with a full face mask \*\* boiling point > 65 °C



## 3M Secure Click Reusable Half Masks HF-800 Series



- Designed to protect in extreme conditions, easy to place and adjust
- Improves communication with the optional acoustic membrane
- Soft silicone face piece for comfort
- Includes a leak check push button
- Weight of the facial part: 182 g
- Use with Secure Click™ filters: fastening system with sound control
- Secure Click™ filters: reduced breathing resistance (dual flow cartridges)

Size	Small	Medium	Large
<b>Standard version</b>			
Cat. No.	955500	955501	955502
Price	N/A -	N/A -	N/A -
<b>Version with acoustic membrane</b>			
Cat. No.	955503	955504	955505
Price	N/A -	N/A -	N/A -

### Secure Click™ dust filters

Cat. No.	Protection	Units/box	Price/box
955511	P2 R	20	N/A -
955512	P2 R + Odours organic vapours and acid gases	20	N/A -
955513	P3 R	20	N/A -
955514	P3 R + Odours organic vapours and acid gases	20	N/A -

### Secure Click™ gas filters

Cat. No.	Protection	Units/box	Price/box
955506	A1	8	N/A -
955507	A2	8	N/A -
955508	ABEK1	8	N/A -

### Pre-filters for Secure Click™ cartridges

Cat. No.	Protection	Units/box	Price/box
955515	P1 R	40	N/A -
955518	P2 R	40	N/A -
955519	P3 R	40	N/A -
955520	Secure Click™ dust and gas suit ring	10	N/A -

### Secure Click™ combined gas and particulate filters

Cat. No.	Protection	Units/box	Price/box
955509	A2P3	8	N/A -
955510	ABEK1 P3	8	N/A -

## 3M Versaflo face and respiratory protection



- Headcovers and Hoods S Series
- For Powered Air Purifying Respirators
- Lightweight headgear with harness
- Combined protection: respiratory, head (face and eyes), neck and shoulder

Eye and face protection according to EN166:2:f:3  
Respiratory protection if used with 3M air source according to EN12941



- Protection against
  - Fine dust and fumes
  - Gases and vapours
  - Gas-particle mixtures for powered air purifying respirators
- Improved comfort
  - Slightly curved shield to reduce glare
  - Limited whistling
  - Limitation of fogging
  - Adjustable head circumference
  - Adjustable airflow direction outside the hood

	Headgear with harness		Hood with harness		Hood with harness chemical resistance	
Size	S/M	M/L	S/M	M/L	S/M	M/L
Cat. No.	955331	955327	955342	955343	955323	955283
Price	N/A -	N/A -	N/A -	N/A -	N/A -	N/A -

### Powered air purifying respiratory system: VERSAFLO TR-600 gas vapour protection kit



- Air purification system worn on the belt
- Assisted ventilation for protection against particles, odours, gases and vapours according to EN60529 IP54
- Adjustable air flow rate
- Lightweight lithium battery
- Kit Contents:
  - Versaflo TR-602E Filter Unit
  - A2P filter and pre-filter (x 10)
  - Filter cover
  - 2 anti-sparkle
  - High capacity battery
  - Smart charger
  - Charging stand
  - BT-30 breathing tube
  - Decontamination belt

Cat. No.	Description	Price
955344	VERSAFLO TR-600 Gas vapour protection kit	N/A -



**ASSISTED VENTILATION:**  
Many configurations available: consult us

## JACKSON SAFETY\* protective eyewear

Elegant and comfortable protective glasses for safety and increased productivity.

- Complies with EN 166 1F(2002)
- Impact resistance at 45m/s in accordance with EN 166:2002 level 1F
- Thin, lightweight and wraparound design for added protection
- Eyewear design to suit all users
- Excellent optical quality, EN 166:2002 class 1
- Proven 99.9% UVA/UVB protection in accordance with EN 166:2002
- CE marking



Model	V50 Calico	V30 Nemesis	V20 Purity	V10 Unispec
• Impact-resistant polycarbonate lens	X	X	X	X
• Lightweight wraparound design	X	X	X	X
• 99.9% UVA/UVB protection	X	X	X	X
• Lens available	3	4	4	3
• Flexible temples with non-slip rubber covers	X	X	X	-
• Characteristics of the nasal bridge	Adjustable	Reinforced	Reinforced	-
• Adjustable temples to adjust the viewing angle	X	X	X	-
• Cushioned brow bar for additional comfort and ventilation	X	X	-	-
• Overglasses available for visitors	-	-	-	X
<b>Clear anti-fog lens (A)</b> Maximum light diffusion, for indoor use	<b>040449</b>	<b>040118</b>	<b>040121</b>	<b>040126</b>
<b>Price/ the pair</b>	<b>N/A -</b>	<b>N/A -</b>	<b>N/A -</b>	<b>N/A -</b>
<b>Smoked lens (B)</b> High light conditions, for outdoor use	<b>040450</b>	-	<b>040462</b>	-
<b>Price/ the pair</b>	<b>N/A -</b>	-	<b>N/A -</b>	-

# PROTECTIVE EYEWEAR

## 3M protective overglasses



- Side protection integrated into the screen
- Specially designed to be worn over prescription glasses
- Adjustable temples
- Swivel and anti-slip tips
- Clear polycarbonate screen
- UV filtration (according to EN 170)
- Anti-fog, anti-scratch, anti-static, and anti chemical attack

Cat. No.	Description	Price the pair
950058	Blue PC Glasses	N/A -

## 3M Secure Fit UV Goggles



- Class 1 polycarbonate optics, suitable for prolonged use
- Anti-UV, anti-scratch, anti-fog (\* except Cat. No. 955291)
- Wrap-around shape, providing good protection and an excellent field of vision
- Pressure-distributed temples: high level of comfort and fit
- High contrast yellow/amber version: suitable for low light environments
- Grey, blue versions against glare (EN172:1994)
- Operating temperature: -5 °C to +55 °C, according to EN166:2001
- Complies with UV protection standards (EN170:2002)
- Weight: 18 g (SF200 model) / 19 g (SF400 model)
- SF400 model: adjustable nose bridge and soft insert for maximum comfort and grip

### SecureFit SF200

Lens colour	Colourless*	Colourless	Grey	Yellow
Cat. No.	955291	955290	955292	955293
Price	N/A -	N/A -	N/A -	N/A -

### SecureFit SF400

Lens colour	Colourless	Grey	Yellow	Mirror blue	Indoor/Outdoor mirror finish
Cat. No.	955334	955335	955336	955337	955338
Price	N/A -	N/A -	N/A -	N/A -	N/A -

## Pulsafe Millennia single lens glasses black



- Black frame with a straight temple and a personalized adjustment system.
- Polycarbonate screen
- Perfect vision and side protection
- 100% UV filtration
- Anti-scratch and anti-fog screen
- Impact protection: 45 m/S
- Weight: 32 g
- Supplied with a Flexicord

Cat. No.	Description	Price the pair
039051	Pulsafe Millennia single lens glasses	N/A -

## Economical protection glasses

Fully transparent glasses with panoramic polycarbonate lens.

- Edges acting as side protection
- Also used as overglasses
- Anti-fog ventilation fins
- Non-sterile
- Weight: 46 grs
- Supplied in packs of 10



Cat. No.	Description	Price 10 units
030721	Economical protection glasses	N/A -

## Medimask Eye Protect Glasses

- Wide and anatomical shape
- Excellent eye protection for users
- Special shape of the shield (front and sides) for good protection against splashing liquids or particles
- Adjustable temples (length and inclination) for a more comfortable wearing of the glasses
- Transparent polycarbonate Shield
- Class II personal protective equipment (CE - 0196)
- Blue polyamide frame
- Weight: 35 g
- Optical class (EN 166): 1
- Impact resistance (EN 166): F
- 100 % UV (wavelength > 380 nm)
- Complies with EN 166
- Must not be stored at temperatures above 50 °C



Cat. No.	Description	Price the 5 pairs
161533	Medimask protective glasses	N/A -

## Uvex Pheos glasses



- Bi-spherical lens with Uvex Supravision coating technology
- Very large field of view without frame
- Inner Anti-fog
- Extreme outdoor scratch protection and chemical resistance
- Completely metal-free
- Very light

Cat. No.	Model	Colours	Lens	Price the pair
267003	Standard version	Black / green	PC clear / UV2-1.2	N/A -
267004	Narrow version	White / green	PC clear / UV2-1.2	N/A -

### Accessory

Cat. No.	Description	Price
267005	Cord for glasses	N/A -

## Uvex Skyper Glasses



- In polycarbonate
- Tilt and length adjustable temples
- Protection against mechanical and chemical impacts
- Panoramic screen with wide field of view
- UV filter 2-12, according to EN170
- Uvex supravision HC-AF (extremely scratch resistant on the outside, 100% UV protective, permanent anti-fog on the inside)

Cat. No.	Colours	Lens	Units/ box	Price/ box
828314	Blue	PC clear / UV2-12	5	N/A -



# PROTECTIVE GLASSES

## Uvex Astropec Glasses



- ▶ Blue glasses, clear lens
- ▶ Panoramic screen with side guards
- ▶ No pressure thanks to flexible temples
- ▶ Tilttable temples to fit all faces
- ▶ Scratch resistant, chemical resistant, easy to clean

Cat. No.	Model	Colours	Lens	Price the pair
940114	Glasses	Blue	PC clear / UV 2-1.2	N/A -

## Uvex Super OTG Glasses



- ▶ Hingeless temples with soft, highly flexible tips that fit over any eyewear without pressure
- ▶ Metal-free
- ▶ Scratch resistant, chemical resistant, easy to clean

Cat. No.	Colours	Lens	Price the pair
267006	Navy blue	PC clear / UV2-1.2	N/A -

## Uvex autoclavable Glasses



- ▶ Wide field of view
- ▶ Uvex Supravision CR treatment, anti-fog coating resistant to autoclaving for 10 cycles

Cat. No.	Model	Colours	Lens	Price the pair
267000	Glasses	White-light blue	PC clear / UV 2-1.2	N/A -
267001	Overglasses	White-light blue	PC clear / UV 2-1.2	N/A -

## Bollé Safety protective glasses with temples

- Polycarbonate lens
- Comfortable and lightweight
- Supplied with microfiber cases (and adjustable cord for IRI-s models)
- Filters out 99.9% of UVA/UVB

### ➤ 4 types of eyepieces available:

- Clear: for indoor use, standard anti-fog and anti-scratch treatment
- Smoke: outdoor applications, protection from sunlight
- ESP (Extra Sensory Perception): indoor/outdoor, reduces glare, filters 57% of blue light (LED)
- Twilight: indoor/outdoor, designed for low light conditions, contrast enhancement, double indoor/outdoor anti-fog



Model	Photo	Features	Lens	Marking Lens	Cat. No.	Price the pair
Border (photo: countour, smoked lens)		- PC Lens - 2.2 mm - Curved 8 - PC mount - Nylon + VSE temples - TIPGRIP non-slip temples - Adjustable non-slip nose - 21 g - Anti-static - Mount marking: ☞ EN166 FT ☞	Colourless	2C-1.2 ☞ 1 KN FT ☞	270000	N/A -
			Smoke	5-2.5 ☞ 1 KN FT ☞	270001	N/A -
			ESP	5-1.4 ☞ 1 FT ☞	270002	N/A -
Rush+ (photo: Rush+, clear lens)		- PC Lens - 2.2 mm - Curved 9 - PC mount - Ultra-flexible two-tone temples, co-injected PC + TBR - Advanced Platinum anti-fog/scratch treatment - Non-slip nose - 26 g - Mount marking: ☞ EN166 FT ☞	Colourless*	2C-1.2 ☞ 1 KN FT ☞	270003	N/A -
			Smoke*	5-3.1 ☞ 1 KN FT ☞	270004	N/A -
			Twilight**	5-2 ☞ 1 KN FT ☞	270005	N/A -
IRI-s (photo: IRI-s, Twilight lens)		- PC Lens - 2.2 mm - Curved 10 - PC mount - 1 model - 1 size: ergonomic and swivelling PC + TBR temples - Advanced Platinum anti-fog/scratch treatment - 3-position nosepiece, memory foam - 27 g - Mount marking: ☞ EN166 FT ☞	Colorless***	2C-1.2 ☞ 1 KN FT ☞	270006	N/A -
			Smoke	5-3.1 ☞ 1 KN FT ☞	270007	N/A -
			Twilight	5-2 ☞ 1 KN FT ☞	270008	N/A -

\*Black/red arms \*\*Black/grey arms \*\*\*Integrated reading magnifier

## Uvex Ultrasonic goggles

- No pressure problems thanks to the combination of soft and rigid materials
- Possibility of wearing glasses
- Uvex Supravision CR treatment, anti-fog coating resistant to autoclaving for 10 cycles



Cat. No.	Colours	Lens	Price the pair
267002	White / transparent	PC clear / UV2-1.2	N/A -

## Bollé Safety special "clean room" protective goggles



### Superblast Auto-Clave

Panoramic field of vision, reinforced ventilation: perfect comfort.

- PC Lens - 2.2 mm - Curved 5
- Ventilated TPE frame
- Ultra-comfortable mask
- Overflow spout for liquids
- Corrective glasses and half mask can be worn
- Untreated polycarbonate face
- 103 g
- Adjustable braid
- Autoclavable
- Frame marking: ☞ EN166 BT ☞
- Lens markings: ☞ 1 BT ☞

Cat. No.	Description	Price the pair
270023	Superblast Auto-Clave goggles	N/A -



### Coverall Auto-Clave

Very light, maximum protection and comfort.

- PC Lens - 1.5 mm - Curved 2.5
- Overflow spout for liquids
- Indirect and interchangeable vents
- Ultra-comfortable autoclavable mask
- Corrective glasses can be worn
- Untreated polycarbonate face
- 54 g
- Frame marking: ☞ EN166 3 4 FT ☞
- Lens markings: ☞ 1 FT ☞

Cat. No.	Description	Price the pair
270010	Coverall Auto-Clave goggles	N/A -

# PROTECTIVE GLASSES

## Uvex ultrasonic goggles



- Made of polycarbonate, very light
- No pressure problems thanks to the combination of soft and rigid materials
- Suitable for use with reading glasses
- Anti-fog interior and anti-scratch exterior treatment and chemical resistance

Cat. No.	Colours	Lens	Price
267008	Grey/black	PC clear / UV2-1.2	N/A -

## Uvex ultravision faceguard goggles



- Polycarbonate mask, PVC frame
- Wide field of view
- Peripheral ventilation system
- Suitable for use with reading glasses
- Uvex supravision HC-AF treatment (anti-fog inside 2 times higher than the norm and powerful anti-scratch outside)
- Flip-up face guard
- Allows the wearing of dust masks or half-masks for respirators

Cat. No.	Lens	Price
267009	PC clear / UV2-1.2	N/A -

## Uvex carbonvision goggles



- Made of polycarbonate, very light
- High mechanical protection
- Flexible frame to fit the contours of the face
- Possibility to remove the frame to clean the elements separately
- Permanent anti-fog interior and powerful chemical-resistant exterior, anti-scratch treatment

Cat. No.	Colours	Lens	Price
267007	Black/grey	PC clear / UV2-1.2	N/A -

## Pulsafe V-MAXX Fogban goggles



Goggles with 180° panoramic field of vision without lateral deformation.

- Indirect ventilation system
- Polycarbonate lens
- Anti-fog
- Impact resistant
- Elastic headband with swivel fasteners for increased comfort and optimal positioning
- 100% UV filtration
- Large curvature of the frame allows for the combined use of corrective glasses and half-masks

Cat. No.	Description	Price the pair
039052	V-MAXX Fogban Goggles	N/A -

## 3M Goggles



- 2 versions: indirect ventilation or sealed
- Different areas of application: against liquid drops, coarse particles, gases and fine particles, resistance to molten materials and solid penetration, protection against low and medium energy impacts at extreme temperatures
- Complies with EN 166:2001 and EN 170:1992
- UV protection, anti-fog, anti-scratch (only for PC lenses)

	Ventilated version	Sealed version
Acetate Lens	950016	950062
Price the pair	N/A -	N/A -
PC Lens	950060	950061
Price the pair	N/A -	N/A -

## Dispensers for protective glasses and accessories

### Dispensers for protective equipment

- Transparent acrylic
- Easy access to safety accessories as: shoe covers, masks, mobcaps, safety glasses (10 or 20), earplugs (approx. 200 pairs)
- Marking on the box for identification
- Dimensions W x D x H: 227 x 162 x 156 mm
- To be placed on a bench or fixed to the wall (screws included)

Cat. No.	Marking	Colours	Price
037939	Safety glasses	Blue	N/A -
037941	Earplugs	Green	N/A -
037942	-	Natural	N/A -



086668

### Glasses dispenser

Cat. No.	Description	Price
086668	Acrylic wall-mounted glasses dispenser, 483 x 203 x 102 mm	N/A -

### Face shield

Polycarbonate screen with polyethylene headband.

- Adjustable and comfortable 1.5 mm thick headband holder
- Wrap-around shield protects the front and sides of the face, neck and top of the head
- UV protection between 200 and 360 nm
- Protects against splashes - useful in germicidal procedures, tape or gel reading
- L x W: 295 x 200 mm



Cat. No.	Description	Price
029196	Face shield	N/A -

### UV protective glasses

- CE marked
- Blocks UV below 400 nm



Cat. No.	Description	Price
441181	UV protective glasses	N/A -

### Face shield with visor

Perfectly transparent polycarbonate face shield. The shield is attached to a front visor. Packaging per box: 1 coloured visor with 3 polycarbonate screens.

- The screen can be removed from the visor and replaced with a simple gesture
- Resistant and totally waterproof barrier, ensuring total and perfect protection of the face
- Very light

3 presentations:

- adjustable visor: closes with an adjustable buckle; comfortable, the most convenient;
- visor with cord: closes with a cord, flexible and ideal for long term wear;
- fixed visor: more rigid, it is held around the head on its own; suitable for short-term use (45 minutes).



030701



030703



030702

### Replacement shield

Cat. No.	Description	Price
030704	Replacement PC shields for all visors	N/A -

Visor colour	White	Blue	Pink	Green	Price
Shield with visor	030705	030706	030707	030708	N/A -
Shield with cord	030700	030701	030702	030703	N/A -
Shield with fixed visor	030709	030710	030711	030712	N/A -

### Protective visor

- Adjustable
- Comfort
- Polypropylene headband
- PET Shield 240 µm
- Perfectly transparent
- Compatible with glasses or masks
- Weight: 61 g
- Delivered flat packed, easy to assemble
- For safe working

Headband colours	Black	White	Units/box	Price/box
Cat. No.	540133	540137	10	N/A -





## Large protective screen



- ▶ Transparent polycarbonate
- ▶ Thickness: 4.7 mm
- ▶ Heavy steel base with blue epoxy coating
- ▶ External dimensions of the base  
L x W: 500 x 170 mm
- ▶ Highly impact resistant

Cat. No.	Size (mm)	Weight (kg)	Price
947837	760	8.4	N/A -
947838	910	8.9	N/A -

## Safety Splash Flexible Shield



This shield attaches easily to benchtop shelving or on any magnetic surface.

- ▶ Flexible acetal arm
- ▶ Magnetic base
- ▶ Protection from splashes, sprays, projections
- ▶ Easy to maneuver arm, 355 mm
- ▶ 3 mm thick polycarbonate shield
- ▶ UV protection from 200 to 360 nm
- ▶ W x L: 216 x 280 mm
- ▶ Not autoclavable

Cat. No.	Description	Price
029983	Complete flexible screen	N/A -

## Uvex Earplugs

Advantages of disposable earplugs combined with those of reusable.

- ▶ Optimal comfort
- ▶ Suitable for short and long term wear
- ▶ Hygienic: no handling before installation
- ▶ Adjustable cord

### Uvex hi-com

- ▶ Hollow earplug: pressure reduction in case of impact or friction
- ▶ Do not block voice frequencies (M), allowing communication
- ▶ Mitigation: SNR 24 dB (H = 28; M = 23; L = 19)

Description	Units/box	Green		Beige	
		Cat. No.	Price/box	Cat. No.	Price/box
Pair of SNR24 earplugs without cord in individual bag	200	267023	N/A -	267027	N/A -
Pair of SNR24 earplugs with cord in individual bag	100	267024	N/A -	267028	N/A -



### Uvex Xact-fit

- ▶ Earplugs with placement aid.
- ▶ Mitigation: SNR 26 dB (H = 28; M = 23; L = 19)

Cat. No.	Description	Units/box	Price/box
267019	Pair of Xact-fit disposable earplugs with reusable cords, individual bag	50	N/A -
267020	Pair of Xact-fit disposable earplugs, 5 pairs per case	250	N/A -
267021	Pair of Xact-fit replacement earplugs	400	N/A -
940160	Xact-band Banded Earplugs	5	N/A -

### Accessories

Cat. No.	Description	Units/box	Price/box
267022	Dispenser	1	N/A -
267026	Dispenser refill	300	N/A -

## Spark Plugs® Disposable earplugs



- ▶ Comfortable, soft PU foam, easy to insert in the ear
- ▶ Suitable for long periods of noise exposure
- ▶ Tapered shape
- ▶ Packaged in pairs
- ▶ Tested and certified in accordance with the EN 352-2:2002

SNR* (dB)	Attenuation level* (dB)			Units/box	Cat. No.	Price/box
	H	M	L			
35	34	32	31	200 pairs	265000	N/A -
				1 pair	265000B	N/A -

## Mellows® Disposable earplugs



- ▶ Effectively protect against lower noise levels, but designed not to isolate the user
- ▶ Packaged in pairs
- ▶ Tested and certified in accordance with the EN 352-2:2002

SNR* (dB)	Attenuation level* (dB)			Units/box	Cat. No.	Price/box
	H	M	L			
22	26	18	12	200 pairs	265001	N/A -
				1 pair	265001B	N/A -

## Contours Earplugs

SNR (dB)	Attenuation level (dB)		
	H	M	L
35	34	33	28

Cat. No.	Model	Pairs/box	Price/box
265015	Contours	200	N/A -
265016	SMALL Contours	200	N/A -



- Disposable, PU foam
- Optimised shape, available in 2 sizes
- Packaged in pairs, in bags
- Tested and certified according to EN352-2:2002

## Spark Plugs detect

- For the food industry
- Fully detectable
- Made of soft PU foam
- Tested and certified in accordance with the EN 352-2:2002
- Supplied with detectable cord
- SNR value: 32 db

Cat. No.	Description	Units/box	Price/box
265068	Detectable earplug	200	N/A -



## Rockets® Full detect earplug

- For the food industry
- Washable and reusable
- Fully detectable
- Made of soft, hypoallergenic TPE
- Air pocket at the end
- Solid pin for easy insertion and removal of the cap
- Delivered in a storage box
- Tested and certified in accordance with the EN 352-2:2002
- Supplied with detectable cord
- SNR value: 27 db

Cat. No.	Description	Units/box	Price/box
265053	Detectable earplug	50	N/A -



## WaveBand 2K® Banded Earplugs

- Anatomically designed banded ear plugs: worn under the chin to allow freedom of movement without contact sounds or uncomfortable rubbing
- Effective and comfortable all-day hearing protection (ultra-lightweight: 12 g)
- Polyoxymethylene (POM) and thermoplastic elastomer (TPE) headband, PU Banded Earplugs
- Tested and certified in accordance with the EN 352-2:2002
- Additional spare earplugs sold separately

SNR* (dB)	Attenuation level* (dB)			Units/box	Cat. No.	Price/box
	H	M	L			
27	30	23	22	8 earplugs	265002	N/A -
				1 earplug	265002B	N/A -

Cat. No.	Description	Price
265012	Spare earplugs for Waveband banded earplugs	50 units N/A -



## AB clarity C1 Headset



- Dielectric anti noise headset
- Ventilated inner headband and ear pads
- Optimal comfort for extended wearing
- Eliminates harmful noise and allows voice, alarm and other warning signals to pass through
- Adjustable headband
- Weight: 194 g
- Standar: EN352-1

Cat. No.	Description	Price
678310	AB clarity C1 Headset	N/A -

## M1 Foldable Earmuffs



- High quality, comfortable to wear, easy to store (foldable)
- Protects against intermittent noise and sound impacts
- Ideal for those who don't get a good sound seal with plugs
- SoftCoat coating, metallic colour
- Comfortable and robust padded spring-steel headband: 6 adjustment points
- Tested and certified in accordance with the EN 352-1:2002
- Removable foam insert and headset (recommendation: replace twice a year for optimal protection and hygiene)

SNR* (dB)	Attenuation level* (dB)			Cat. No.	Price
	H	M	L		
31	31	29	21	265003	N/A -

Cat. No.	Description	Price
265013	Replacement foam inserts and earpieces kit	N/A -



### SNR (Single Number Rating)

Indicates the sound attenuation value in dB over all audible frequencies provided by the hearing protector in question. It is calculated by measuring the sound level with and without the hearing protection in question.

### High Medium & Low attenuation values:

Indices equivalent to the measures described by the SNR, but more precisely:

- H: average attenuation in a high frequency spectrum ( $\geq 2$  KHz)
- M : average attenuation in a medium frequency spectrum (0.5 to 2 KHz)
- L : average attenuation in a low frequency spectrum ( $< 0.5$  KHz)

## Peltor™ Optime™ 3M Earmuffs



- Modern design, space-saving profile shells
- Large fluid-filled pads: less pressure and more comfort
- Profiled hoop for effective pressure support and protection
- Reduction of humidity and heat due to the internal depth of the shells
- Easily replaceable pads and absorbent foam for better hygiene (every 6 months)
- CE approved
- Materials: PVC arch, acetal with stainless steel rods, ABS shells and polyether pads and foams

Model	Features	Attenuation level* (dB)				Cat. No.	Price
		SNR	H	M	L		
Optime™ I	Offers lightweight protection with a high degree of flexibility and comfort for the user Designed for moderately noisy environments	27	32	25	15	950053	N/A -
Optime™ II	Designed for noisy environments (it primarily attenuates very low frequencies) Provides a moderate to high level of attenuation	31	34	29	20	950054	N/A -
Optime™ III	High quality hearing protection designed for use in extremely noisy environments Double shell technology minimises internal resonance, maximum high frequency attenuation. An acoustic connection between the interior and exterior volumes also attenuates low frequencies	35	40	32	23	955297	N/A -



### Hygiene kits - Replacement pads and foams

- Change twice a year to maintain the best level of protection, hygiene and comfort
- One pair of pads and foams per kit

For model	Optime™ I	Optime™ II	Optime™ III
Cat. No.	955298	955299	955300
Price	N/A -	N/A -	N/A -



## Colourful clip-on mob caps

► Made of non-woven polypropylene ► Packaged in boxes of 250 units

Colour	Size 48 cm		Size 53 cm		Size 58 cm	
	Cat. No.	Price 250 units	Cat. No.	Price 250 units	Cat. No.	Price 250 units
White	683500B	N/A -	683505B	N/A -	-	-
Blue	683501	N/A -	683506B	N/A -	-	-
Red	683503	N/A -	683508	N/A -	683513	N/A -
Yellow	683504	N/A -	683509	N/A -	683514B*	N/A -

\* Packed per 500 (price per 500)



## Mob cap clip and net



Mob cap clip in non-woven polypropylene. Blue or white.

Cat. No.	Description	Units/box	Price/box
030617B	Mob cap clip, blue - 14 g/m <sup>2</sup>	100	N/A -
475053	Mob cap clip, blue - 10 g/m <sup>2</sup>	100	N/A -
475052	Mob cap clip, white - 10 g/m <sup>2</sup>	100	N/A -

## Round Mob cap

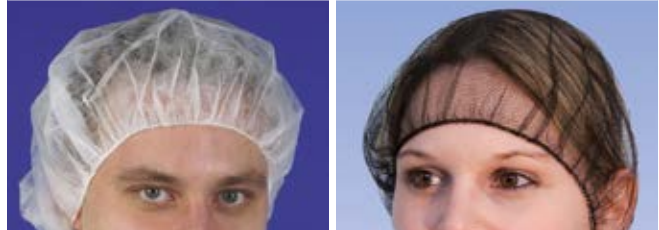

Round Mob cap in non-woven polypropylene. Colours white, blue, black.

Cat. No.	Description	Units/box	Price/box
030615	Round Mob cap, white - 16 g/m <sup>2</sup>	100	N/A -
030616	Round Mob cap, blue - 16 g/m <sup>2</sup>	100	N/A -
475044*	Round Round Mob cap, black - 16 g/m <sup>2</sup>	1000	N/A -

\* in nylon

## ENDOpoteclab disposable Mob caps

► Non-woven synthetic material 20 g/m<sup>2</sup>

► One size fits all: Ø 300 mm with elastic band

White	Green	Units/box	Price/box
942686	942687	100	N/A -



## Beard protector

► In white non-woven

Cat. No.	Description	Units/box	Price/box
475043	Beard protector	1000	N/A -



## Viscose Universal Cap

► Non-woven, airy, highly stretchable

► Single use, non-sterile

► In viscose and ethylene vinyl acetate copolymer

► Circumference: 57 cm, height: 33 cm

► Weight: 40 g/m<sup>2</sup>

► Thickness: 1.2 mm

Blue	Green	Units/box	Price/box
475184	475185	5 dispenser boxes of 100	N/A -



475184



475185

## Polyethylene sleeve



White sleeves 40 x 20 cm in polyethylene 20 µm.

► White ► Dim. 40 x 20 cm ► Made of polyethylene ► Thickness: 20 µm

Cat. No.	Description	Units/box	Price/box
030663	Polyethylene sleeves	100	N/A -

## Polyethylene protective sleeve



► Waterproof

► Dim.: 220 x 440 mm

► Thickness: 20 µm

► With elastics at both ends

Cat. No.	Colours	Units/bag/	Price/bag
794058	White	100	N/A -
794059	Blue	100	N/A -



## Polyethylene protective sleeves



- ▶ Waterproof and durable
- ▶ Suitable for use in the food industry
- ▶ In pure LDPE
- ▶ L x W: 400 x 200 mm
- ▶ Thickness: 16 µm
- ▶ Elastics diameter: 50 mm

Cat. No.	Colour	Units/bag/	Price/bag
794058B	White	100	N/A -
794059B	Blue	100	N/A -

## TYVEK® 500 Sleeves



- ▶ Stitches on the upper elastic
- ▶ Removable
- ▶ Long.: 46 cm

Cat. No.	Description	Units/box	Price/box
073668	TYVEK® 500 Sleeve - white	200	N/A -

## TYCHEM® 2000C and 6000F sleeves



- ▶ PPE cat. III, type PB[3] partial chemical protection
- ▶ Barrier against infectious agents (EN 14126)
- ▶ Antistatic treatment on the inside (EN 1149-5)
- ▶ Length: 50 cm
- ▶ Sewn and covered seams
- ▶ Substrat en Tyvek® substrate with a polymer coating (Yellow model: 84.6 g/m², grey model: 117.5 g/m²)

Cat. No.	Description	Units/box	Price/box
073660	Tychem® 2000C sleeves - yellow - one size	50	N/A -
073661	Tychem® 6000F sleeves - grey - one size	50	N/A -

## White microfibre protective footwear



- ▶ Safety shoes with microfibre uppers and 200 Joules steel safety end cap
- ▶ Antistatics
- ▶ Dual density PU soles, oil resistant and non-slip (S2), heel cushioning
- ▶ Washable at 40 °C

Size	36	37	38	39	40	41	Price the pair	
Cat. No.	790085	790086	790087	790088	790089	790090	N/A -	
Size	42	43	44	45	46	47	48	Price the pair
Cat. No.	790091	790092	790093	790094	790095	790096	790097	N/A -

## Light clogs



- ▶ Non-slip, very light (103 g for size 37)
- ▶ Complies with EN-347, EN ISO 20347 2008
- ▶ Sizes 35 to 46 (except purple and pink clogs)
- ▶ Easy care (machine washable up to 50 °C or warm soapy water)

Size	White	Blue	Violet	Pink
35	950400	950409	950418	950427
36	950401	950410	950419	950428
37	950402	950411	950420	950429
38	950403	950412	950421	950430
39	950404	950413	950422	950431
40	950405	950414	950423	950432
41	950448	950449	950434	950435
42	950406	950415	950424	-
43	950446	950450	950452	-
44	950447	950451	950453	-
45	950407	950416	-	-
46	950408	950417	-	-
Price the pair	N/A -	N/A -	N/A -	N/A -

### Advantages

- ▶ Side ventilation holes
- ▶ Anatomical insole: prevents heavy legs, plantar and back pain
- ▶ Adjustable rear flange
- ▶ Shock absorber (according to EN20347)
- ▶ Antistatic pad

## Chiroclog clogs

- Made of 100% CFC-free polyurethane
- ISO 20347:2004 Certified
- Anti-slip
- Heel is well supported by the slightly raised back of the hoof
- High comfort, low heel height
- Anatomically shaped insole
- Marked size at the back of the shoe
- Washable at 90 °C
- With ventilation holes
- Colours white, green or blue



Size	35	36	37	38	39	40	41	42	43	44	45	46	47	Price the pair
White	095210	095211	095212	095213	095214	095215	095216	095217	095218	095219	095220	095221	095222	N/A -
Green	095223	095224	095225	095226	095227	095228	095229	095230	095231	095232	095233	095234	095235	N/A -
Blue	095236	095237	095238	095239	095240	095241	095242	095243	095244	095245	095246	095247	095248	N/A -

## Autoclavable antistatic laboratory clogs

- Anti-fatigue, for prolonged standing
- Antistatics, DIN 4843
- Hygienic, does not retain perspiration
- Machine washable at 100 °C water / 105 °C steam / 121 °C dry or sterilizable at 134 °C steam
- Autoclavable according to the usual procedures (each pair of clogs is delivered with a 15 times autoclavable sole - 50 times autoclavable sole optional)
- Anatomically shaped active arch with circulation-stimulating pimples
- Anti-slip coating on the front and sides



Numerous colours available, models also exist in unperforated version: consult us

Size	33-34	34-35	35-36	36-37	37-38	38-39	39-40	40-41	42-43	44-45	Price the pair
Cat. No. orange	950153	950154	950155	950156	950152	950157	950158	950159	950160	950161	N/A -
Cat. No. green	950437	950438	950439	950440	950436	950441	950442	950443	950444	950445	N/A -

## Magnus X-Cel safety shoes

Lightweight safety shoes with carbon toecap and non-slip sole.

- Clog shoes with strap, protected heel
- Made of EVA (Ethylene Vinyl Acetate) polymer, antibacterial, latex-free, good chemical resistance, waterproof
- Ultra-lightweight carbon and fibreglass tip, resistant to 200 J (1500 kg)
- Anti-slip, anti-static, shock absorbing outsole
- Removable insole with foot support
- Machine washable at 30 °C
- Category II / S1 shoes
- Complies with ISO 20345:2011

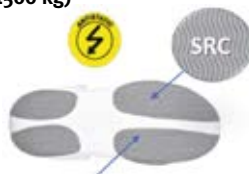

Size	36	37	38	39	40	41	42	43	44	45	46	Price the pair
Cat. No.	943235	943236	943237	943238	943239	943240	943241	943242	943243	943244	943245	N/A -

## Pedisac Overboots

- Made of polyethylene
- Thickness: 60 µm
- Elastic band fastening at the calf
- One size fits all



Cat. No.	Height (mm)	Colours	Units/box	Price/box
131600	48	Transparent	50	N/A -

## Shoe covers



030765



030635



475042



030636



475041

- ▶ Elastic ankle support
- ▶ Two materials:
  - PP: durable non-woven polypropylene, for long-term use, with or without anti-slip sole;
  - PE: polyethylene: simple protection, for short-term use

Cat. No.	Material/colour	Blue anti-slip sole	Units/box	Price/box
030765	PP white	No	100	N/A -
030635	PP white	Yes	400	N/A -
475041	PP white	Yes	1000	N/A -
475042	PP blue	Yes	300	N/A -
030636	PE blue	No	100	N/A -

## ENDOproteclab Disposable overshoes



- ▶ Non-woven synthetic material 20 g/m<sup>2</sup>
- ▶ One size fits all: 400 x 170 mm

Colours	White	Green	Units/box	Price/box
Cat. No.	942688	942689	100	N/A -

## Overshoes and overboots for a protected environment

### Safefect® Isoguard® Overshoes



- ▶ Strong overshoes in PP 80 µm
- ▶ Hydrophobic and non-slip PE sole, lint-free IsoGuard technology
- ▶ One size XL: Length 400mm (sizes 42-45)
- ▶ Prevent contamination due to particle release
- ▶ Tested according to ISO 9973-10: 2003 and EN ISO 11737-1

Cat. No.	Sole	Units/box	Price/box
475155	Blue	400	N/A -

### Waterproof overshoes and overboots in Tyvek® or in PP/PE microporous fleece



475160



475161

- ▶ Tyvek®: high density PE fibres
- ▶ Microporous: PP layer and microporous film
- ▶ Non-linting
- ▶ Air and water vapour permeable
- ▶ Impervious to liquid splashes / fine particles
- ▶ One size XL: length 400 mm (sizes 42-45)

Cat. No.	Material	Anti-slip sole	Units/box	Price/box
475158	Tyvek	Yes	200	N/A -
475160	Microporous	Yes	500	N/A -

## TYVEK® 500 Boot and Shoe Covers



Anti-slip soles

Boot covers

Shoe covers

- ▶ **Boot covers**
  - ▶ In Tyvek®
  - ▶ With upper elastic band
  - ▶ Boot covers with or without anti-slip soles
  - ▶ One size fits all
- ▶ **Shoe covers**
  - ▶ In Tyvek®
  - ▶ Antistatic treatment
  - ▶ With anti-slip soles
  - ▶ Sizes 36 to 46

### Boot covers

Cat. No.	Description	Units/box	Price/box
073610	Boot-cover, H: 48 cm, L: 42 cm	200	N/A -
073611	Anti-slip Boot cover, L: 40 cm	200	N/A -

### Shoe covers

Cat. No.	Description	Units/box	Price/box
073612	Shoe covers, size 36 to 42	200	N/A -
073613	Shoe covers, size 42 to 46	200	N/A -



## TYCHEM® 2000C and 6000F Shoe covers

- PPE cat. III, type PB[3] partial chemical protection
- Barrier against infectious agents (EN 14126)
- Knee-high boot covers
- Partially stitched anti-slip sole (not liquid-proof)
- Antistatic treatment on the inside (EN 1149-5)



Cat. No.	Description	Units/box	Price/box
073658	Boot covers in Tychem C® 2000C - yellow	50	N/A -
073625	Boot covers in Tychem® F 6000F - grey	50	N/A -



## Automatic dispenser for overshoes

- Mechanical system, works without electricity
- Support handle to stabilise the user's position
- Capacity: 220 overshoes
- ABS body
- Dimensions: 74 x 32 x 90 cm
- Weight: 21 kg

Cat. No.	Description	Price
857128	Automatic dispenser for overshoes	N/A -
857129	Anti-slip overshoes for dispenser in PP/PE white/blue (210 units)	N/A -



## Peel-off adhesive sheet mats

Mat with 30 adhesive polyethylene sheets.

- Total thickness: approx. 1.5 mm
- Sheet thickness: 0.04 ± 0.015 mm
- Numbered sheets: indicator of the number remaining
- Environmentally friendly, water-based acrylic adhesive
- RoHs compliant

Cat. No.	Treatment	Dimensions (cm)	Colours	Price 4 units
165034	Strong adhesion	66 x 114	White	N/A -
165035	Antistatic (109 - 1011 Ω)	66 x 114	White	N/A -
165036	Standard	66 x 114	Blue	N/A -
165037	Standard	45 x 114	Blue	N/A -
165038	Standard	66 x 114	White	N/A -
165039	Standard	45 x 114	White	N/A -



## Adhesive mats with bactericide

Mats intercept dust, bacteria and other contaminants.

- Consists of adhesive sheets coated with a bactericide
- Numbered tabs
- Dimensions: 45.7 x 116.8 cm

Cat. No.	Colour	Number of sheets per mat	Price the mat
062040	Blue	30	N/A -
062041	White	30	N/A -
062042	Grey	60	N/A -
062043	White	60	N/A -













## WHAT IS A CHEMICAL PROTECTIVE GLOVE?

The certification of a protective coverall or cloths in a particular type of protection represents its general impermeability against a specific form of exposure (gas, liquid under pressure, spray, dust). Certification does not necessarily mean that the coverall is 100% impervious to this type of exposure, but that the garment meets the **minimum requirements** of the standard.

### ► Chemical protective clothing (cat. III): Types of protection

	<b>Type 1: gas-tight protective clothing.</b> Clothing for protection against liquid and gaseous chemicals, including liquid aerosols and solid particles (EN 943-1:2002 and EN 943-2:2002)
	<b>Type 2: protective clothing that is not gas-tight, but protects against liquid and gaseous chemicals, including liquid aerosols and solid particles</b> (EN 943-1:2002)
	<b>Type 3: protective clothing against liquid chemicals, including exposure to pressurised liquid jets</b> (EN 14605:2005/A1:2009)
	<b>Type 4: protective clothing against liquid chemical sprays (non-pressurised)</b> (EN 14605:2005/A1:2009)
	<b>Type 5: protective clothing against airborne solid particles</b> (EN ISO 13982-1:2004-A1:2010)
	<b>Type 6: limited protective clothing against liquid chemicals, in case of exposure to small quantities of mist or fine spray, or accidental splashes</b> (EN 13034:2005/A1:2009)

### ► Other applicable standards

	<b>Antistatic protective clothing (material performance and construction standards)</b> (EN 1149-5:2008)
	<b>Protection against contamination by radioactive particles: does NOT protect against radiation</b> (EN 1073-2:2002)
	<b>Protection against infectious agents: protection can also be indicated by the letter B (example: Type 3-B)</b> (EN 14126:2003, includes several test methods)

Other standards are applicable, such as protection against heat or flame, degree of visibility.

**Performance classes:** for a given type of protection, the supplier must indicate the performance classes of the materials and seams used. Chemical protective clothing is classified into six categories based on the standardised permeation rate (EN 14325):

Normalized transit time (minutes) or cumulative permeation time	EN Class
> 10	1
> 30	2
> 60	3
> 120	4
> 240	5
> 480	6

Source: DuPont

## 3M Protective Coveralls



### Coverall 4530: breathability and comfort

- PPE Cat. III, type 5-6 (protection against light splashes and hazardous dusts)
- SMS non-woven (55 g/m<sup>2</sup>)
- Elastic hood, waist and ankles, jersey cuffs
- Double zip fastener with adhesive flap
- Blue colour, white triangle on the back
- Antistatic treatment (EN 1149-5)
- Flame resistant (ISO 14116 index 1, EN 533)



### Coverall 4545: light and flexible, reinforced protection

- PPE Cat. III, type 5-6 (protection against light splashes and hazardous dusts)
- Made of soft laminate material (49 g/m<sup>2</sup>)
- Elastic waist and ankles, jersey cuffs
- Double zip fastener with adhesive flap
- White
- Low particle release, suitable for use in cleanrooms
- Protection against infectious agents: type 5-B and 6-B (EN 14126:2003)
- Antistatic treatment (EN 1149-5)
- Protection against radioactive particles class 1 (EN 1073-2:2002)



### Coverall 4565: reinforced protection and lightness

- PPE Cat. III, type 4-5-6 against dust, light chemical splashes, low pressure liquid sprays
- Made of non-microporous laminate material (PP/PE 49 g/m<sup>2</sup>) with low linting, maximum sealing
- Elastic waist and ankles, jersey cuffs
- Double zip fastener with adhesive flap
- White with red covered seams
- Suitable for use in clean rooms
- Protection against infectious agents: type 4-B, 5-B and 6-B (EN 14126:2003)
- Antistatic treatment (EN 1149-5) on both sides
- Protection against radioactive particles class 2 (EN 1073-2:2002)



Model	Size M	Size L	Size XL	Size XXL	Units/box	Price/box
4530	950027	950028	950029	950030	20	N/A -
4545	950256	950257	950258	950259	20	N/A -
4565	950260	950261	950262	950263	20	N/A -

## PROSHIELD® Coveralls

### PROSHIELD® 4 Praktik Coveralls

- PPE Cat. I for protection against minor risks
- In non-woven high density polyethylene 42 g/m<sup>2</sup>, micro-perforated, breathable
- Hooded Coverall with elastics at face, wrists, waist and ankles
- Zip closure
- White
- Anti-static treated lining for comfort



Meaning of symbols page 1170

Size	M	XL	XXL	Units/box	Price/box
Cat. No.	073649A	073651A	073652A	25	N/A -

## Proshield® 20 ex Proshield Basic Coveralls

- PPE Cat. III, type 5, 6 (protection against particles and limited protection against liquids)
- SMS material, light and breathable (air and water vapour permeability)
- Hooded Coverall with elastics at face, wrists, waist and ankles
- Sewn outer seams
- Zipper under flap
- Antistatic treatment on the inside (EN 1149-5)
- Protection against contamination by radioactive particles (EN 1073-2, class 1)
- White or blue
- Packing by the unit



Size	S	M	L	XL	XXL	XXXL	Price 50 units
Blue	073826	073827	073828	073829	073830	073831	N/A -
White	073818	073819	-	-	-	073823	N/A -



## EASYSAFE® Tyvek 200 EasySafe Coveralls

- PPE Cat. III, type 5, 6 (protection against particles and limited protection against liquids)
- Made of non-woven polyethylene, breathable, lightweight, robust
- Hooded Coverall with elastics at face, wrists, waist and ankles
- Yellow stitched seams
- Zipper under flap
- Antistatic treatment on the inside (EN 1149-5)
- Protection against contamination by radioactive particles (EN 1073-2, class 1)
- White
- Packing by the unit



Size	S	M	L	XL	XXL	XXXL	Price 100 units
Cat. No.	073869	073870	073871	073872	073873	073874	N/A -

## TYVEK® 400 Dual Coveralls

- PPE Cat. III, type 5, 6 (protection against particles and limited protection against liquids)
- Front in Tyvek®
- Large breathable SMS panel on the back, protects against particles down to 0.3 µm
- Hooded Coverall with elastics at face, wrists, waist and ankles
- Sewn outer seams
- Zipper under flap, crotch inset
- Antistatic treatment on the inside (EN 1149-5)
- Protection against contamination by radioactive particles (EN 1073-2, class 1)
- White
- Packing by the unit



Size	S	M	L	XL	XXL	XXXL	Units/box	Price/box
Cat. No.	073750	073751	073752	073753	073754	073755	100	N/A -

## TYVEK® 500 Industry Coveralls



- ▶ PPE Cat. III, type 5, 6 (protection against particles and limited protection against liquids)
- ▶ Made of Tyvek®
- ▶ Coveralls with neck, with elastication at wrists, waist and ankles
- ▶ Zipper under flap, crotch inset
- ▶ Sewn internal seams
- ▶ Wearer and product protection, control of particle release and biological contamination
- ▶ Antistatic treatment on the inside (EN 1149-5)
- ▶ Protection against contamination by radioactive particles (EN 1073-2, class 1)
- ▶ Packing by the unit



Size	S	M	L	XL	XXL	Units/ box	Price/ box
Cat. No.	073555	073556	073557	073559	073591	100	N/A -

## TYVEK® 500 Labo Coveralls



- ▶ PPE Cat. III, type 5, 6 (protection against particles and limited protection against liquids)
- ▶ Made of Tyvek®
- ▶ Hooded jumpsuit with tunnelled elastication at wrists, ankles and face. Elasticated waist (glued-in).
- ▶ Integrated shoe covers with non-slip sole
- ▶ Zipper under flap, crotch inset, sewn inner seams
- ▶ Antistatic treatment on both sides (EN 1149-5)
- ▶ Low particle release, Coverall suitable for controlled environments
- ▶ Protection against contamination by radioactive particles (EN 1073-2, class 2)
- ▶ Packing by the unit



Size	S	M	L	XL	XXL	XXXL	Units/ box	Price/ box
Cat. No.	073681	073682	073683	073684	073685	073686	25	N/A -

## TYVEK® 500 Xpert Coveralls



- ▶ PPE Cat. III, type 5-B, 6-B (good protection against particles and liquids)
- ▶ Made of breathable and vapour permeable Tyvek®
- ▶ Hooded Coveralls with tunnelled elastication at wrists, ankles and face. Elasticated waist (glued-in).
- ▶ Zipper under flap, wide inseam
- ▶ Sewn outer seams
- ▶ Antistatic treatment on both sides (EN 1149-5)
- ▶ Protection against contamination by radioactive particles (EN 1073-2, class 2)
- ▶ Protection against infectious agents (EN 14126)
- ▶ White or green (chemical permeation of coloured combinations may differ from the permeation of white Tyvek®, see permeation data)
- ▶ Packing by the unit



Size	Colours	S	M	L	XL	XXL	XXXL	Units/ box	Price/ box
Cat. No.	White	073756	073757	073758	073759	073760	073761	100	N/A -
Cat. No.	Green	-	073570	073571	073572	073573	-	100	N/A -

## TYVEK® 600 plus (ex Classic Plus) Coveralls



- ▶ PPE Cat. III, type 4-B, 5-B, 6-B (protection against particles and liquids)
- ▶ In Tyvek® for comfort and protection
- ▶ Hooded Coveralls with tunnelled elastication at wrists, ankles and face. Elasticated waist (glued-in).
- ▶ Hood compatible with wearing full face respirator
- ▶ Zipper under self-adhesive flap, thumbhole
- ▶ Covered seams
- ▶ Antistatic treatment on both sides (EN 1149-5), low particle release
- ▶ Protection against contamination by radioactive particles (EN 1073-2, class 2)
- ▶ Protection against infectious agents (EN 14126)
- ▶ White
- ▶ Packing by the unit



### TYVEK 600 Plus Coveralls without socks

Size	S	M	L	XL	XXL	XXXL	Units/ box	Price/ box
Cat. No.	073593	073594	073595	073596	073597	073598	100	N/A -

### TYVEK 600 Plus Coveralls with socks

Size	S	M	L	XL	XXL	XXXL	Units/ box	Price/ box
Cat. No.	073599	073600	073601	073602	073603	073604	80	N/A -



## TYCHEM® 2000 C Coveralls

- PPE Cat. III, type 3-B, 4-B, 5-B, 6-B (protection against particles and dangerous liquids, even if concentrated and under pressure)
- In Tychem® 2000 C (Tyvek coated)
- Hooded Coveralls with tunnelled elastication at wrists, ankles and face. Elasticated waist (glued-in).
- Zipper under double adhesive flap, thumbhole
- Covered seams
- Antistatic treatment on the inside (EN 1149-5)
- Protection against contamination by radioactive particles (EN 1073-2, class 1)
- Protection against infectious agents (EN 14126)
- Yellow
- Packing by the unit



### TYCHEM® 2000 C Coveralls without socks

Size	S	M	L	XL	XXL	Units/ box	Price/ box
Cat. No.	073614	073615	073616	073617	073618	25	N/A -

### TYCHEM® 2000 C Coveralls with integrated socks

Size	S	M	L	XL	XXL	XXXL	Units/ box	Price/ box
Cat. No.	073619	073620	073621	073622	073623	073624	20	N/A -

## KLEENGUARD\* A40 (T65XP) Coveralls

- PPE Cat. III, type 5-6 (protection against chemical splashes and particles)
- Made of strong laminated film, for chemical barrier (type 6)
- The fabric retains > 99% of fibres larger than 1 micron (type 5)
- Long zip, hood
- Ankle and wrist elastics
- Internal triple thread overlock seams protect against tearing
- Low particle release, suitable for use in controlled environments
- Antistatic treatment (EN 1149-1)
- Protection against radioactive particles (EN 1073-2 class 1)
- Suitable for handling chemicals and delicate operations in the pharmaceutical industry

Size	S	M	L	XL	XXL	XXXL	Units/ box	Price/ box
Cat. No.	038942	038943	038944	038945	038946	038947	25	N/A -



## HOP'SAFE Hooded Coveralls type 5/6



- ▶ Coverall EPI Cat. III, type 5/6
- ▶ Antistatic treatment (EN1149-5), protection against radioactive particles (EN1073-2)
- ▶ With hood, zip fastener with adhesive flap
- ▶ External seams for comfort
- ▶ Elastic wrist, ankle, hood and waist
- ▶ Air and water vapour permeable membrane made of polypropylene SMS, 55 g/m<sup>2</sup>
- ▶ Good tear and abrasion resistance
- ▶ Individual packaging



Size	S	M	L	XL	XXL	XXXL	Units/box	Price/box
Cat. No.	475237	475238	475239	475240	475241	475242	25	N/A -

## HOP'SAFE Coveralls type 5/6 - asbestos specific



- ▶ Coverall EPI Cat. III, type 5/6
- ▶ Antistatic treatment (EN1149-5), protection against radioactive particles (EN1073-2)
- ▶ With hood, zip fastener with adhesive flap
- ▶ Seams covered with a blue iron-on strip (better protection against the penetration of liquid and solid chemicals)
- ▶ Elastic wrist, ankle, hood and waist
- ▶ Air and water vapour permeable membrane made of polypropylene SMS, 55 g/m<sup>2</sup>
- ▶ Lint-free material (IEST-RP-CC033) resistant to tearing and abrasion
- ▶ Individual packaging



Size	S	M	L	XL	XXL	XXXL	Units/box	Price/box
Cat. No.	475252	475253	475254	475255	475256	475257	25	N/A -

## HOP'SAFE PLUS Coveralls type 5B/6B



- ▶ Coveralls EPI Cat. III, type 5B/6B
- ▶ Antistatic treatment (EN1149-5), protection against radioactive particles (EN1073-2), protection against infectious agents (EN 14126)
- ▶ With hood, zip fastener with adhesive flap
- ▶ Internal taped seams
- ▶ Elasticated wrists, ankles, waist, hood
- ▶ Air and water vapour permeable microporous membrane made of polypropylene SMS with PE coating, 65 g/m<sup>2</sup>
- ▶ Pleasant and flexible, good resistance to tearing and abrasion
- ▶ Individual packaging



### Hooded Coveralls

Size	S	M	L	XL	XXL	XXXL	Units/box	Price/box
Cat. No.	475106	475107	475108	475109	475110	475111	25	N/A -

### Necked Coveralls

Size	S	M	L	XL	XXL	XXXL	Units/box	Price/box
Cat. No.	475246	475247	475248	475249	475250	475251	25	N/A -

## HOP'SAFE EXTRA Coverall

For the protection of the operator and the protection of sensitive products in a protected atmosphere.

- Coverall EPI Cat. III, type 4B, 5B, 6B
- Antistatic treatment (EN1149-5), protection against radioactive particles (EN1073-2), protection against infectious agents (EN 14126)
- With hood, zip fastener with adhesive flap
- Elastic wrist, ankle, hood and waist
- Waterproof/breathable membrane made of polypropylene SMS with PE membrane, 65 g/m<sup>2</sup>
- Lint-free material (IEST-RP-CC033) resistant to tearing and abrasion
- Individual packaging



Size	S	M	L	XL	XXL	Units/box	Price/box
Cat. No.	475261	475262	475263	475264	475265	25	N/A -



## Body Eco Hooded Coveralls

- Non-woven spunbonded polypropylene 38 g/m<sup>2</sup>
- Very soft and opaque material
- White
- Elasticated cuffs and ankles
- Elastic around the waist
- Large lined flap on the zip



Size	M/L	XL	XXL	Units/box	Price/box
Cat. No.	073718	073719	073720	50	N/A -

## Polypropylene Hooded Coverall

- 3-layer non-woven polypropylene 65 g/m<sup>2</sup>
- With hood
- White
- Double seam
- Elastic around the waist, wrists and ankles
- Zip closure
- Individual packaging
- Category III type 5/6



Size	L	XL	XXL	Units/box	Price/box
Cat. No.	475020B	475021B	475022B	50	N/A -

## TYVEK® 500 Lab coats and trousers

- PPE Cat. III type PB[6] - chemical protective clothing partially covering the body
- Made of Tyvek®, which is permeable to air and water vapour while repelling aerosols and watery liquids
- Low particle release, anti-static treatment
- Silicone free
- Protection against infectious agents (EN 14126)
- Antistatic treatment on both sides (EN 1149-1)
- Sewn internal seams

### White lab coat with snap buttons

- Fastened by 5 snap buttons
- With neck
- 3 pockets

Size	M	L	XL	XXL	Units/box	Price/box
Cat. No.	073565	073566	073567	073568	50	N/A -

### White lab coat with zip

- Zip closure
- 2 pockets
- Elastics on the wrists
- With neck

Size	S	M	L	XL	XXL	Units/box	Price/box
Cat. No.	073605	073606	073607	073608	073609	50	N/A -

### Tyvek® white trousers

- Without pocket
- Elastic waistband

Size	M	L	XL	XXL	Units/box	Price/box
Cat. No.	073669	073670	073671	073672	50	N/A -





## TYVEK® IsoClean® range for cleanrooms and controlled environments

### IsoClean® range, bulk



- For use in GMP C/D and ISO 7/8 environments
- Bulk packaging, non-sterile
- PPE Category III, PB[6], protection against infectious agents

#### Tyvek® IsoClean® Lab coats

- Internal taped seams, tunnelled elastication at wrists
- Front snap buttons

Size	S	M	L	XL	XXL	XXXL	Price 30 units
Cat. No.	073922	073923	073924	073925	073926	073927	N/A -

#### Accessories

Cat. No.	Description	Units/ box	Price/ box
073928	Non-slip shoe covers size M (39.5)	50 pairs	N/A -
073929	Non-slip shoe covers size L (48.5)	50 pairs	N/A -
073930	Non-slip boot covers size M (39.5)	50 pairs	N/A -
073931	Non-slip boot covers size L (48.5)	50 pairs	N/A -
073933	Hoods with drawstrings	100	N/A -
073932	Sleeves length 45 cm with elastics	100	N/A -
073936	Mob cap with elastic (diam. 54 cm)	250	N/A -

#### Tyvek® IsoClean® Lab coats with drawstring

- Overlocked seams, knitted cuffs
- Back closure with overlocked ties and tie belt

Cat. No.	Description	Units/ box	Price/ box
073934	Lab coat with ties and knitted cuffs (M)	30	N/A -

### Tyvek® IsoClean® Range, Propre & Stérile



- Cleanroom production, gamma sterilisation, SAL 10<sup>-6</sup> (ISO 11137-1)
- For use in ISO class 5, GMP class A/B environments
- Double packaging (washed and sterilised)
- PPE Category I

#### Tyvek® IsoClean® - Coverall EPI Cat. III

- Sealed seams, sealed neck
- Zip closure
- Wrist and ankle elastics
- Raglan sleeve



Size	S	M	L	XL	XXL	XXXL	Price 25 units
Cat. No.	073839	073840	073841	073842	073843	073844	N/A -

#### Tyvek® IsoClean® Hooded Coverall, with overshoes

- With hood and non-slip overshoes
- Overlocked seams, zipper
- Elasticated: hood, wrists and ankles; thumb loop
- Anti-slip PVC soles

Size	M	L	XL	XXL	XXXL	Price 25 units
Cat. No.	073832B	073833B	073834B	073835B	073836B	N/A -

#### Tyvek® IsoClean® Lab coats

- Sealed seams, elastic cuffs
- Snap buttons

Size	S	M	L	XL	XXL	XXXL	Price 30 units
Cat. No.	073845	073846	073847	073848	073849	073850	N/A -

#### Boot covers

- Elastic and ankle tie
- With non-slip PVC soles

Size	S 37	M 39.5	L 48.5	XL 53	Units/ box	Price/ box
Cat. No.	073851	073852	073853	073854	50 pairs	N/A -

#### Tyvek® IsoClean® Accessories

- Serged Seams

Cat. No.	Description	Units/ box	Price/ box
073856	Hoods with drawstrings	100	N/A -
073858	Hood and mask	100	N/A -
073857	Mob cap with elastic	250	N/A -



## IsoClean® Chemo Gown Lab coat

- Chemotherapy gown
- PPE cat. III, type PB [6-B] (partial protection against chemical splashes, protection against infectious agents EN 14126)
- Non-sterile
- For cleanroom class C/D (ISO 6 to 9)
- Neck model with back closure, hook and loop closure at the neck
- Knitted cuffs, waist ties



XS	S	M	L	XL	XXL	XXXL	Price 30 units
073937	073938	073939	073940	073941	073942	073943	N/A -

## KIMTECH SCIENCE A7 Lab Coats

Partial protection against limited chemical splashes type 6.

- Breathable SMS material, 100% polypropylene, durable, providing a textile-like feel
- Functional cut; lab coat with neck and pockets, back pleat and snap buttons
- Triple-thread overlock stitching for high strength
- Silicone-free and antistatic treatment, in accordance with EN1149-1, suitable for critical environments

- White
- Partial protection, category 3
- Unisex
- Disposable product

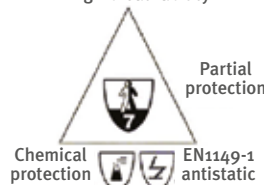
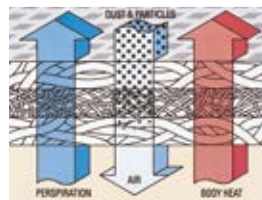

Size	S	M	L	XL	XXL	Units/ box	Price/ box
Cat. No.	038936	038937	038938	038939	038941	15	N/A -

## KIMTECH SCIENCE\* A7 P+ Lab Coats

- PPE Cat. III (directive 89/686/CEE)
- Protection against limited chemical splashes: type 6
- Made of high performance polypropylene
- Silicone-free, abrasion-resistant and low-linting (Helmke cat. II)
- Anti-static, in accordance with EN1149-1: 1995
- Filtration of particles and bacteria: 99 %
- High neck for full chest protection
- Elastic cuffs and thumb loop
- Individually packed in double bags, for ISO 7 cat. C zones

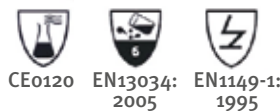

Size	S	M	L	XL	XXL	Units/ box	Price/ box
Cat. No.	039039	039038	039028	039029	039040	15	N/A -

## KIMTECH PURE\* Coverall for cleanrooms

For ISO 7 and 8 environments and grade C and D cleanrooms.

- PPE Category III: Directive 89/686/EC
- Protection against particles: category 5
- Light protection against chemical splashes: category 6

- In white SMS
- Antistatic coating according to EN1149-5:2008
- individually wrapped( non-sterile)
- Applications:
  - Biomedical research, non-sterile pharmaceutical industry, biotechnology

### KIMTECH PURE\* A8: breathable protection against particles

- High neck Coverall, without hood (A)
- Elasticated cuffs, integrated thumb loop (B)
- Filtration of bacteria: 94% according to ASTM F2101 (C)
- Ultra light material (45g/m²) with low linting (Helmke Drum Cat. III)



Size	S	M	L	XL	XXL	XXXL	XXXXL	Units/ box	Price/ box
Cat. No.	041400	041401	041402	041403	041404	041405	041406	25	N/A -



## PRS® Polypropylene Lab Coats



PRS® Lab Coats, white, with classic neck and elastic bands, 22 g/m<sup>2</sup>.

- English neck
- Without pockets
- Elastics on the wrists
- Snap fastener

XL	XXL	Units/box	Price/box
475012	475013	50	N/A -

## ENDOproteclab disposable Lab Coats



- Made of non-woven synthetic material 30 g/m<sup>2</sup>
- Snap closure
- Elasticated handles and lapel neck
- With CE marking

Size	Length (mm)	Green	Price
XL	176 - 190	942932	N/A -

## Body Eco white Lab Coats



- Non-woven spunbonded polypropylene 38 g/m<sup>2</sup>
- Very soft and opaque material
- White
- 4 snap fastener, elasticated cuffs, tailor-made neck, no pockets
- Hook in the neck (for hanging the coat)
- Category 1 - minor risks (not for use in hazardous environments)
- In an individual bag

Size	L	XL	XXL	Units/box	Price/box
Cat. No.	073700	073701	073702	50	N/A -

## Polypropylene Lab Coats with zip closure



- PP hygiene coats, 40 g/m<sup>2</sup>
- Sewn and elasticated at the wrists
- Zip closure
- Inside left pocket
- Available in white and navy blue

Colours	2/M	3/L	4/XL	5/XXL	Price 50 units
White	475351	475352	475353	475354	N/A -
Navy blue	475369	475370	475371	475372	N/A -

## Polypropylene Lab Coat



- Weight: 30 g/m<sup>2</sup>
- Snap buttons
- With pockets

XL	XXL	Units/box	Price/box
475012B	475013B	50	N/A -



## Body Tech Lab Coats

- ▶ Protection against limited splashing of hazardous materials
- ▶ Microporous outer film (waterproof) + soft touch inner non-woven
- ▶ Hook in the neckline to hang the blouse
- ▶ Sewn lab coat
- ▶ Front closure with 4 press studs
- ▶ Without pocket
- ▶ Elasticated cuffs
- ▶ White
- ▶ In an individual bag



Meaning of pictograms: page 1170  
\* size XXL: units/box = 70

Size	M/L	XL	XXL	Units/box*	Price/box
Cat. No.	073703	073705	073706*	80	N/A -

## Visitor Lab Coats

- ▶ Non-woven lab coat, polypropylene
- ▶ Single use
- ▶ Sewn with fitted sleeves and elasticated cuffs
- ▶ Tie neckline and front belt tie



Size	Length (cm)	Green	White	Yellow	Blue	Price/50 units
L	114	711730	711731	711728	711729	N/A -
XL	127	711209	711210	711211	711212	N/A -

## Economic lab coat

- ▶ Waterproof
- ▶ Fastened by Snap buttons
- ▶ Length: 1.10 m
- ▶ Clear polyethylene



Cat. No.	Description	Units/box	Price/box
711934	Economical lab coat in transparent polyethylene	10	N/A -

## "Patient" lab coat

- ▶ Full frontal protection
- ▶ Ribbon closure at neck, belt at waist
- ▶ Length: 1.05 m
- ▶ Made of spunbonded polypropylene non-woven 40 g
- ▶ Elastics on the wrists



Cat. No.	Description	Units/box	Price/box
711935	Non-woven polypropylene "patient" lab coat	10	N/A -

## Visitor kits

Each individually packaged kit contains:

- 1 white clip-on mob cap;
- 1 white lab coat in 20 µm polyethylene with snap buttons;
- 2 blue polyethylene overshoes;
- 1 white paper mask, 1 fold with elastic.

Cat. No.	Description	Price 100 units
030724	Visitor kits	N/A -

## Underwear kit

- ▶ Used for large environments such as airlocks and decontamination showers
- ▶ Made of highly breathable, comfortable and lightweight polypropylene
- ▶ Loose fitting T-shirt for comfort
- ▶ One size fits all, single use

Cat. No.	Description	Price 100 units
475123	Underwear kit: 1 T-shirt, 1 pair of shorts and socks	N/A -

## Visitor kits



Each individually packaged kit contains:

- 1 green 3-ply mask, made of non-woven PP, with ear straps;
- 1 white clip-on mob cap, in non-woven PP 14 g/m<sup>2</sup>;
- 1 white Body Eco lab coat in non-woven 38 g/m<sup>2</sup> (Cat. I).

Cat. No.	The kit contains	Price the 50 kits
999845	1 mask, 1 mob cap, 1 lab coat size L	N/A -
999846	1 mask, 1 mob cap, 1 lab coat XL	N/A -
999847	1 mask, 1 mob cap, 1 lab coat XXL	N/A -

## PE Ecopron disposable aprons



- Composition: polyethylene
- Dimensions (cm): 125 x 75
- Colour: white
- One size fits all

Cat. No.	Description	Units/ bag/	Price/ bag
030798A	PE Ecopron disposable aprons	100	N/A -

## Plastic apron



- With welded eyelets
- Side straps and neck strap
- Industrial quality
- Black
- Dimensions 80 x 100 cm

Cat. No.	Description	Price
670815	Plastic apron	N/A -

## Coverall, lab coat and apron



Cat. No.	Description	Units/ box	Price/ box
Non-woven polypropylene Hooded Coverall. <b>Photo A.</b>			
030638	Coverall, size L	50	N/A -
030639	Coverall, size XXL	50	N/A -
20 µm polyethylene lab coat. Dim. 125 x 145 cm, white. <b>Photo B.</b>			
030637	Polyethylene lab coat	50	N/A -
White 20 µm disposable polyethylene apron. Dimensions: 135 x 76 cm. White <b>Photo C.</b>			
030645	Disposable polyethylene apron	100	N/A -

## TYCHEM® Aprons

- PPE Cat. III type PB[3] (partial body protection)
- In TYCHEM® (TYVEK® coated with polymeric barrier material) offering good protection against chemical permeation to a wide range of inorganic chemicals and biohazards even under pressure
- Bib apron with ties at the back and neck
- One size fits all (covers legs to shins)
- Antistatic treatment on the inside (EN 1149-5)
- Protection against infectious agents (EN 14126)
- Yellow (TYCHEM® C) or grey (TYCHEM® F)



Cat. No.	Description	Units/box	Price/box
073662	TYCHEM® C Apron - yellow	25	N/A -
073663	TYCHEM® F Apron - grey	25	N/A -

## Sterile isolation gowns

- Made of polypropylene
- Hydrophobic non-woven
- One size (L): 118.5 cm
- With one integrated hand towel 30 x 70 cm

Cat. No.	Units/bag	Units/box	Price/box
711703	28	56	N/A -



## Foliadress Protect Basic straight back surgical gown

- High resistance to the passage of liquids and germs
- Blue polypropylene non-woven, 40g/m<sup>2</sup> (SMS), water-repellent, soft and breathable, lint-free
- Two ties in the back
- Jersey with cuffs
- Sterile - medical device class I (TÜV - 0123)
- Single, with 2 hand towels
- In (double) unit packaging: SMS/paper-film blister
- Dual traceability label with barcode (EAN 128)



Cat. No.	Size	Height (mm)	Circumference (cm)	Units/box	Price/box
161531B	L	125	145	18	N/A -
161532B	XL	140	156	18	N/A -

## Sterile single-use surgical gowns

- Made of cellulose and polyester, hydrophobic non-woven
- Crossed back with ties, adjustable Velcro closure at neck
- Jersey with cuffs
- Reinforced version with flap
- With 2 hand towels and crepe sheet
- Flexible and breathable
- Manufacturing process: Spunlace
- Compliant with EN 13795 and AAMI



Cat. No.	Reinforced with PE	Size	Length (cm)	Units/bag	Units/box	Price/box
711722	No	M	121	20	40	N/A -
711717	No	L	121	20	40	N/A -
711718	No	L	131	20	40	N/A -
711726*	No	L	131	18	36	N/A -
711719	No	XL	132	18	36	N/A -
711723	No	XL	145	18	36	N/A -
711724	No	XXL	161	16	32	N/A -
711725	No	XXL	148	18	36	N/A -
711739*	Yes	L	131	16	32	N/A -
711740*	Yes	XL	145	16	32	N/A -

\* With thumbhole

## Anti-acid Lab Coats



- White Lab Coats for men and women in polycotton 195 g/m<sup>2</sup> (65% polyester - 35% cotton)
- Snap closure
- 3 pockets, V-neck
- Long sleeves, tight cuffs: with snap button

Size	S	M	L	XL	XXL	Price
<b>Women's model</b>						
Chest size (cm)	90	98	106	114	122	
Cat. No.	943057	943058	943059	943060	943061	N/A -
<b>Men's model</b>						
Chest size (cm)	88	96	104	112	120	
Cat. No.	943157	943158	943159	943160	943161	N/A -



## Women's acid-proof lab coat



- 100% Trevira polyester 275 g/m<sup>2</sup>
- Tailored neck
- Front closure with hooks under the flap
- Straight cuffs, adjustable hook and loop fastener
- Chest pocket, inside pocket and 2 lower patch pockets with hidden hook flaps

Size	0	1	2	3	4	5	Price
Cat. No.	380069	380070	380071	380072	380073	380074	N/A -

## Mixed medical Lab Coats



- 100% cotton
- 190 g/m<sup>2</sup> white cotton, 185 g/m<sup>2</sup> green cotton
- Side button closure
- Round neck
- Long sleeves, elastic or knitted cuffs
- 3 pockets (1 heart, 2 low)

Elasticated cuffs

Knitted cuff

Colours	Wrist	XS	S	M	L	XL	XXL	Price
White	Elastic	943125	943126	943127	943128	943129	943130	N/A -
White	Knitted	943131	943132	943133	943134	943135	943136	N/A -
Green	Elastic	943119	943120	943121	943122	943123	943124	N/A -
Green	Knitting	943113	943114	943115	943116	943117	943118	N/A -

## Cotton Lab Coats



A



B



C/D



E/F/G



- 100% cotton 190 g/m<sup>2</sup>
- 3 pockets, V-neck, central closure

### Women's lab coat

Model	Closure	XS	S	M	L	XL	XXL	Price
A	Button	943020	943021	943022	943023	943024	943025	N/A -
B	Button	943026	943027	943028	943029	943030	943031	N/A -
C	Pressure	-	943000	943001	943002	943003	943004	N/A -
D	Button	-	943005	943006	943007	943008	943009	N/A -

### Men's lab coat

Model	Closure	S	M	L	XL	XXL	Price
E	Button	943137	943138	943139	943140	943141	N/A -
F	Button	943147	943148	943149	943150	943151	N/A -
G*	Button	943142	943143	943144	943145	943146	N/A -

\* cotton 210 g/m<sup>2</sup>

## Unisex white lab coat, long sleeves with buttons

- > Cotton
- > Buttons
- > Long sleeves



Size	0	1	2	3	4	5	Price
Cat. No.	380019	380020	380022	380024	380026	380028	N/A -

## Cotton lab coat with snaps

- > For women
- > From 36 to 56
- > 100% cotton
- > Snap closure
- > With two pockets and a left chest pocket



Size	36	38-40	42-44	46-48	50-52	54-56	Price
Cat. No.	380000	380001	380003	380005	380007	380009	N/A -

## Cotton Lab Coats

### Men's lab coat

- > Men's lab coat in Sanfor twill 100% cotton
- > Weight: 260 g/m<sup>2</sup>
- > Snap closure
- > One inside pocket
- > Three bottom patch pockets
- > Colour: white

Size	3	4	5	6	Price
Cat. No.	678028	678029	678030	678031	N/A -

### Women's lab coat

- > Women's long lab coat in 100% cotton cretonne
- > Weight: 190 g/m<sup>2</sup>
- > Fastened by buttons
- > Long sleeves
- > Two chest clips
- > Two front pockets and one chest pocket
- > 5 thread design
- > Colour: white

Size	38	40	42	44	46	Price
Cat. No.	678032	678033	678034	678035	678036	N/A -



## ENDOpoteclab Lab Coats

- > Cotton or cotton/polyester blend 240 g/m<sup>2</sup>
- > Snap closure
- > 3 pockets
- > Lapel neck



### Women's Lab coats

Size	S	M	L	XL	Price
100% cotton	942675	942676	942677	942678	N/A -
65% polyester, 35% cotton	942679	942680	942681	942682	N/A -

### Men's Lab coats

Size	S	M	L	XL	Price
100% cotton	942667	942668	942669	942670	N/A -
65% polyester, 35% cotton	942671	942672	942673	942674	N/A -

## Polyester cotton lab coat

- > Women's lab coat
- > Made of polyester/cotton
- > White
- > Snap closure
- > Long sleeves
- > Two chest clips
- > 2 front pockets
- > 1 chest pocket



Size	38	40	42	44	46	48	50	52	Price
Cat. No.	678300	678301	678302	678303	678304	678305	678306	678307	N/A -

## Women's Lab Coats in cotton or polycotton



- 3 pockets, V-neck
- Snap closure
- 100% cotton or polyester - cotton (65% - 35%)
- Elasticated cuffs



Colours	Fabric	S	M	L	XL	XXL	Price
White	Cotton 190 g/m <sup>2</sup>	943032	943033	943034	943035	943036	N/A -
White	Polycotton 150 g/m <sup>2</sup>	943037	943038	943039	943040	943041	N/A -
Navy blue	Polycotton 125 g/m <sup>2</sup>	943047	943048	943049	943050	943051	N/A -

## Men's polycotton lab coat



- 65% polyester 35% cotton
- 3 pockets, V-neck
- 195 g/m<sup>2</sup>
- Snap closure



Size	S	M	L	XL	XXL	Price
Cat. No.	943152	943153	943154	943155	943156	N/A -

## Coloured polyester Lab Coats - cotton



Orange



Green



- Lab coats 65% polyester - 35% cotton

- 3 pockets, V-neck

### Women's model

- Fastened by buttons

- Long sleeves

Chest size (cm)					
S	M	L	XL	XXL	
90	98	106	114	122	

Colours	g/m <sup>2</sup>	S	M	L	XL	XXL	Price
Navy blue	125	943062	943063	943064	943065	943066	N/A -
Blue	125	943067	943068	943069	943070	943071	N/A -
Light blue	125	943072	943073	943074	943075	943076	N/A -
Black	125	943077	943078	943079	943080	943081	N/A -
Orange	115	943082B	943083B	943084B	943085B	943086B	N/A -
Green	115	943087B	943088B	943089B	943090B	943091B	N/A -
Lilac	125	943092	943093	943094	943095	943096	N/A -
Grey	125	943097	943098	943099	943100	943101	N/A -
Burgundy	125	943102	943103	943104	943105	943106	N/A -

### Men's model

- Snap closure

- Long sleeves, elastic cuffs

Chest size (cm)					
S	M	L	XL	XXL	
88	96	104	112	120	

Colours	g/m <sup>2</sup>	S	M	L	XL	XXL	Price
Green	125	943162	943163	943164	943165	943166	N/A -
Azure Blue	125	943167	943168	943169	943170	943171	N/A -
Blue	125	943172	943173	943174	943175	943176	N/A -
Black	195	943177B	943178B	943179B	943180B	943181B	N/A -
Grey	195	943182B	943183B	943184B	943185B	943186B	N/A -
Red	195	943187B	943188B	943189B	943190B	943191B	N/A -
Chocolate	195	943192B	943193B	943194B	943195B	943196B	N/A -
Beige	195	943197B	943198B	943199B	943200B	943201B	N/A -
Burgundy	195	943202B	943203B	943204B	943205B	943206B	N/A -
Navy blue	195	943207B	943208B	943209B	943210B	943211B	N/A -
Dark green	195	943217B	943218B	943219B	943220B	943221B	N/A -



## Stainless steel dispenser for gloves in boxes or bags

- Designed to limit angles and retention zones (protected environment)
- Stainless steel 304
- Dimensions L x H x D (mm) 310 x 175 x 100
- Supplied with screws and dowels
- Optional: set of magnetic fasteners



Cat. No.	Description	Price
022457	Stainless steel dispenser without retention zone	N/A -
022456	Set of 4 magnetic fasteners for dispenser	N/A -

## PPE Dispensers



Cat. No.	Dispenser for	Type	Dim. L x H x D (mm)	Material	Price
022409	Bulked PPE (mob caps, overshoes, overboots, sleeves)	Large model	200 x 410 x 200	Stainless steel 304	N/A -
022410	Bulked PPE (mob caps, overshoes, overboots, sleeves)	Large model	200 x 410 x 200	Blue lacquered steel	N/A -
022411	Bulked PPE (mob caps, overshoes, overboots, sleeves)	Small model	130 x 310 x 130	Stainless steel 304	N/A -
022412	Bulked PPE (mob caps, overshoes, overboots, sleeves)	Small model	130 x 310 x 130	Blue lacquered steel	N/A -
022413	PPE in bags or bundles	Large model: adjustable centre distance from 120 to 300 mm	340 x 110 x 80	Stainless steel 304	N/A -
022414	PPE in bags or bundles	Small model: adjustable centre distance from 60 to 200 mm	250 x 285 x 100	Stainless steel 304	N/A -
022415	Mobcaps	-	130 x 310 x 130	Stainless steel 304	N/A -
022416	Foldable dust masks	-	305 x 250 x 100	Stainless steel 304	N/A -
022417	Surgical masks	-	185 x 105 x 105	Stainless steel 304	N/A -
022418	Masks (with protective flap)	-	185 x 105 x 105	Stainless steel 304	N/A -
022419	Masks	-	80 x 240 x 45	Stainless steel 304	N/A -
022430	Dust Shell Masks	-	300 x 360 x 260	Blue lacquered steel	N/A -
022431	Dust Shell Masks	-	300 x 360 x 260	Stainless steel 304	N/A -
022433	Gloves (1 vertical box)	-	135 x 270 x 93	Stainless steel 304	N/A -
022434	Gloves (2 boxes)	-	276 x 270 x 93	Stainless steel 304	N/A -
022435	Gloves (3 boxes)	-	415 x 270 x 93	Stainless steel 304	N/A -
022436	Bulk gloves (PE)	Lockable	200 x 170 x 50	Stainless steel 304	N/A -
022437	Bulk gloves (PE)	Lockable	200 x 170 x 50	Blue lacquered steel	N/A -
022438	Bulk gloves (PE)	Lockable	250 x 300 x 40	Blue lacquered steel	N/A -
022439	Overshoes*	Automatic	205 x 400 x 120	ABS	N/A -
022440	Overshoes*	Automatic	235 x 430 x 153	Aluminium	N/A -
022441	Visitor kits	For 12 kits	130 x 400 x 110	Stainless steel 304	N/A -
022442	Apron on a roll	-	470 x 130 x 120	Stainless steel 304	N/A -
022443	Lab coats and Coveralls	Size XL (maximum 400 x 280 mm)	420 x 450 x 280	Stainless steel 304	N/A -
022444	Lab coats and Coveralls	Size S (maximum 350 x 250 mm)	350 x 395 x 260	Stainless steel 304	N/A -

\* for overshoes 022445 (100 PE overshoes)

## Magnetic fastening system for wall mounted PPE dispensers

Cat. No.	Description	Price
022455	Set of 3 magnetic fasteners	N/A -
022456	Set of 4 magnetic fasteners	N/A -

## QuickFix Plasters Dispenser Box



### Quickfix Plasters dispensers

- Easy access to plasters
- Delivered charged, refillable with 90 plasters
- Lockable dispensers
- Dispensers Dimensions (L x W x H): 230 x 135 x 32 mm
- Individually wrapped plasters
- Elastic plasters: adjust to movement
- Waterproof dressings: for humid environments
- Detectable dressings: blue with a wire

\* Compatible refills: 060702 y 060703

Description	Content	Cat. No.	Price	Cat. No. refill	Packaging unit	Price /sales unit
Quickfix elastic	2 x 45 elastic and breathable plasters	060701	N/A -	060703	6 x 45	N/A -
Quickfix Waterproof	2 x 45 waterproof and breathable plasters	060700	N/A -	060702	6 x 45	N/A -
Quickfix Elastic and waterproof	45 elastic plasters+ 45 waterproof plasters	060707*	N/A -	060703	6 x 45	N/A -
Quickfix detectable	2 x 45 blue plasters	060708	N/A -	-	-	-
Quickfix long elastic	2 x 30 long elastic plasters	060709	N/A -	-	-	-
Quickfix detectable long	2 x 30 long blue plasters	060710	N/A -	-	-	-
Quick Fix Mini cases	30 elastic plasters	060714	N/A -	-	-	-
Empty Quickfix dispenser	-	060743	N/A -	-	-	-

### Wound care

Description	Contents/box	Cat. No.	Packaging unit	Price / sales unit
Quickclean Wound Cleaner: 130 x 200 mm sterile cleansing wipes for wounds, cuts, small wounds	40 wipes	060715	11 boxes	N/A -
	20 wipes	060716	6 boxes	N/A -
QuickStop Compression plasters: plasters with integrated elastic, sterile, hypoallergenic compression system	2 plasters 17 x 17 cm and 1 plaster 12 x 7.5 cm	060717	6 boxes	N/A -

## ANAPORE surgical tape



Rolls of microporous bandage, to hold dressings in place on sensitive skins and for the frequent renewal of dressings.

- Hypoallergenic
- High skin tolerance
- White non-woven material
- Withdraw painlessly
- Sold in rolls

### Anapore tape

Cat. No.	Roll size (cm)	Number of rolls per box	Price/box
794039	914 X 1.25	24	N/A -
794040	914 X 2.5	12	N/A -
794041	914 X 5	6	N/A -
794043	500 X 1.25	24	N/A -
794044	500 X 2.5	12	N/A -
794045	500 X 5	6	N/A -
794046	500 X 7.5	3	N/A -

## 3M micropore film on roll



- Dermal film
- Hypoallergenic
- Air permeable
- On a roll

Cat. No.	Description	Units/box	Price/box
030236	Roll 2.5 cm x 9.14 m with reel	1	N/A -
030241	Roll 2.5 cm x 9.14 m	12	N/A -
030281	Roll 2.5 cm x 5 m	1	N/A -

## Carded cotton and cotton wool

### Carded cotton

Cat. No.	Description	Packaging	Price
030231	Rolled carded cotton	Plastic bag 1 kg	N/A -
030232	Carded cotton	Plastic bag 500 g	N/A -

### Hydrophile Cotton

Cat. No.	Description	Price
030230	Surgical cotton wool rolled up in a plastic bag 500 g	N/A -
030285	Surgical cotton wool rolled up in a plastic bag 1 kg	N/A -



## Hydrophilic gauze compress

Purified hydrophilic gauze compress. 17 threads per cm<sup>2</sup>.

Cat. No.	L x W folded (mm)	L x W unfolded (mm)	Number of folds	Sterile	Packaging unit	Price / sales unit
030233	50 x 75	90 x 270	8	No	10 bags of 100	N/A -
030234B	75 x 75	210 x 270	8	No	50 bags of 2 x 12	N/A -
030235	100 x 100	380 x 380	16	No	10 bags of 100	N/A -
030233ST	75 x 75	90 x 270	8	Yes	50 bags of 5	N/A -
030235ST2	100 x 100	380 x 380	16	Yes	180 bags of 10	N/A -
030276A	100 x 200	-	4	No	1 bag of 100	N/A -



## Optima Compresses

- Non-woven
- Non-sterile or sterile
- 4 ply
- 30 grs

Cat. No.	Sterile	Dimensions (cm)	Units/bag	Bags/box	Price/box
030743B	No	5 x 5	50	100	N/A -
030744B	No	7.5 x 7.5	50	100	N/A -
030745B	No	10 x 10	50	100	N/A -
030746B	Yes	5 x 5	5	50	N/A -
030747B	Yes	7.5 x 7.5	5	50	N/A -
030748B	Yes	10 x 10	5	50	N/A -



## Zellin Pure wadding swab

Sold by wrapped roll of 500 swabs

Cat. No.	Description	Price
794054	500 swab roll	N/A -



## Pur-Zellin cellulose swab

- Pre-cut cellulose flat swab
- Easy handling by using the Pur-Zellin Box
- Class I medical device
- For local antiseptics before an injection or infusion
- Layering 14 layers of extra-bleached cellulose 18g/m<sup>2</sup>
- Dimensions: 4 x 5 cm
- Absorption capacity approx. 11 g/g, immersion time ≤ 10 seconds
- In rolls of 500 pre-cut swabs, in polyethylene bags

Cat. No.	Description	Units/box	Price/box
161528	Pur-Zellin cellulose swab	1 roll	N/A -
161542	Pur-Zellin Dispenser Box	1	N/A -





## Alcohol swabs



- Swabs impregnated with 70% isopropyl alcohol
- For disinfecting the skin before injections

Cat. No.	Description	Units/box	Price/box
140425A	Alcohol impregnated swab	200	N/A -
140443	Alcohol impregnated wide swab	100	N/A -

## Alcohol swabs



- Non-woven, alcohol impregnated 70% Isopropanol
- Size: medium
- Prepares the skin before an injection

Cat. No.	Description	Price/ the box of 100
030742	Alcoholic swab	N/A -

## Boxes of 48 mixed wipes



- Composition box A: 12 alcohol lotions, 12 drying lotions, 12 calendula lotions, 12 anti-mosquito lotions
- Composition box B: 12 alcohol lotions, 12 drying lotions, 12 calendula lotions, 12 chlorhexidine lotions

Cat. No.	Description	Price
280010	Box of 48 mixed bags A	N/A -
280011	Box of 48 mixed bags B	N/A -

## Chlorhexidine disinfectant



- Broad spectrum disinfectant
- Colourless solution
- 50 ml sprayer

Instructions for use: spray on healthy skin to disinfect then swab the excess.

Cat. No.	Description	Price
853162	Chlorhexidine disinfectant	N/A -

## Diphoterine-based cleaning product



Suitable for face and body washing in case of chemical splashes, also available as an eye wash.

- Instantly neutralizes acids, bases and solvents
- Sterile solution
- Expiry date: 2 years
- Available in version: 200 ml, 100 ml, and eye wash (50 ml)
- Single-use eyewash version, with seal to ensure device integrity

Cat. No.	Contents	Price
941017	50 ml (eye wash version)	N/A -
941018	100 ml	N/A -
941019	200 ml	N/A -

## Eyewash and saline or pH Neutral wall stations

### > Sterile 0.9% sodium chloride saline solution

- > For rinsing and removing foreign bodies, dust, splinters, solvents, oils
- > Rinse until all foreign bodies are removed

Estimated rinsing time (min.)		
Flask volume	Single eyelet	DUO Eyelet
200 ml	2	-
500 ml	5	2
1000 ml	10	5

### Bottles only

Eyelet	Flask volume (ml)	Cat. No. saline solution	Price	Cat. No. pH Neutral	Price
Simple	200	060030B	N/A -	941012B	N/A -
Simple	500	030025B	N/A -	-	-
Simple	1000	060725	N/A -	060728	N/A -
DUO	500	060724	N/A -	060727	N/A -
DUO	1000	060726	N/A -	-	-

### Wall-mounted stations and boxes

- > With saline solution and/or pH Neutralizing Solution
- > The polystyrene boxes are dustproof and impact resistant and can be hung on walls

Cat. No.	Description	Saline solution	pH Neutral	Price
060729	Wall station (wall bracket & pictogram)	1 x 500 ml	-	N/A -
060028	Wall station (stand & pictogram)	2 x 500 ml	-	N/A -
060730	PH Neutral Wall Station	-	1 x 1000 ml	N/A -
060731	Maxi Wall Station	2 x 1000 ml	-	N/A -
060740	DUO wall station	1 x 1000 ml DUO	-	N/A -
941008	Plum Combi Station	1 x 500 ml	1 x 200 ml	N/A -
060741	Plum Combi Station DUO	1 x 1000 ml DUO	1 x 500 ml DUO	N/A -
060732	Wall-mounted box	2 x 500 ml	-	N/A -
060733	DUO box set	2 x 1000 ml DUO	-	N/A -
060735	Plum Combi-Box DUO	1 x 500 ml DUO	1 x 500 ml DUO	N/A -
060736	Plum Combi-Box DUO MAXI	1 x 1000 ml DUO	1 x 500 ml DUO	N/A -
060744	PS empty box for 200 ml to 500 ml bottles	-	-	N/A -

### > pH Neutral: 4.9 % sterile phosphate buffer for neutralisation:

- > For rinse and neutralisation of acid and alkali chemical splashes
- > Rinse with pH Neutral solution for about 2 minutes, then rinse with saline solution

### > One eye flasks:

- > For one eye rinsing at a time

### > DUO flask

- > For simultaneous rinsing of both eyes



DUO bottle



Plum Combi Station DUO

Wall-mounted box

### Quick Rinse eyewash ampoules

- > With saline solution and/or pH Neutralizing Solution
- > The polystyrene boxes are dustproof and impact resistant and can be hung on walls

Cat. No.	Description	Content	Price
060737	Quick Rinse wall dispenser	10 ampoules	N/A -
060738	Quick Rinse refill for dispensers	4 cases x 5 ampoules	N/A -
060739	Quick Rinse Mini cases	5 cases x 4 ampoules	N/A -

### Accessories

Cat. No.	Description	Price
060742	Belt bag for 200 ml bottle (delivered empty)	N/A -
060029	Belt bag with 200 ml saline solution bottle	N/A -

## Portable eyewash bottle

- > 235 ml bottle (isotonic solution)
- > Contains a buffered solution: neutralising effect on acidic and basic splashes
- > Easy to carry, pocket size
- > Phosphate-free
- > Dust protected eyelet
- > Generous rinsing
- > Shelf life: 4.5 years

Cat. No.	Description	Price
039056B	Portable eyewash bottle 235 ml	N/A -



# FIRST AID KITS

## Multi-purpose/multi-activity first aid kit



### Contains everything needed for quick and efficient interventions:

- sterile compresses;
- adhesive dressings;
- splinter forceps;
- bands;
- tape;
- first aid guide.
- disinfectant;
- gloves;
- hydroalcoholic solution;
- scissors;

Cat. No.	Description	Price
941000	ABS case for 1 to 4 people with wall mounting	N/A -
941001	ABS case for 1 to 8 people with wall mounting	N/A -

## First aid kit



First aid box suitable for all structures with up to 15/20 people.

- **Compartmentalised box**
- **In translucent blue polypropylene**
- **With wall support**
- **Case in accordance with the recommendations of Occupational Health**

### Contains:

- survival blanket;
- hemostatic cushion;
- triangular slings;
- mouth-to-mouth mask;
- single-dose eyewash bottles;
- pressure dressings;
- sterile compresses;
- bands;
- disinfecting wipes;
- assorted adhesive dressings;
- tape;
- fingercots, gloves;
- scissors;
- splinter forceps;
- safety pins;
- first aid guide.

Cat. No.	Description	Price
941002	Occupational health first aid kit	N/A -

## Multi-purpose first aid kit, white polypropylene

Set for 4 to 8 people

Set for 1 to 4 people



Contains everything needed for quick and efficient interventions.

Model	Box 1 to 4 people	Box 4 to 8 people
Sterile swabs	5	10
Strips	1 gauze, 1 stretch band	1 gauze, 1 stretch band
Pressure dressings	1 small, 1 large	1 small, 1 large
Adhesive dressings	10	20
Plasters	1 roll 5 x 2 cm	1 roll 5 x 2 cm
Compresses	2 alcoholic, 2 anti-shock, 2 mosquito repellents	3 anti-shock
Gel bags	1 anti-scald, 1 bactericide	3 anti-scald, 3 bactericide
Scissors	1	1
Splinter forceps	1	1
Fastening clip for strips	4	6
Leather fingercots	0	1
Synthetic gloves	1 pair	2 pairs
First aid guide	1	1
Dimensions (cm)	18 x 13 x 6	26 x 20 x 9
Weight (g)	400	700
<b>Cat. No.</b>	<b>941014</b>	<b>941015</b>
<b>Price</b>	<b>N/A -</b>	<b>N/A -</b>

## First aid stations

► Anti-dust wall station

► Transparent polycarbonate front

► Dimensions L x W x H (mm) 430 x 253 x 92 mm



060721



060723

	QuickSafe Basic	QuickSafe Complete	QuickSafe Food Industry	Quicksafe Chemical Industry
Content	- 2 x 500 ml eyewash saline solution - 1 x 200 ml Neutral pH solution - 5 x 20 QuickRinse ampoules - 1 refill of 45 dressings QuickFix Elastic	- 18 gels Quick Cool anti-burn gels - 1 set of QuickStop compresses - 20 cleaning wipes QuickClean wounds - 2 x 500 ml eyewash saline solution - 1 x 200 ml of Neutral pH - 5 QuickRinse ampoules - 1 refill of 45 dressings QuickFix Elastic	- 18 Quick Cool anti-burn gels - 1 set of QuickStop compresses - 20 QuickClean wound cleaning wipes - 2 x 500 ml eyewash saline solution - 1 x 200 ml of Neutral pH - 1 refill of 45 detectable dressings - 1 refill of 30 dressings long detectable	- 1 x 500 ml eyewash saline solution DUO - 1 x 500 ml neutral pH DUO - 1 x 200 ml Neutral pH - 5 QuickRinse eyewash ampoules - 1 refill of 45 dressings QuickFix Elastic
<b>Cat. No.</b>	<b>060719</b>	<b>060720</b>	<b>060721</b>	<b>060722</b>
<b>Price</b>	<b>N/A -</b>	<b>N/A -</b>	<b>N/A -</b>	<b>N/A -</b>

### Empty QuickSafe Station

Cat. No.	Description	Price
060723	Empty QuickSafe Station	N/A -



## Lacquered metal medicine cabinets

- In lacquered metal
- 1 door
- Key lock
- To be completed with the refill kit ASEP KIT PV 10 (10 person cabinet) or PV 8 (8 person cabinet)
- Refills sold separately



Cabinet 941004 sold empty

### Cabinets and refills

	Empty cabinet - 10-person	Empty cabinet - 8-person
Cabinet Dim. (cm)	30 x 45 x 14	32 x 32 x 15
Full weight (kg)	3.6	3.4
Empty weight (kg)	3	3.2
Colour	White	Red
Cat. No.	<b>941004</b>	<b>941003</b>
Price	N/A -	N/A -
	Refill ASEP KIT PV 10	Refill ASEP KIT PV 8
Cat. No.	<b>941016</b>	<b>941005</b>
Price	N/A -	N/A -

### Refill contents

	10-person	8-person
Survival blanket	1	-
Cotton	100 g	-
Sterile swabs	4 x 5	10
Strips	8 gauze, 4 stretch bands, 4 pads	2 gauzes, 2 stretch bands
Pressure dressings	2 small, 2 large	1 small, 1 large
Adhesive dressings	2 x 10	2 x 10
Plasters	1 roll 5 m x 2 cm	1 roll 5 m x 2 cm
Chlorhexidine antiseptic spray	-	50 ml
Compresses	4 alcoholic, 4 anti-shock	3 anti-shock
Gel bags	4 anti-scalds	3 anti-scald, 3 bactericide
Plastic bottles 125 cc	4	-
Scissors	1	1
Splinter forceps	1	1
Safety pins	12	-
Clip for strips	-	6
Leather fingercot	1	1
Synthetic gloves	2 pairs	2 pairs
First aid guide	1	1



Cabinet 941003 sold empty

## Wall-mounted pharmacy cabinets

Specially designed for storing dressings, medicines and other first aid items.

- 10/10 construction
- Epoxy paint RAL 9010
- Standard symbols
- Key lock
- Wall mounting

Cat. No.	H x L x D (mm)	Number of Shelves	Storage Capacity	Weight (kg)	Price
060094	380 x 470 x 205	2	12 l	1	N/A -
060095	580 x 470 x 205	4	19 l	1	N/A -



## Fire blankets

Cat. No.	Description	Price
060151	Fire blanket, dimensions: 1200 x 1200 mm	N/A -
060152	Fire blanket, dimensions: 1800 x 1200 mm	N/A -



## Minigrip bags

### Minigrip bags

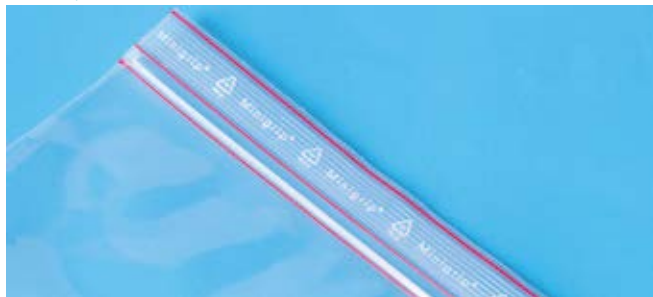

Polyethylene bags with red piping on the zip.

- ▶ **8 mm diameter suspension hole**
- ▶ **Delivered in 1000 units**
- ▶ **Available in simple version, with writing area or with kangaroo pocket**
- ▶ **The writing area is divided into three bands, writing with a biro is possible**
- ▶ **Models with a kangaroo pocket allow the insertion of accompanying documents**

Cat. No.	L x H (mm)	Thick. (µm)	∅ suspension hole	∅ vent hole	Roll of	Pack unit	Price
060523	40 x 60	60	6 mm	Without	100	1000	N/A -
060501	60 x 80	60	8 mm	Without	100	1000	N/A -
060502	80 x 120	60	8 mm	Without	100	1000	N/A -
060705	80 x 120	100	8 mm	Without	50	500	N/A -
060590	85 x 180	60	8 mm	4 mm	50	1000	N/A -
060589	100 x 100	60	8 mm	Without	100	1000	N/A -
060503	100 x 150	60	8 mm	Without	100	1000	N/A -
060704	100 x 150	100	8 mm	Without	50	500	N/A -
060504	120 x 180	60	8 mm	Without	50	1000	N/A -
060599	120 x 180	100	8 mm	Without	50	500	N/A -
060524	140 x 170	60	8 mm	Without	50	1000	N/A -
060585	150 x 180	60	8 mm	Without	50	1000	N/A -
060588	150 x 200	60	8 mm	Without	50	1000	N/A -
060505	160 x 220	60	8 mm	Without	50	1000	N/A -
060598	160 x 220	100	8 mm	Without	50	500	N/A -
060583	180 x 250	60	8 mm	Without	50	1000	N/A -
060506	180 x 350	60	8 mm	Without	50	1000	N/A -
060538	200 x 200 (airport)	60	8 mm	Without	50	1000	N/A -
060586	200 x 250	60	8 mm	4 mm	50	1000	N/A -
060525	200 x 300	60	8 mm	6 mm	50	1000	N/A -
060587	220 x 280	60	8 mm	4 mm	50	1000	N/A -
060526	230 x 300	60	8 mm	6 mm	50	1000	N/A -
060580	230 x 320	60	8 mm	4 mm	50	1000	N/A -
060591	250 x 320	60	8 mm	4 mm	50	1000	N/A -
060596	250 x 320	100	8 mm	4 mm	50	500	N/A -
060584	250 x 350	60	8 mm	Without	50	1000	N/A -
060582	270 x 400	60	8 mm	6 mm	50	1000	N/A -
060521	300 x 400	60	8 mm	6 mm	50	1000	N/A -
060597	300 x 400	100	8 mm	4 mm	50	500	N/A -
060522B	350 x 450	60	8 mm	6 mm	50	500	N/A -

### Minigrip PE antistatic bags



Cat. No.	L x H (mm)	Thick. (µm)	∅ suspension hole	∅ vent hole	Roll of	Price 1000 units
060531	70 x 100	75	Without	Without	50	N/A -
060532	100 x 150	75	Without	Without	50	N/A -
060533	150 x 220	75	Without	Without	50	N/A -
060534	180 x 250	75	Without	Without	50	N/A -
060535	200 x 350	75	Without	Without	50	N/A -
060536*	300 x 400	75	Without	Without	50	N/A -

\* Cat. No. 060536: sold by 500 (price for 500 bags).

### Minigrip PE anti-UV bags



Cat. No.	L x H (mm)	Thick. (µm)	∅ suspension hole	∅ vent hole	Roll of	Price 1000 units
060527	70 x 100	75	Without	Without	50	N/A -
060528	100 x 150	75	Without	Without	50	N/A -
060529	150 x 220	75	Without	Without	50	N/A -
060530	200 x 300	75	Without	Without	50	N/A -

### Double kangaroo pouches



Cat. No.	L x H (mm)	Thick. (µm)	∅ suspension hole	∅ vent hole	Roll of	Price 1000 units
060706	150 x 180 + 160	50	8 mm	Without	50	N/A -
060508	160 x 220 + 160	50	8 mm	Without	50	N/A -
060509	180 x 250 + 170	50	8 mm	Without	50	N/A -

### Bags with writing area



Cat. No.	L x H (mm)	Thick. (µm)	∅ suspension hole	∅ vent hole	Roll of	Price 1000 units
060500	60 x 80	60	8 mm	Without	100	N/A -
060519	80 x 120	60	8 mm	Without	100	N/A -
060514	100 x 150	60	8 mm	Without	100	N/A -
060515	120 x 180	60	8 mm	Without	50	N/A -
060516	160 x 220	60	8 mm	Without	50	N/A -
060517	230 x 320	60	8 mm	6 mm	50	N/A -
060592	150 x 180	60	8 mm	Without	50	N/A -
060593	180 x 250	60	8 mm	Without	50	N/A -
060594	300 x 400	60	8 mm	4 mm	50	N/A -
060595	300 x 450	60	8 mm	4 mm	50	N/A -

## Minigrip bags (continued)

### Topmatic® slider bag

- Polypropylene, transparent and glossy
- Convenient, fast and safe opening and closing with slider

Cat. No.	Dimensions L x D + SDF*(mm)	Thickness (µm)	Units/ box	Price/ box
060550	125 x 90	75	250	N/A -
060551	180 x 110	75	250	N/A -
060552	220 x 115 + SDF 15	75	250	N/A -
060553	200 x 150	75	250	N/A -
060554	250 x 170	75	250	N/A -
060555	240 x 320	75	250	N/A -
060556	265 x 280 + SDF 30	75	250	N/A -
060557	320 x 230	75	250	N/A -
060558	360 x 250	75	250	N/A -
060559	350 x 450 + SDF 30	75	250	N/A -

\* SDF: Bottom gusset



### Doypack® bags

Dimensions L x D + SDF*(mm)	In PET with zip			In aluminium with zip		
	Cat. No.	Units/ box	Price/ box	Cat. No.	Units/ box	Price/ box
85 x 125 + 2 x 25	-	-	-	060568B	500	N/A -
110 x 160 + 2 x 32	060561B	500	N/A -	060569B	500	N/A -
130 x 190 + 2 x 35	060562B	500	N/A -	060570B	500	N/A -
160 x 230 + 2 x 40	060563B	500	N/A -	-	-	-
180 x 255 + 2 x 45	060564B	500	N/A -	060571B	500	N/A -
210 x 270 + 2 x 55	060565B	500	N/A -	060572B	500	N/A -
250 x 300 + 2 x 65	060566B	500	N/A -	060573B	500	N/A -
300 x 330 + 2 x 80	060567B	500	N/A -	-	-	-



## Polyethylene zip lock bags

- Zipper system for fast and secure closure
- Available with a single or double pocket to allow documents to be attached without coming into contact with the samples being transported
- Clear polyethylene
- Thickness of 50 µm
- For the collection and transport of samples

### Single bags

Dimensions W x H (mm)	Without marking area	Price 1000 units	With marking area	Price 1000 units
60 x 80	140212	N/A -	140308	N/A -
60 x 220	140318	N/A -	-	-
70 x 100	140302	N/A -	140309	N/A -
80 x 120	140215	N/A -	140310	N/A -
100 x 150	140211	N/A -	140210	N/A -
120 x 170	140319	N/A -	140317	N/A -
120 x 180	140213	N/A -	140311	N/A -
150 x 180	140303	N/A -	140312	N/A -
150 x 200	140304	N/A -	140313	N/A -
160 x 220	140224	N/A -	140214	N/A -
170 x 240	140305B*	N/A -	140314	N/A -
200 x 250	140316	N/A -	-	-
200 x 300	140217	N/A -	-	-
230 x 320	140306	N/A -	140218	N/A -
350 x 450	140307	N/A -	140315	N/A -

### Double pocket bags

Cat. No.	W x H (mm)	Writing area	Price 1000 units
140221	125 x 170	No	N/A -
140220	125 x 170	Yes	N/A -
140322	150 x 180	No	N/A -
140222	160 x 220	No	N/A -
140223	200 x 300	No	N/A -

Other sizes are available;  
please consult us.

\* Sold by 200 (Price per 2000)



## DUSTCOVER protective bags

For distribution and storage in sterile areas.

- Self-adhesive two-sided protective bag
- Polypropylene film 50 µm
- Excellent mechanical resistance
- Dust protection

Cat. No.	L x W (mm)	Units/ box	Price/ box
095090B	150 x 250	500	N/A -
095091B	200 x 300	1000	N/A -
095092B	300 x 500	800	N/A -
095093B	400 x 550	500	N/A -
095094B	400 x 760	400	N/A -
095095B	600 x 760	200	N/A -

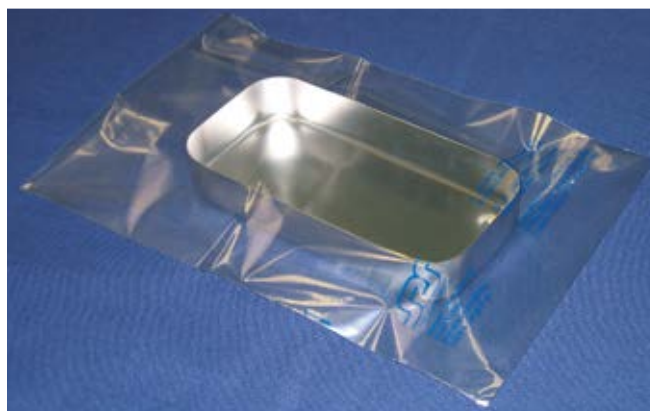



## Whirl-Pak bags



*The universal sample container*

- Low density polyethylene bags, non-autoclavable
- The resins used are FDA and USDA approved for food contact
- Supplied sterilised with ethylene oxide
- Bags closed with metal tabs
- Completely waterproof (ideal for transport)
- The volumes quoted remain approximate
- The capacity of the bags is measured when the tabs are rotated three times around the bag
- Must not be used at temperatures above 82 °C
- Ideal for storing liquids, powders, foodstuffs and various samples



### Bag/rack compatibility

Cat. No.	Compatible racks
052900	-
052901	-
052902	-
052903	D F
052904	D F
052905	D
052906	D
052907	D F
052908	-
052909	-
052910	-
052911	-
052912	-
052913	-
052914	-
052915	-
052916	-
052917	D F
052918	D
052919	D
052920	-
052921	-
052922	-

Cat. No.	W x H (cm)	Volume (ml)	Thickness (µm)	Units/box	Price/box
----------	------------	-------------	----------------	-----------	-----------

### Standard bags

052900	7.5 x 12.5	60	57	500	N/A -
052901	7.5 x 18.5	120	57	500	N/A -
052902	9.5 x 18	210	76	500	N/A -
052903	13 x 19	390	76	500	N/A -
052904	11.5 x 23	540	64	500	N/A -
052905	15 x 23	720	76	500	N/A -
052906	15 x 23	720	102	500	N/A -
052908	12.5 x 30.5	810	76	500	N/A -
052909	12.5 x 38	1080	76	500	N/A -
052910	15 x 38	1260	76	500	N/A -
052911	19 x 38	2070	76	500	N/A -

### Bag with pocket

052907	15 x 25	720	64	500	N/A -
--------	---------	-----	----	-----	-------

### Bags with marking area

052914	6.5 x 12.5	30	57	500	N/A -
052915	7.5 x 12.5	60	57	500	N/A -
052916	7.5 x 18.5	120	57	500	N/A -
052912	7.5 x 18.5	120	64	500	N/A -
052959	9.5 x 18	207	-	500	N/A -
052960	13 x 19	384	-	500	N/A -
052913	11.5 x 23	540	64	500	N/A -
052917	11.5 x 23	540	64	500	N/A -
052918	15 x 23	720	76	500	N/A -
052919	15 x 23	720	102	500	N/A -
052961	12.5 x 30.5	798	-	500	N/A -
052920	19 x 30	1650	102	500	N/A -
052962	19 x 38	2041	-	500	N/A -

### Bags with stable bottom

052922	7.5 x 18.5	120	64	500	N/A -
052921	11.5 x 23	540	76	500	N/A -

### Bags for large samples

052952	25.4 x 38	2721	102	250	N/A -
052953	25.4 x 50.8	3637	102	250	N/A -
052954	38 x 50.8	5441	102	100	N/A -

### Black bag

052958	11 x 23	532	-	500	N/A -
--------	---------	-----	---	-----	-------

### Racks for Whirl Pack bags

Cat. No.	Type	Grid	Dimensions (cm)	Number of boxes	Cases Dimensions (cm)	Price
052926	D	Double	26 x 25.4 x 9	12	8.25 x 6.35	N/A -
052928	F	Double	34 x 27.3 x 10.2	20	6.35 x 6.35	N/A -

## Whirl-Pak Color bags



➤ With marking area and colour code

W x H (cm)	Volume (ml)	Thickness (µm)	Blue	Red	White	Units/box	Price/box
7.5 x 18.5	120	57	052982	052983	052984	500	N/A -
11.5 x 23	540	64	052985	052986	052987	500	N/A -
15 x 23	720	76	052988	052989	052990	500	N/A -
19 x 30	1650	102	052991	052992	052993	500	N/A -

## Whirl-Pak Stand Up bags with stable bottom

- ▶ Made of polyethylene
- ▶ Resistant to many solvents

Cat. No.	W x H (cm)	Volume (ml)	Thickness (µm)	Units/box	Price/box
052922	7.5 x 18	120	0.064	500	N/A -
052957	15 x 23	710	0.076	500	N/A -
052965	12.5 x 38	1065	102	250	N/A -
052964	15 x 38	1242	102	250	N/A -
052963	19 x 38	2041	102	250	N/A -



See Stomachers pages 1404



## Whirl-Pak bags for surface sampling

Sachets with sponge for sampling.

- ▶ Recommended for collecting surface samples
- ▶ Cellulose sponge, bactericide-free, sterile
- ▶ Sponge dimensions: 3.8 x 7.6 x 1.5 cm

See other surface sampling sponges on page 963



Cat. No.	W x H (cm)	Volume (ml)	Thickness (µm)	Units / box	Price/box
052969	11.5 x 23	532	64	100	N/A -
052970	19 x 30	1627	102	100	N/A -
052971*	11.5 x 23	532	64	100	N/A -

\* version with large PE gloves, sterile.

## Moistened sponge in Stomacher bag

For sampling on dry surfaces.

- ▶ Delivered in a zip lock bag size W x H: 18 x 21 cm
- ▶ Dimensions sponge Length 8 cm x width 5.8 cm thickness 3 mm
- ▶ Gamma Irradiated
- ▶ Shelf life 12 months

Cat. No.	Thinner	Vol. (ml)	Standard	Units/box	Price/box
042077	Neutralizer	10	ISO 18593	200	N/A -
042082	Tryptone salt	10	ISO 17604	200	N/A -



## Whirl-Pak bags for mixers

Bags for mixers contain a filter to separate solids and liquids.

### Vertical filter bags



- ▶ 250 µm filter
- ▶ Available with or without metal tab

W x H (mm)	Tot. Vol. (ml)	Working volume (ml)	Thickness (µm)	Units/box	Without tab		With tab	
					Cat. No.	Price/box	Cat. No.	Price/box
190 x 300	1627	400	76	250	952901	N/A -	952908	N/A -
190 x 300	1627	400	76	250	952902*	N/A -	952909*	N/A -
190 x 380	2041	1000	76	250	952903	N/A -	952910	N/A -
254 x 380	2721	1500	76	250	952904	N/A -	952911	N/A -

\* Side seal for easy pouring of liquid.

### Filter bags



- ▶ 330 µm filter
- ▶ With marking area

Cat. No.	W x H (mm)	Total volume (ml)	Working volume (ml)	Thickness (µm)	Units/box	Price/box
052940	95 x 180	210	80	76	250	N/A -
052944	150 x 230	720	400	102	250	N/A -
052946	190 x 300	1650	400	102	250	N/A -
052967	190 x 380	2041	400	102	250	N/A -
052968	254 x 380	2721	1500	102	100	N/A -
952912	380 x 380	4080	2500	102	100	N/A -

## Bags for mixers



### Sterile bags without filter

These sterile (by irradiation) bags are used for sample preparation, transport and storage. Freezing is possible down to -80 °C.

Cat. No.	Volume (ml)	Dimensions (mm)	Pack unit.	Units/box	Price/box
140800	80	100 X 150	25	1500	N/A -
140801	400	180 X 300	25	500	N/A -
140803	3500	380 X 510	25	500	N/A -

### Biohazard sample bags



- Polyethylene bags
- Zip closure
- Available with Biohazard symbol and label
- Double kangaroo pouches

Cat. No.	Biohazard symbol	Dimensions L x W(mm)	Units/box	Price/box
440264	Yes	140 X 150	1000	N/A -
440265	Yes	225 X 150	1000	N/A -
440266	No	104 X 150	1000	N/A -

### BagFilter sterile bags with side filter

These bags are equipped with a lateral filter allowing the collection of the solution to be analysed, free of fibres, either by pipetting with BagPipet and straw pipettes, or by simple pouring. These bags are recommended for the analysis of meat and sausage products.

Cat. No.	Description	Volume (ml)	Dimensions (mm)	Pack unit.	Units/box	Price/box
140807	Filter bag BagFilter®/pouring	400	190 X 300	25	500	N/A -
140802	Filter bag BagFilter®/pipetting	400	190 X 300	25	500	N/A -
150391	Filter bag BagFilter® PCR pull-up/pipetting, small volumes	400	190 X 300	25	500	N/A -
140804	Filter bag BagFilter®/pipetting	3500	380 X 510	10	100	N/A -

### BagPage sterile bags with full surface filter

These bags have a large filtration area which is particularly suitable for the preparation of thick samples, such as cheese. On the BagPage Plus model, a seam on the top of the bag makes it easy to locate the sampling compartment.

Cat. No.	Description	Volume (ml)	Dimensions (mm)	Pack unit.	Units/box	Price/box
140810	Full filter bag BagPage surface	100	100 X 150	25	500	N/A -
140811	Full filter bag BagPage Plus surface	400	190 X 300	25	500	N/A -
140812	Full filter bag BagPage Plus surface	3500	380 X 510	10	100	N/A -

### Multi-purpose bundle of bags



- HDPE, transparent,
- Thickness of 10 µm
- For use from -50 °C to + 120 °C

Cat. No.	Description	Price
039663B	Bundle of bags, dimensions: 230 x 310 mm (5000 units)	N/A -
039664B	Bundle of bags, dimensions: 350 x 500 mm (3000 units)	N/A -

### Biohazard colour sample bags



Bags for the transport of biological samples.

- Made of polyethylene
- Zip closure
- Orange "Biohazard"
- Writing range
- Double pocket
- Dimensions: 16 x 16 cm

Cat. No.	Colours	Units/box	Price/box
390934	Blue	1000	N/A -
390935	Red	1000	N/A -
390936	Orange	1000	N/A -
390937	Pink	1000	N/A -
390938	Violet	1000	N/A -
390607B	Yellow	1000	N/A -
390608B	Green	1000	N/A -
390854B	Transparent	1000	N/A -



## ClearLine® multipurpose bags

- Made of translucent HDPE, thickness 0.45 µm
- For use up to 121 °C

Cat. No.	Dimensions (mm)	Units/box	Price/box
076056	350 x 530	50	N/A -
076057	500 x 930	50	N/A -



**ClearLine®**

## Hermetic bags in SARANEX

- To be used for long term storage, for storage of pathological or valuable samples, forensic samples
- Resistant to most acids, bases and preservatives such as Bouin's liquid
- Liquid and airtight
- Does not absorb or release odours
- Do not alter the composition of the sample taken
- Shock and tear resistant, avoids the use of a double bag
- Double snap closure, easy to open and close

Cat. No.	Dimensions (mm)	Volume (ml)	Price 250 units
062300	150 x 150	540	N/A -
062301	180 x 200	1120	N/A -
062302	230 x 300	3300	N/A -
062303	300 x 300	4900	N/A -



## Zipper bags for sample dish

ZIP bags with sterile identification area.

- Large opening area: 180 mm
- Size W x H = 180 x 250 mm: allows sampling of several hundred grams or even whole portions
- Easy to close with the zip
- Identification area: direct inscription with pen or felt-tip pen (no need for an additional label)
- Resistant to hot food

Cat. No.	Description	Price 1000 units
853081C	ZIP bags with sterile identification area	N/A -



## Absorbent materials for tubes or sheets

- Flexible absorbents with a waterproof PE side

Cat. No.	Description	Units/box	Price/box
800400	Absorbent material for 1 small tube	100	N/A -
800401	Absorbent material for 1 medium tube	100	N/A -
800402	Absorbent material for 2 tubes	100	N/A -
800403	Absorbent material for 3 tubes	100	N/A -
800404	Absorbent material for 4 tubes	100	N/A -
800405	Absorbent material for 6 tubes	100	N/A -
800406	Absorbent material: sheet 90 x 127 mm capacity 15 ml	1000	N/A -
800407	Absorbent material: sheet 200 x 300 mm capacity 150 ml	100	N/A -
800408	Absorbent material: sheet 200 x 300 mm capacity 600 ml	100	N/A -
800409	Absorbent material: 25 g large capacity pad	100	N/A -

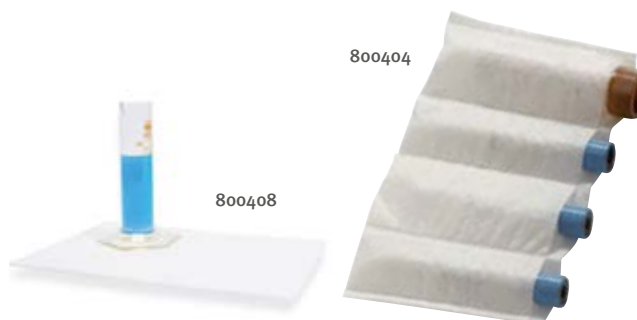

## Diag P650 / UN 3373 bags



800411



800415

- ▶ Adhesive seal bags for the transport of category B biological samples
- ▶ In compliance with the regulations for the transport of samples; marked P650 / UN 3373

### Single-pocket bags

Made of PE, thickness 70 µm.

Cat. No.	Dimensions (mm)	Price 100 units
800410	165 x 170	N/A -
800411	165 x 275	N/A -
800412	255 x 385	N/A -
800413	385 x 580	N/A -
800414	590 x 620	N/A -
800448	575 x 595	N/A -

### IATA standard diag bags

Resistant to 95kPa, air transport compatible.  
Made of PE, 160µm thick, with gusset.  
With side pocket for document transport.

Cat. No.	Dimensions (mm)	Price 100 units
800449	130 x 165 + 110	N/A -
800450	190 x 235 + 130	N/A -
800451	220 x 295 + 130	N/A -

### Double pocket bags

With side pocket for document transport.  
Made of PE, thickness 70 µm.

Cat. No.	Dimensions (mm)	Price 100 units
800415	165 x 265	N/A -
800416	165 x 275	N/A -

## Transport standard adhesive labels



800434



800436

Cat. No.	Description	Dim. (mm)	Colours	Price 100 units
800434	Transport standard label UN 3373	99 x 110	Translucent	N/A -
800435	Standard transport label for dry ice UN 1845	100 x 150	Opaque	N/A -
800436	IATA DGR transport standard label	60 x 100	Opaque	N/A -
800437	Transport standard label THIS WAY UP	60 x 100	Opaque	N/A -

## Nominative Diag bags



800417

- ▶ Made of polyethylene
- ▶ Thickness: 70 µm
- ▶ For the storage and recording of various objects and samples
- ▶ Have a unique identification number on each bag
- ▶ Adhesive closure

Cat. No.	Description	Dim. (mm)	Price
800417	Nominal Diag bag	190 x 260	N/A -
800418	Nominal Diag bag	260 x 385	N/A -
800419	Diag bag with handle	600 x 510	N/A -
800437	Transport standard label THIS WAY UP	60 x 100	N/A -

## Packaging for the transport of biological samples

- For the transport of category A or B samples
- Kits and jars in accordance with UN 2814 or UN 3373 / transport P620 or P650



Cat. No.	Description	Content	Units/box	Price/box
800447	Complete kit for mailing 4 tubes P650 UN 3373	Minimailbox shipping system: secure transport for the transport of biological materials in accordance with P650 packaging regulations	100	N/A -
800438	Packaging kit P620 UN 2814 for 4 tubes	Complete kit containing a cardboard box, a synthetic shock absorber, a green 500 ml container and 4 absorbing tube/swab holders. The packaging is suitable for air transport	1	N/A -
800439	Packaging kit P650 UN 3373 for 4 tubes	Complete kit containing a cardboard box, a synthetic shock absorber, a green 500 ml container and 4 absorbing tube/swab holders. The packaging is suitable for air transport	1	N/A -
800440	Green container 500 ml with crossbars and 4 absorbing tube holders - P620-P650	Strong, waterproof PP transport container, complete with shock absorbers and 4 absorbing tube/swab holders. Contents are suitable for 4 x 10 ml tubes	1	N/A -
800441	Green container 800ml with crossbars and 4 absorbing tubes/swabs holders - P620-P650	Strong, waterproof PP transport container, complete with shock absorbers and 4 absorbing tube/swab holders. Contents are suitable for 4 swabs	1	N/A -
800442	Post Box UN 2814 for 500 ml green container - Dimensions 100 x 100 x 180 mm	Box UN 2814 suitable for 500 ml green containers	10	N/A -
800443	Post Box UN 2814 for 800 ml green container - Dimensions 100 x 100 x 220 mm	Box UN 2814 suitable for 800 ml green containers	10	N/A -
800444	Post Box UN 3373 for 500 ml green container - Dimensions 100 x 100 x 180 mm	Box UN 3373 suitable for 500 ml green containers	10	N/A -
800445	Polystyrene box UN 3373 for 35 l box	Grey polystyrene foam box, reusable, for sending biological samples in packaged transport	1	N/A -
800446	35 l mailbox for box 800446	Brown cardboard box for isothermal box 800446	20	N/A -

## Transport blisters for category B biological samples

- For the protection of tubes, jars and swabs during transport
- In polypropylene, Thickness 0.8 mm

Cat. No.	Description	Price
800421	Cytoblister pack for tube and swab	N/A -
800422	Transport Blister Para-sito	N/A -
800423	Transport blister faeces, 1 tube	N/A -
800424	Transport blister faeces, 2 tubes	N/A -
800425	Transport blister container 15 ml	N/A -
800426	Blood collection blister, 1 tube	N/A -
800427	Blood collection blister, 2 tubes	N/A -
800428	Blood collection blister, 3 tubes	N/A -
800429	Blood collection blister pack 6 tube	N/A -
800430	Transport blister for 1 swab	N/A -
800431	Transport blister for 2 swabs	N/A -
800432	Multi-swab and Petri dish transport blister	N/A -
800433	Multi-tube transport blister	N/A -





## Transport kits UN3373 and UN 2814



- Transport box with flap
- Standard black screen printing UN 2814 or UN 3373

- Tamper-evident container
- Customised printing on request

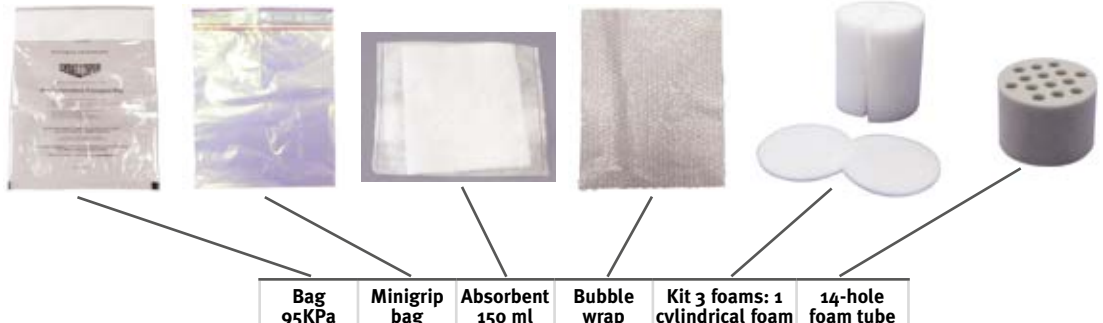

Cat. No.	Type	Ext. dim. L x W x H (mm)	Features of the jar and box	Bag 95KPa Type A5	Minigrip bag	Absorbent 150 ml	Bubble wrap 30 x 40 cm	Kit 3 foams: 1 cylindrical foam block for 2 tubes + 2 foam washers	14-hole foam tube holder	Conformity	Price	
800000	650ml standard UN 3373	100 x 100 x 200	Jar 650 ml (Ø x H: 75 x 150 mm), tamper-proof closure, aluminised heat protection box	X	X	X	X	-	-	ADR/IATA P 620 & P 650 (UN 3373 - UN 2814 -UN 2900) or the carriage of biological substances of category A & B N° UN 918 208	N/A -	
800011	650ml standard UN 2814			X	X	X	X	-	-		N/A -	
800012	1000 ml UN 3373	135 x 135 x 190	Screw-top jar 1000 ml, (Ø x H: 110 x 150 mm), certified IBE / BVI 95 KPa, Box with locking tabs UN 3373 + 2 arrows Delivered assembled	-	-	-	-	X	X	ADR/IATA P 620 /UN 3373 for the transport of biological substances of category B	N/A -	
800008				-	-	X	X	-	-		N/A -	
800006	1250 ml standard UN 2814	123 x 123 x 196	Jar with screw closure, 1250 ml (Ø x H: 100 x 160), watertight seal	X	X	X	X	-	-	ADR/IATA P 620 & P 650 (UN 3373 - UN 2814 -UN 2900) for the transport of biological substances of category A & B N° UN 991 837	N/A -	
800009	1250 ml standard UN 3373			-	-	-	X	-	X		N/A -	
800004A				-	-	-	X	X	-		N/A -	
800010				-	X	X	X	X	-		-	N/A -
800013				-	-	-	X	-	X		N/A -	
800007	-			-	-	-	-	X	X		N/A -	
800005	2000 ml standard UN 3373	165 x 160 x 217	Jar Ø x H: 120 x 184, Calibration REF	X	-	x 2	X	-	-	ADR/IATA P 650 (UN 3373 - UN 2900) for the transport of biological substances in category B	N/A -	

See also: cold transport kits "Cryopack modules", polair pack and Cat. No. o80394, pages 782 - 783.

## Individual autoclavable bags



PP biohazard printout

Recommendation: to withstand the autoclave, the bags should not be sealed.



Unprinted PP

- For autoclaving petri dishes, tubes, jars or other contaminated products
- Unprinted bags: in translucent PP
- Printed bags with graphic "biohazard" symbol: in transparent PP
- Resistant to 121 °C
- Thickness: 40 µm
- Capacity: 3 to 33 litres

Cat. No.	H x L (mm)	Volume (l)	Printed bags	Units/box	Price/box
140230	400 x 255	3	No	500	N/A -
999740	400 x 255	3	Yes	500	N/A -
999741	500 x 300	9	Yes	500	N/A -
999742	600 x 400	14	Yes	500	N/A -
140233	780 x 400	21	No	500	N/A -
999743	780 x 400	21	Yes	500	N/A -
140234	780 x 600	33	No	500	N/A -
999744	780 x 600	33	Yes	500	N/A -

## Red autoclave bags

- Autoclave bags with Biohazard symbol and text
- Integrated sterilisation indicator
- HDPE bags autoclavable up to 121 °C, polypropylene bags autoclavable up to 135 °C



L x H (cm)	Units/box	30 µm thick bags In HDPE		50 µm thick polypropylene bags	
		Cat. No.	Price/box	Cat. No.	Price/box
36 x 48	200	045890	N/A -	085001	N/A -
48 x 58	200	045891	N/A -	085002	N/A -
64 x 89	200	045892	N/A -	085003	N/A -
79 x 97	200	045893	N/A -	085004	N/A -
97 x 122	100	045894	N/A -	085005	N/A -

## Red autoclave bags with sterility indicator

- Made of polyethylene, red
- White sterility indicator, turning black on autoclaving
- Printing of the "Biohazard" symbol and safety text in English, French, German and Spanish
- Autoclavable at 121 °C



Cat. No.	Dimensions W x H (mm)	Volume (l)	Thickness (µm)	Units/box	Units/box	Price/box
851012	210 x 290	1.5	20	100	1000	N/A -

### Accessory

Cat. No.	Description	Price
851013	Table stand + 100 bags	N/A -

## Biohazard autoclave bags

### Autoclave bags Biohazard red

- In red polypropylene
- Biohazard Symbol and text
- Sterilisation indicator
- Autoclavable at 134 °C



Cat. No.	L x W (cm)	Volume (l)	Thickness (µm)	Units/box	Price/box
851030	40 x 78	38	50	500	N/A -
851031	60 x 80	60	50	500	N/A -

### Autoclave bags Biohazard yellow

- Made of yellow polyethylene
- Biohazard Symbol and text
- Very durable with a large seam on the bottom
- Sterilisation indicator
- Autoclavable at 121 °C



Cat. No.	L x W (cm)	Volume (l)	Thickness (µm)	Units/box	Price/box
851032	30 x 50	8	50	500	N/A -
851033	60 x 80	60	50	500	N/A -

## Biohazard autoclavable bags

- Polypropylene bags
- Thickness 50 µm
- Biohazard Symbol and text
- Sterilisation indicator
- Autoclavable at 134 °C



Cat. No.	L x W (cm)	Volume (l)	Units/box	Price/box
851026	30 x 50	8	100	N/A -
750228	30 x 50	8	500	N/A -
851027	40 x 78	38	100	N/A -
750229	40 x 78	38	500	N/A -
851028	60 x 80	60	100	N/A -
750230	60 x 80	60	500	N/A -
851029	70 x 110	110	75	N/A -
750231	70 x 110	110	350	N/A -

## Autoclave bags

- Bags for high temperature autoclave
- Made of thick polypropylene
- Use up to + 139 °C



Cat. No.	Description	Dim. (mm)	Units/box	Price/box
440259	Bags for high temperature autoclave	310 x 660	200	N/A -
440260	Bags for high temperature autoclave	415 x 660	200	N/A -
440261	Bags for high temperature autoclave	610 x 810	200	N/A -
440262	Sterilisation indicator tape	19	48	N/A -

## Adhesive waste bags



- Made of polypropylene
- Autoclavable at 121 °C
- Equipped with an external adhesive strip
- Can be fixed on any support (bench, table, hood)
- Clear the work surface and accept all soiled waste (tips, tubes, rags, etc.)
- Max. load capacity: 1.3 kg
- Thickness: 25.4 µm

Cat. No.	L x W (mm)	Units/box	Price/box
045898	203 x 254	50	N/A -
045899	305 x 406	50	N/A -

## Waste bag holder



Epoxy coated steel holder for holding waste bags and autoclave bags.

Cat. No.	ø x H (cm)	For bags of (cm)	Price
085938	18.5 x 52	30 x 61	N/A -
086633	37 x 60	61 x 76	N/A -
086634	37 x 75	61 x 91	N/A -

## Holder for autoclavable bags



- Delivered unassembled
- Steel holder for the upper part
- Orange polypropylene tray as a reminder that the products contained in the bag are biohazardous
- The small model can be used on the bench

Cat. No.	For bags of (cm)	Dimensions (mm)	Price
085942	30 x 61	185 x 356 x 470	N/A -
085943	61 x 76	356 x 356 x 546	N/A -
085944	61 x 91	356 x 356 x 696	N/A -

## Economical autoclave bags



- Polypropylene autoclave waste bags
- Autoclavable at 121 °C
- Thickness: 0.03 mm
- With or without "Biohazard" printing and sterilisation indicator

L x W (cm)	Unprinted bags without indicator			Biohazard printed bags with sterilisation indicator		
	Cat. No.	Units/box	Price/box	Cat. No.	Units/box	Price/box
30 x 61	086635	100	N/A -	086638	100	N/A -
61 x 76	086636	100	N/A -	086639	100	N/A -
61 x 91	086637	100	N/A -	086640	100	N/A -

## Biohazard polypropylene bags



Thick polypropylene bags for waste requiring sterilisation.

- Autoclavable steel holder (up to 121 °C) Cat. No. 320084 for bag model 320080, holds bag open
- Ideal for bench top use
- Indicator patch (black when autoclaved)

Cat. No.	Dimensions W x H (mm)	Thickness (µm)	Units/box	Price/box
320080	203 x 305	40	500	N/A -
320081	356 x 483	40	200	N/A -
320082	483 x 584	40	200	N/A -
320083	635 x 838	40	200	N/A -

## Support

Cat. No.	Description	Price
320084	Steel holder	N/A -

## Small bag holders for bench waste



Cat. No.	Description	Dimensions (mm)	Units/box	Price/box
045895	Bag holder, white, Round opening	160 x 240 mm (ø x H)	1	N/A -
045895B	Bag holder, red, with rectangular opening	125 x 75 x 203	1	N/A -
045896	Transparent PP bag Autoclavable	200 x 300	100	N/A -
045897	Red-orange bag with Biohazard symbol and sterilisation indicator	220 x 280	100	N/A -

Cat. No.	Description	Price
088865	Polypropylene cover for holder 045895B	N/A -

This epoxy-coated steel holder accepts 20 x 30 cm waste bags. Its small footprint makes it ideal for everyday work and the disposal of small materials: pipette tips, microtubes, on the bench or under the hood. The bags are autoclavable.



## "Biohazard" printed bags with drawstring closure

- ▶ Transparent polyethylene
- ▶ Thickness: 125 µm
- ▶ Yellow and black marking with the Biohazard logo
- ▶ With double drawstring

Cat. No.	Pour boxes	L x W x H (mm)	Units/box	Price/box
041125	53 l	490 x 270 x 400	25	N/A -



## Yellow waste bag with adhesive closure

- ▶ Polyethylene waste bag
- ▶ Yellow
- ▶ Self-adhesive flap closure
- ▶ H x W: 425 x 267 mm
- ▶ Thickness: 20 µm

Cat. No.	Description	Price
074000	Yellow waste bag, adhesive closure	200 units N/A -



## Autoclave bags

### Autoclave bags

Autoclave bags made of polypropylene, for temperatures up to 134 °C, and polyamide for temperatures up to 160 °C. The thickness of these bags is 50 microns.

Cat. No.	Material	L x H (mm)	Thickness (µm)	Volume (l)	Units/box	Price/box
643201	PP	300 x 500	50	10	500	N/A -
644201	PP	400 x 780	50	30	500	N/A -
645201	PP	500 x 780	50	45	500	N/A -
646201	PP	600 x 780	50	65	500	N/A -
030119	PP	600 x 800	50	65	100	N/A -
649201	PP	700 x 1100	50	130	350	N/A -
030121	PP	700 x 1100	50	130	75	N/A -
643401	PA	300 x 500	50	10	500	N/A -
644401	PA	400 x 780	50	30	500	N/A -
646401	PA	600 x 780	50	65	300	N/A -
649401	PA	700 x 1100	50	130	200	N/A -

**Stand** - Height 30 cm - for bag Cat. No. 643201

Cat. No.	Description	Price
851034	Support for bags 300 x 500 mm	N/A -



### Economical autoclave bags

Polypropylene autoclave bags. They can be autoclaved for 30 minutes at 121 °C. The 030118 bags are presented in a practical and clean dispenser box.

Cat. No.	Material	L x H (mm)	Thickness (µm)	Volume (l)	Units/box	Price/box
030118*	PP	200 x 300	50	2	100	N/A -
140236	PP	305 x 660	40	15	500	N/A -
037989	PP	310 x 660	50	15	50	N/A -
140235	PP	420 x 600	40	25	500	N/A -
037487	PP	415 x 600	50	25	50	N/A -
140233	PP	400 x 780	40	21	500	N/A -
140234	PP	600 x 780	40	33	500	N/A -
037991	PP	610 x 810	50	34	50	N/A -

PP: polypropylene \* In dispenser box



## Biohazard waste bags for biological waste



- Made of thick yellow polyethylene
- Clean and convenient (in dispenser box)
- Printed on both sides: "Danger of infection" and Biohazard pictogram

Cat. No.	L x H (mm)	Thickness	Units/box	Price/box
<b>Waste bags with standard closure</b>				
041001	255 x 355	500 gauge	50	N/A -
041024	455 x 760	500 gauge	50	N/A -
<b>Self-adhesive waste bags</b>				
041006	300 x 450	250 gauge	200	N/A -

## DASRI waste bags



- In yellow Flexitène® polyethylene
- With the inscription "Waste from care activities with infectious risks"
- Unsuitable for perforating waste
- Complies with NF X30-501

Cat. No.	Volume (l)	Dimensions W x H (mm)	Thickness (µm)	Units/box	Price/box
952000	15	400 x 350	19	500	N/A -
952001	20	450 x 450	19	500	N/A -
952002	30	500 x 650	21	500	N/A -
952003	50	680 x 750	24	500	N/A -
952004	100	820 x 900	25	250	N/A -
952005	110	700 x 1050	28	250	N/A -

## Printed autoclave bags



- Made of polypropylene
- Thickness: 50 µm
- Can be used up to 134 °C (3 minutes)
- "Biohazard" printing

Cat. No.	Dimensions (mm)	Units/box	Price/box
140225	305 x 660	200	N/A -
140226	420 x 600	200	N/A -
140227	600 x 780	200	N/A -

## Heavy-duty autoclavable bags



- Polypropylene, autoclavable at 121 °C for 20 minutes
- Thickness: 100 µm

Cat. No.	Sheet (mm)	Units/box	Price/box
030116	600 x 800	125	N/A -
030129	700 x 1100	75	N/A -

## Low or high density polyethylene waste bags

### High density polyethylene waste bags

- High density polyethylene
- Star welds
- Suitable for all types of activities

Volume (l)	Dim. (mm)	Thickness (µm)	White	Black	Blue	Bags/roll	Price/roll
5	335 x 350	10	852007	-	-	50	N/A -
10	400 x 450	10	852008	-	-	50	N/A -
20	450 x 500	10	852009	-	-	50	N/A -
30	500 x 650	11	-	852010	-	50	N/A -
50	680 x 750	14	-	852011	852049	50	N/A -
110	700 x 1050	18	-	852012	-	50	N/A -



### Low density polyethylene waste bags - Made of low density polyethylene, in rolls. Traditional welds.

Vol. (l)	Dim. (mm)	Thickness (µm)	White	Price roll of 25 bags	Black	Price roll of 25 bags	Tansp.	Price roll of 25 bags	Yellow	Price roll of 25 bags	Red	Price roll of 25 bags	Blue	Price roll of 25 bags	Green	Price roll of 25 bags
30	500 x 650	25	852014B*	N/A -	852013*	N/A -	-	-	-	-	-	-	-	-	-	-
50	680 x 750	30	852021	N/A -	852019	N/A -	852020	N/A -	852024	N/A -	852006	N/A -	852049*	N/A -	852023B***	N/A -
100	820 x 870	35	-	-	852025	N/A -	852029	N/A -	-	-	-	-	-	-	-	-
100	820 x 870	45	-	-	852026	N/A -	-	-	-	-	-	-	-	-	-	-
100	820 x 870	55	-	-	852027	N/A -	-	-	-	-	-	-	-	-	-	-
100	820 x 870	65	-	-	852028	N/A -	-	-	-	-	-	-	-	-	-	-
110	700 x 1050	30	-	-	852030	N/A -	-	-	-	-	-	-	-	-	-	-
110	700 x 1050	35	-	-	852031	N/A -	-	-	-	-	-	-	-	-	-	-
110	700 x 1050	40	852037	N/A -	852032	N/A -	852036	N/A -	852040	N/A -	-	-	852038	N/A -	852039	N/A -
110	700 x 1050	55	-	-	852033	N/A -	-	-	-	-	-	-	-	-	-	-
110	700 x 1050	65	-	-	852034	N/A -	-	-	-	-	-	-	-	-	-	-
110	700 x 1050	75	-	-	852035**	N/A -	-	-	-	-	-	-	-	-	-	-
130	800 x 1150	35	-	-	-	-	852045	N/A -	-	-	-	-	-	-	-	-
130	800 x 1150	45	-	-	852041	N/A -	-	-	-	-	-	-	-	-	-	-
130	800 x 1150	55	-	-	852042	N/A -	852046	N/A -	-	-	-	-	-	-	-	-
130	800 x 1150	65	-	-	852043	N/A -	-	-	-	-	-	-	-	-	-	-
130	800 x 1150	75	-	-	852044	N/A -	-	-	-	-	-	-	-	-	-	-

\* Sold by 50, price indicated for 50 bags \*\* Sold by 20, price indicated for 20 bags \*\*\* Sizes 852023B: 680 x 800 mm

## Garbage bags

Polyethylene waste bags from 5 litres to 130 litres. Thickness adapted to the needs of the laboratory.

Cat. No.	Dimensions (mm)	Volume (l)	Thickness (µm)	With drawstrings	Colour	Bags/roll	Price/roll
140905B	325 x 350	5	12	Yes	White	50	N/A -
140906B	400 x 450	10	12	Yes	White	50	N/A -
999735	500 x 650	30	30	Yes	Black	20	N/A -
140909	680 x 750	50	35	Yes	Black	25	N/A -
140909C	680 x 750	50	16	Yes	White	50	N/A -
140910	820 x 870	100	55	Yes	Black	25	N/A -
999736	700 x 1070	110	55	Yes	Black	20	N/A -
140911B	700 x 1070	110	55	Yes	White	200	N/A -
140912	820 x 1100	130	55	Yes	Black	10	N/A -



## General purpose bin bags

- With plastic drawstrings
- Suitable for laboratory and general waste
- Made of polyethylene

Cat. No.	Capacity (l)	Dimensions W x H (cm)	Thickness (µm)	Colour	Units/box	Price/box
711938	5	32 x 35	20	White	1000	N/A -
711939	10	40 x 45	20	White	1000	N/A -
711940	20	45 x 50	20	White	1000	N/A -
711941	30	50 x 70	35	Grey	500	N/A -
711942B	50	68 x 75	25	Grey	500	N/A -
711943	100	82 x 88	60	Grey	200	N/A -
711944	100	82 x 88	70	Grey	200	N/A -
711945	110	70 x 110	60	Grey	200	N/A -
711946	110	70 x 110	18	Transparent	200	N/A -
711947	110	70 x 110	70	Grey	200	N/A -
711948	110	70 x 110	80	Grey	100	N/A -
711949	130	80 x 120	70	Grey	100	N/A -
711950	130	80 x 120	80	Grey	100	N/A -
711951	130	80 x 135	80	Grey	100	N/A -





## Metal drawstrings



Twist drawstrings on autoclave bags.  
To be cut to the desired length.

- Wire in a sheath of virgin vinyl
- 457 meter roll
- Withstands autoclaving at 121 °C for 20-30 minutes

Cat. No.	Description	Price the roll
085957	Metallic closing tie	N/A -

## Rubber-coated silicone ties



Flexible ties for closing the bags before autoclaving.

- With sliding ring to close the loop around the bag
- Loop opening up to 100 mm diameter
- Width 5 mm
- Available in three assorted colours: red, blue, yellow

Cat. No.	Description	Price 30 units
085949	Rubber-coated silicone tie	N/A -

## Clavies clip



Plastic clip to seal autoclavable bags.

- Closes or opens with one hand
- Single use
- Size of inner loop 1.1 cm
- Temperature resistant up to 134 °C

Cat. No.	Description	Price 100 units
085950	Clavies clip	N/A -

## Polypropylene or polyallomer clips for bag closure

Seal your bags with a single click!  
2 lengths: 30 or 60 mm.



Colour	Polypropylene		Polyallomer	
	Lenght 30 mm	Lenght 60 mm	Lenght 65 mm	Lenght 150 mm
White	046300	046307	046315	046320
Red	046301	046308	046316	-
Yellow	-	046309	046317	-
Blue	046303	046310	046318	-
Green	046304	046311	046319	-
Black	046305	046312	-	-
Natural	046306	-	046314	-
Price/ 10 units	N/A -	N/A -	N/A -	N/A -

## 120 l bag holders



- Made of HDPE for use from -40 to +90 °C
- A handle and 2 wheels for easy movement
- Easy bag insertion and removal
- Pedal to prevent contamination (depending on model)
- Interchangeable coloured lid (depending on model) for easy sorting; lid can be held in open position
- Economy version (without lid and pedal) and undermount version available

Cat. No.	Model	Lid	Pedal	H. (cm)	Price
212147	Pole bag holder without lid	Without	Yes	97	N/A -
212148	White lid for 212147	-	-	-	N/A -
212149	Blue lid for 212147	-	-	-	N/A -
212150	Red lid for 212147	-	-	-	N/A -
212151	Yellow lid for 212147	-	-	-	N/A -
212152	Green lid for 212147	-	-	-	N/A -
212153	Pole bag holder 120 l + white lid	-	Yes	97	N/A -
212154	Pole bag holder 120 l + blue lid	-	Yes	97	N/A -
212155	Pole bag holder 120 l + red lid	-	Yes	97	N/A -
212156	Pole bag holder 120 l + yellow lid	-	Yes	97	N/A -
212157	Pole bag holder 120 l + green lid	-	Yes	97	N/A -
212158	Economical 120 l holder	Without	Without	97	N/A -
212159	Pole bag holder for worktop (90 l)	Without	Without	75	N/A -

## 50 litre waste bin

- Made of robust polypropylene
- Tilting lid, flap holding system in open position
- Dim. (H x L x D): 68 x 40 x 33 cm



Cat. No.	Description	Price
999245	50 litre bin	N/A -

## 100 litres pedal waste bin

- Foot pedal opening to avoid direct contact with the container
- Made of polypropylene
- Overall dimensions: 520 x 480 x 930 mm
- Equipped with 2 plastic castors
- Rounded corners for easy cleaning
- Supplied with two plastic hooks for attaching the bag (use a 100 or 130 litre bag)
- Lids in 5 different colours suitable for selective sorting



Colours	White	Blue	Green	Red	Yellow	Price
Cat. No.	001302	001303	001304	001305	001306	N/A -

## Fire safety bins

Volume (l)	Pearl grey	Red Black	Metal grey Black	Price
15	060132	060133	060134	N/A -
30	060135	060136	060137	N/A -
50	060138	060139	060140	N/A -
80	060143	060144	060145	N/A -
110	060148	060149	060150	N/A -



## Pedal bins



- Capacity: 30 l
- Dimensions: 41 x 39 x 44 cm

Colours	White	Red	Yellow	Price
Cat. No.	039666	039667	039668	N/A -

## Stainless steel benchtop disposal can

- Stainless steel
- Infrared detector lid opening
- Biohazard label
- ø x H: 12.7 x 19 cm



Cat. No.	Description	Price
088745B	Stainless steel benchtop disposal can	N/A -

## Polypropylene pedal bin

- Polypropylene bin
- Can be used from -20 °C to +90 °C
- Perfectly stable
- With white plastic inner bucket + handle

Cat. No.	Shape	Volume (l)	Dimensions W x D x H (mm)	Price
212093	Square	4	245 x 195 x 225	N/A -



212093

## Pig HAZ-MAT Chemical Absorbent pads



- 8 layers of fine polypropylene fibres
- For the absorption of a wide range of chemicals (e.g. 98% sulphuric acid, 30% sodium hydroxide)
- Pads with honeycomb pattern: faster absorption

### Pads in a bag

Cat. No.	Description	Dimensions (mm)	Absorption (l/bag)	Pads/bag	Price the bag
333202	Heavyweight mat pads	380 x 510	41.8	50	N/A -
333203	Heavyweight mat pads	380 x 510	83.6	100	N/A -
333204	Lightweight mat pads	380 x 510	83.6	200	N/A -

### Pads in a box

Cat. No.	Description	Dimensions (mm)	Absorption (l/box)	Pads/box	Box/cardboard box	Price/cardboard box
333206	Heavyweight mat pads in Box dispenser,	250 x 330	37.1	100	1	N/A -
333207	Heavyweight mat pads in Bench Box dispenser,	330 x 250	37.1	25	4	N/A -

### Roll

Rip&fit rolls: delivered in a dispenser box.

Cat. No.	Description	Dimensions (mm x m)	Absorption (l/bag)	Rolls/bag	Price the bag
333205	Heavyweight mat roll	760 x 46	152.4	1	N/A -
333208	Heavyweight mat roll in Rip&fit dispenser box	380 x 18	29.7	1	N/A -

## Lab Sorb

- For gelling of liquid products
- Lab Sorb granules gel aqueous compounds or solvents in minutes
- Gelled product is easily disposed of
- 450 g

Cat. No.	Description	Price
053489	Lab Sorb, 450 g	N/A -



## Universal absorbent for oils and chemicals



- Absorbs chemicals or oils
- Fine polymer-based granules, dust-free
- For all liquids
- Absorbs up to 75 times its own weight
- Economic
- Coloured indicator depending on the compound to be absorbed: yellow for acid-based products, red for alkaline products
- Simply sprinkle on the spilled product, collect in gel form with a shovel or spatula (not supplied)

Cat. No.	Description	Price
452000	Chem-solute chemical absorbent, 1800 ml	N/A -
452001	Chem-solute chemical absorbent, 4000 ml	N/A -

## HandySorb Absorbents



- Inert polypropylene sheets and cushions
- Each leaf absorbs up to 25 times its weight
- Do not react with any spilled substances
- NoTouch system: no user contact with the spilled liquid
- User range: up to 1.83m for more effective use in hard-to-reach areas

Cat. No.	Description	Units/box	Price/box
834423	HandySorb System Starter Kit with absorbent pads	1	N/A -
834420	Pads refills with adapter for HandySorb system	100	N/A -
834421	NoTouch universal pads for HandySorb system	25	N/A -
834422	NoTouch universal cushions for HandySorb system	10	N/A -

## Beta-safe paper



- Activated carbon paper to absorb volatile radioisotopes (<sup>35</sup>S)
- Prevents contamination of laboratories

Cat. No.	Description	Units/box	Price/box
034918	Beta-Safe sheets 20.5 x 25.4 cm	50	N/A -



## Chemical spill response kits

► Emergency response kits, in case of a chemical spill

TIP



See our radioactivity protection containers on page 1266 see Cat. No. 028033 and related



333218

### Soft bags

Cat. No.	Type of container	Kit Contents	Absorption capacity	Price the kit
333210	High visibility bag with cord closure, for carrying and hanging	2 temporary disposal bags, 2 ties, 20 heavy weight sheets, 1 pad	10.4 l	N/A -
333224	High visibility yellow bag with handles and flap closure	5 temporary disposal bags + ties, 28 heavy-weight sheets, 4 absorbent pads	34.7 l	N/A -
333217	Kit with high visibility vinyl bag with velcro fasteners specific to forklift trucks, for interventions at height; "box" lid for quick access	1 roll Ø 8 cm x W 117 cm, 20 triple thickness absorbent sheets 25 x 33 cm, 2 disposable bags and ties 46 x 76 cm, 1 pig® plug-n-seal® patching paste 454 g, 1 chemical spill kit compatibility guide, 1 spill kit trolley	10.4 l	N/A -
333231	Compact transparent bag with handle	1 compact pig® spill kit, 6 absorbent mat pads, 2 pads, 2 temporary disposal bags, 2 ties	6.7 l	N/A -
333211	Clip-on bag easy to close, hang and carry for emergency response	12 sheets, 1 pad, 1 collection bag	13 l	N/A -
333220	Clip-on bag easy to close, hang and carry for emergency response	25 sheets, 2 pads, 2 recovery bags	26.9 l	N/A -
333221	Transparent bag with zip closure	3 pads for chemicals 8 x 117 cm, 12 sheets for chemicals 38 x 51 cm, 2 collection bags with ties 76 x 46 cm	18.5 l	N/A -
333218	Kit Clear Cube: durable, transparent cubic bag, easy opening, shoulder strap for carrying/hanging	2 pads Ø 8 cm x W 3 m, 3 pads W Ø 8 x 117 cm, 6 cushions 20 x 20 cm, 30 triple thickness absorbent sheets 38 x 51 cm, 5 disposable bags and ties 46 x 76 cm, 1 spill kit trolley, 1 chemical spill kit compatibility guide	54.4 l	N/A -
333219	-	Refill for 333218	54.4 l	N/A -

### Intervention buckets and drums

Cat. No.	Type of container	Kit Contents	Volume containing	Absorption capacity	Price the kit
333214	UN approved light-weight container (UN1H2/Y30/S)	4 absorbent mat pads, 2 absorbent pads, 6 tamper evident labels	24.6 l	17 l	N/A -
333227	360 l UV-resistant drum (outdoor storage), classified UN1H2/X295/S for packing groups I, II and III	Medium density PE container, mats, dikes, pads and cushions in polypropylene	360 l	237 l	N/A -
333228	-	Refill for 333227	-	237 l	N/A -
333229	Container 76 l UV-resistant, waterproof and chemical-resistant, classified as UN1H2/ X75/S, UN1H2/Y100/S for packing groups I, II and III	Overpack Ø 58.5 x 48 cm, 5 temporary disposal bags with ties, 6 heavy-weight sheets, 5 large cushions, 6 absorbent pads	76 l	40.9 l	N/A -
333230	-	Refill for 333229	-	40.9 l	N/A -



333214

### Trolleys

Cat. No.	Type of container	Kit Contents	Absorption capacity	Price / kit
333232	High visibility PE trolley with full height double doors, adjustable shelves and 20 cm castors	5 temporary bags + ties, 1 roll of absorbent sheets, 4 cushions, 5 pads	47.4 l	N/A -
333233	-	Refill for 333232	47.4 l	N/A -
333225	High visibility bag with box closure, mounted on an easy to manoeuvre trolley	30 sheets - heavy-weight, 12 Haz-Mat pads, 6 absorbent pads 117 cm, 5 temporary disposal bags, 5 ties, 1 chemical compatibility guide & manual	52.8 l	N/A -
333226	-	Refill for 333225	52.8 l	N/A -
333215	Large high visibility trolley with doors and lid, 20 cm wheels	1 roll of mat pad 51 cm x 41 m, 50 mat sheets 38 x 51 cm, 2 pads 8 cm x 3 m, 6 pads 8 x 117 cm, 8 cushions 20 x 20 cm, 40 wipes 31 x 33 cm, 10 waste bags with ties 91 x 152 cm, 1 spill kit trolley, 1 chemical spill kit compatibility guide, 1 large spill trolley 75 x 76 x 128 cm	173.2 l	N/A -
333216	-	Refill for 333215	173.2 l	N/A -



333225

## EZwaste exhaust air filters

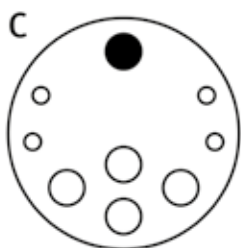
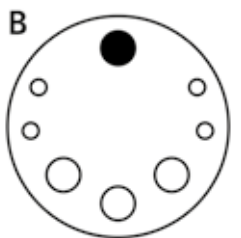
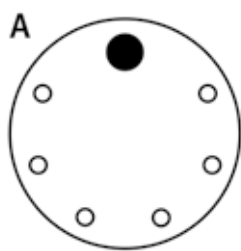

- ▶ EZwaste activated carbon filter
- ▶ Retains chemical vapours
- ▶ Easy disposal mechanism for solvent waste

Each kit contains:

- an HDPE container;
- an 83 mm cap open at the top;
- an 83 mm closed cap;
- an EZwaste filter;
- an elbow fitting for EZwaste filter;
- unused port caps.

### EZwaste Kit

Configuration	Cat. No.	Volume (l)	Port 1/4"	Port 1/8"	Price
A	311164	Single cap	0	6	N/A -
	311165	4	0	6	N/A -
	311166	5	0	6	N/A -
	311167	10	0	6	N/A -
	311168	20	0	6	N/A -
B	311169	Single cap	3	4	N/A -
	311170	4	3	4	N/A -
	311171	5	3	4	N/A -
	311172	10	3	4	N/A -
	311173	20	3	4	N/A -
C	311174	Single cap	4	4	N/A -
	311175	4	4	4	N/A -
	311176	5	4	4	N/A -
	311177	10	4	4	N/A -
	311178	20	4	4	N/A -

### Replacement EZwaste filter

Cat. No.	Units/box	Price/box
311159	1	N/A -
311160	2	N/A -
311161	5	N/A -

## Ezwaste safety funnels



- ▶ HDPE funnel and lid
- ▶ Seal on the lid
- ▶ Filter to retain magnetic bars
- ▶ Stem that reduces the emission of volatile organic compounds
- ▶ Stem length: 279.4 mm

Cat. No.	Volume (ml)	Neck (mm)	Dimensions L x D (mm)	Price
311179	450	38-430	177.8 x 127	N/A -
311180	450	53	177.8 x 127	N/A -
311181	450	70	177.8 x 127	N/A -
311182	450	83	177.8 x 127	N/A -
311183	2000	38-430	279.4 x 228.6	N/A -
311184	2000	53	279.4 x 228.6	N/A -
311185	2000	70	279.4 x 228.6	N/A -
311186	2000	83B	279.4 x 228.6	N/A -

## Safety funnels



- ▶ HDPE funnel and lid
- ▶ PP cap
- ▶ Vent with PTFE membrane
- ▶ Patented models
- ▶ Mount on a bottle for solvent recovery
- ▶ The lid prevents evaporation of organic waste

Cat. No.	Neck (mm)	Price
029385	38 - 430	N/A -
029386	83B	N/A -

## Drainage filter for SafetyWastecaps

- Absorption of solvent vapours
- Display of filter saturation on the cap
- Splash guard

Cat. No.	Size	Volume of chemical recovery canister max	Lifespan	Units/box	Price/box
096864	M	20 litres	6 months	2	N/A -

### Caps

Cat. No.	Thread	Connectors			Price
		Capillaries (out. Ø 2.3 to 3.2 mm)	Tubes (6.4 to 9 mm)	Evacuation filter	
096865	GL 45	2	1	1	N/A -
959158	S50	3	-	1	N/A -
959045	S51	3	-	1	N/A -
959159	B53	4	1	1	N/A -
948553	S55	2	1	1	N/A -
959160B	S60/61	3	-	1	N/A -
959161	B63	2	1	1	N/A -



## Safety bottles with funnel

- 4 litre HDPE or 10 litre fluorinated HDPE bottle
- For temporary storage of liquid waste
- The funnel is screwed onto the bottle
- With vent
- A polypropylene filter retains large particles and/or magnetic bars

Cat. No.	With bottle (litre)	Price
029387	4	N/A -
029388	10	N/A -



## Safety funnel

- In stainless steel
- Anti-flame
- Threaded connection
- Diameter 120 mm
- Total height 285 mm
- Funnel height: 125 mm
- Drain hose Ø 3.5 cm
- With overflow protection

Cat. No.	Description	Price
795865	Stainless steel safety funnel	N/A -





## SCAT safety funnels

- With ball valve or lid
- Supplied with sieve and anti-splash funnel
- With or without lance
- Conductive (grounded) or not
- Funnel diameter 180 mm
- Anti-splash funnel diameter: 200 mm



### With ball valve

Thread	Conductive with lance		Non-conductive with lance	
	Cat. No.	Price	Cat. No.	Price
S50	959123	N/A -	959130	N/A -
S51	959124	N/A -	-	-
S55	959125	N/A -	-	-
S60/61	799635	N/A -	799633	N/A -
S65	959126	N/A -	-	-
S90	959128	N/A -	959132	N/A -

### Closing lid

Thread	Conductive with lance		Non-conductive with lance		Conductive without lance		Non-conductive without lance	
	Cat. No.	Price	Cat. No.	Price	Cat. No.	Price	Cat. No.	Price
GL45	-	-	959142	N/A -	959148	N/A -	-	-
S50	959138	N/A -	959143	N/A -	-	-	959153	N/A -
S51	-	-	959144	N/A -	-	-	958760	N/A -
S55	959140	N/A -	959145	N/A -	959149	N/A -	959154	N/A -
S60/61	799634	N/A -	959146	N/A -	959150	N/A -	958761	N/A -
S65	959141	N/A -	959147	N/A -	959151	N/A -	959155	N/A -

### Accessories

#### With ball valve

	Conductive funnel	Price	Non-conductive funnel	Price
Sieves	959134	N/A -	959135	N/A -
Splash guard	959136	N/A -	959137	N/A -

#### Closing lid

	Conductive funnel	Price	Non-conductive funnel	Price
Sieves	959134	N/A -	959135	N/A -

### Packs

Includes conductive canister with level control, safety funnel.

Cat. No.	Canister volume	Funnel	Retention bins	Price
959119	10 litres*	with lid	Yes	N/A -
959120	10 litres	With ball valve	No	N/A -
959121	20 litres	With ball valve	No	N/A -

\*Without level control.

## SHARPSAFE Waste boxes

Maximum protection for the storage of contaminated objects such as syringes and needles.

- Adequately sized and sized to allow one-way evacuation of used materials, including secured materials
- Incinerability without fumes
- Tamper-proof, hermetically sealed closure system to prevent leakage or spillage of the contents during disposal
- Residual liquid tightness, puncture resistance
- Compliant with NF302, NFX 30-500 and ADR



Cat. No.	Volume	H x L x W (mm)	Brand NF302	Standard NFX30-500	Units/box	Price/box
140383	300 ml	130 x 105 x 50	Yes	Yes	100	N/A -
140410	450 ml	170 x 105 x 50	Yes	Yes	100	N/A -
140282	600 ml	224 x 108 x 52	Yes	Yes	100	N/A -
140283	1 litre	187 x 108 x 90	Yes	Yes	100	N/A -
140411	3 litres	203 x 197 x 126	Yes	Yes	50	N/A -
140284	2 litres	177 x 197 x 126	Yes	Yes	50	N/A -
140285	4 litres	245 x 175 x 175	Yes	Yes	50	N/A -
140286	7 litres	380 x 175 x 175	Yes	Yes	50	N/A -
140287	7.5 litres	610 x 150 x 100	No	No	20	N/A -
140422	9 litres	291 x 292 x 195	Yes	Yes	20	N/A -
140289	13 litres	353 x 292 x 195	Yes	Yes	20	N/A -

### Stands

Cat. No.	Type	For SharpSafe	Price
140384	Oblique for laminar flow hood	4 l - 7 l	N/A -

### Accessories

Cat. No.	Description	Price
140409	Tray for Sharpsafe 1 l, 2 l, and 3 l (10 units)	N/A -

## Approved waste containers

- Puncture resistant
- Indication of the maximum filling level
- Lids with temporary and permanent closure
- Notches for the release of all types of needles
- Autoclavable, incinerable without fumes
- Compliant with NF302, NF X30-511 and ADR standards

Volume (l)	Dim. (W x L x H) (mm)	Photo	Cat. No.	Units/box	Price/box	Cat. No.	Units/box	Price/box
<b>Pocket waste boxes</b>								
0.4	123 x 62 x 165	A	168000A	10	N/A -	168000	70	N/A -
<b>Square waste boxes</b>								
2	151 x 151 x 200	B	-	-	-	168001B	62	N/A -
3	151 x 151 x 238	B	-	-	-	168002B	60	N/A -
4	167 x 167 x 248	B	-	-	-	168003B	52	N/A -
5	215 x 215 x 185	B	-	-	-	168004B	30	N/A -
5 (high form)	167 x 167 x 300	B	-	-	-	168005B	40	N/A -
6 (high form)	167 x 167 x 388	B	-	-	-	168006B	36	N/A -
<b>Cylindrical waste boxes</b>								
0.6	∅ 100 x 145	C	-	-	-	168007	100	N/A -
0.8	∅ 100 x 184	C	168008A	10	N/A -	168008	100	N/A -
1.5	∅ 140 x 165	C	168009A	10	N/A -	168009	100	N/A -
2	∅ 140 x 210	C	168010A	5	N/A -	168010	75	N/A -
5	∅ 213 x 195	C	168011A	5	N/A -	168011	55	N/A -
7	∅ 248 x 195	C	168012A	10	N/A -	168012	40	N/A -
<b>Waste boxes for trolleys</b>								
3	155 x 155 x 220	D	168013A	10	N/A -	168013	40	N/A -
5	220 x 220 x 210	D	168014A	10	N/A -	168014	40	N/A -
10	220 x 220 x 350	D	168015A	10	N/A -	168015	30	N/A -



## Destruction containers



Polypropylene destruction containers allow the collection of soiled products such as syringes, needles or Pasteur pipettes. The bottles are equipped with an attached cap that can be closed irreversibly when the bottle is full. Complies with NF X 30- 511.

Cat. No.	Volume (l)	Dimensions (mm)	Units/box	Price/box
999753A	0.6	130 x 114 x 72	1	N/A -
999754A	0.8	170 x 114 x 72	1	N/A -
999751A	1.1	230 x 114 x 72	1	N/A -
999752A	1.8	140 x 195 x 135	1	N/A -
999750A	7	390 x 195 x 135	1	N/A -

## 30 l, 50 l and 60 l waste containers



- Drums and lids to be ordered separately, in polypropylene
- Volumes available: 30, 50 and 60 litres
- Different colours according to model
- Yellow containers delivered with label
- 2 lid versions: with handle or with lid
- Ergonomic side handles
- Container complies with ISO 23907 perforation and tightness standards and NFX 30-505 and NFX 30-511 standards

Volume (l)	30	50	60
Dimensions L x D x H (mm)	404 x 334 x 315	404 x 334 x 517	404 x 334 x 646
Weight (kg)	0.72	1.125	1.325
Container yellow without lid	671135	671138	671139
Black container without lid	671136	-	671140
Blue container without lid	671137	-	-
Price	N/A -	N/A -	N/A -
Standard handle lid	671141	671141	671141
Price	N/A -	N/A -	N/A -
Porthole lid	671142	671142	671142
Price	N/A -	N/A -	N/A -

### Accessories

Cat. No.	Description	Price
671143	Pedal trolley for 2-wheel containers	N/A -
671144	Pedal trolley for 4-wheel containers	N/A -

## Biohazard waste containers



- Autoclavable with its waste
- Uses a standard autoclavable bag
- Hinged lid opens with one hand
- Universal Biohazard symbol in red
- Made of polypropylene
- Tightly sealed bottom

Cat. No.	Volume (l)	Ø x H (mm)	Price
029358	5.5	210 x 270	N/A -
029359	19	280 x 380	N/A -

## Waste boxes for pipettes



- Longer format, especially for contaminated pipettes, but also for needles and syringes
- With anti-recovery valve
- Lockable when full
- L x W x H: 450 x 150 x 160 mm
- Usable capacity: 5 litres

Cat. No.	Description	Units/box	Price/box
030535	Waste box for pipettes*	16	N/A -

\* Deliverable per unit - Pro rata price



## Cardboard waste boxes

- Temporary closure with hinged lid, permanent closure with double flap
- Cardboard container with LDPE bag glued inside for better moisture resistance
- Bag closure ties for better waterproofing
- Reinforced handles
- Maximum load: 8 kg for the 25 l model, 13 kg for the 50 l model
- Economical and environmentally friendly
- In accordance with the Order of 24 Nov. 2003, approved for the transport of dangerous goods by road (ADR)

Volume	12 l	25 l	50 l standard shape	50 l low shape
L x W x H (mm)	200 x 200 x 385	265 x 265 x 378	295 x 295 x 580	398 x 293 x 430
Cardboard box thickness (mm)	2.7	4	2.9	2.7
Type of bag LDPE	LDPE 60 µm	LDPE 90 µm	LDPE 60 µm	LDPE 70 µm
Max. load (kg)	4	8	13	13
Cat. No.	140431	140292	140432	140399
Price/ 10 units	N/A -	N/A -	N/A -	N/A -



## Disposable cardboard and LDPE bins for glass collection

- Rigid self-assembly boxes for the safe disposal of glass shards in the laboratory.
- The glass is safely stored in a strong, waterproof and puncture resistant LDPE bag
- Lid with integrated flap for easy filling, equipped with a sealing device, for use when full
- Instructions for use printed on the boxes



Cat. No.	Description	Dimensions W x D x H (cm)	Units/box	Price/box
232573	60 l disposable floor bin	30 x 30 x 70	6	N/A -
232574	10 l disposable benchtop waste bin	23 x 23 x 26.5	6	N/A -

## Cardboard bins for glass recovery

- Supplied with 50 µm polyethylene bag
- When the box is full, lift the flap opening to the closed position
- 4 language markings (English, German, French, Spanish)
- Delivered flat packed, quick assembly
- Available in 2 sizes



Cat. No.	Dimensions W x D x H (cm)	Units/box	Price/box
948243	30 x 30 x 69	6	N/A -
948244	20 x 20 x 25	6	N/A -

## Cardboard Boxes for infectious waste

- For soft DASRI
- Self-opening bottom
- Lined internally with a 55 µm thick yellow PE bag
- Two carrying handles
- Reinforced corners for extra strength
- Intuitive locking system
- Stackable
- Approval according to NFX 30-507: 2018 and UN 4G/Y15/S/20



Cat. No.	Volume (l)	L x W x H (mm)	Max. weight (kg)	Price 10 units
132111	25 (bottom)	236 x 316 x 375	7	N/A -
132112	50 (top)	290 x 290 x 650	13.5	N/A -

## Cardboard waste boxes for incineration

- For biological waste for incineration
- When the box is full, pull the flap to the closed position
- Supplied with Biohazard 38 µm polyethylene bag
- 4 language markings (English, German, French, Spanish)
- Delivered flat packed, quick assembly
- Available in 2 sizes



Cat. No.	Dimensions W x D x H (cm)	Units/box	Price/box
948076	30.5 x 30.5 x 68.5	6	N/A -
948077	19.6 x 19.6 x 25.4	6	N/A -

# ALUMINIUM FOILS

## Aluminium in Roll

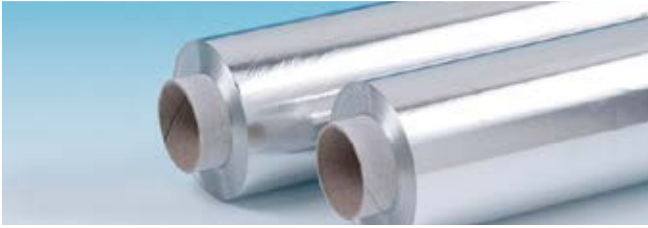

### Aluminium in roll - In a cardboard dispenser box.

Cat. No.	Thickness (µm)	Width (mm)	Length (m)	Price the roll
039448	11	330	50	N/A -
039400	10	326	200	N/A -
039401B	10	440	200	N/A -
039402	14	326	200	N/A -
419005	15	300	150	N/A -
419006	15	450	150	N/A -
419007	30	300	100	N/A -
419008	30	450	100	N/A -
419009	30	500	100	N/A -
419010	30	600	100	N/A -

### Dispensers for refill rolls (except Cat. No. 039603)

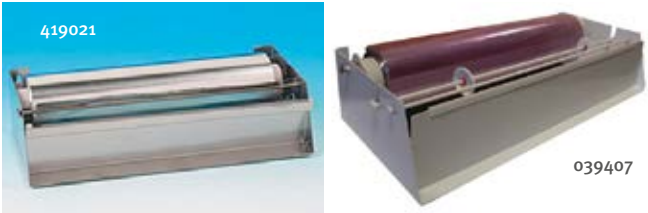

Cat. No.	Description	Price
039406	Double wall-mounted dispenser	N/A -
039407	Horizontal dispenser for rolls width 450 mm	N/A -
419021	Metal dispenser for 300 mm wide rolls	N/A -
419022	Metal dispenser for 450 mm wide rolls	N/A -
419024	Metal dispenser for 600 mm wide rolls	N/A -

### Roll only (refill)

Cat. No.	Thickness (µm)	Width (mm)	Length (m)	Units/box	Price/box
039447	10	326	200	3	N/A -
039586	10	440	200	3	N/A -
039446	11	200	200	3	N/A -
419011	15	300	150	4	N/A -
419012	15	450	150	4	N/A -
039602	20	300	150	4	N/A -
039601	30	300	100	4	N/A -
039603	30	600	100	4	N/A -
419013	30	300	100	4	N/A -
419014	30	450	100	4	N/A -
419015	30	500	100	4	N/A -
419016	30	600	100	4	N/A -

## Reel for aluminium roll



- Made of 3.4 mm white epoxy wire
- Only for 70 m aluminium roll
- Reel length: 347 mm

Cat. No.	Description	Price
070103B	Unwinder for aluminium foil	N/A -

## Aluminium paper square sheet



- In square format ready to use
- Sheets separated by tissue paper
- Uniform Thickness of 30 µm

Cat. No.	Dimensions (mm)	Units/box	Price/box
075700	80 x 80	1000	N/A -
075701	100 x 100	1000	N/A -
075702	140 x 140	1000	N/A -
075703	150 x 150	1000	N/A -

## Mini aluminium rolls



- Small width aluminium rolls
- Ideal for covering bottles, erlens, etc.
- Fits into an ABS dispenser

Cat. No.	Description	Price
320047	102 mm aluminium foil roll	N/A -
320048	153 mm aluminium foil roll	N/A -

## Pre-cut aluminium foil

- Pre-cut into rounds
- For covering containers for autoclaving, incubation or storage

Cat. No.	For neck diam. (mm)	Collar height (mm)	Total unfolded diameter (mm)	Units/box	Price/box
045461	38	25	88	252	N/A -
045462	50	32	114	256	N/A -
045463	50	45	140	252	N/A -



## Aluminium containers



075704



075712

075718



075719



### Rectangular trays

Cat. No.	Capacity (ml)	L x W x H (mm)	Units/box	Price/box
075704	160	100 x 64 x 38	100	N/A -
075705	330	121 x 83 x 47	100	N/A -
075707	340	160 x 110 x 26	100	N/A -
075708	550	200 x 103 x 39	100	N/A -
075710	930	228 x 176 x 28	100	N/A -
075711	2170	316 x 215 x 43	100	N/A -

### Round caps

Cat. No.	Capacity (ml)	Ø x H (mm)	Units/box	Price/box
075712	28	64 x 13	100	N/A -
075713	115	80 x 34	100	N/A -
075714	110	99 x 25	100	N/A -
075715	110	96 x 24	100	N/A -
075716	205	127 x 26	100	N/A -
075717	280	114 x 50	100	N/A -

### Dish

Cat. No.	Capacity (ml)	Ø x H (mm)	Units/box	Price/box
075718	390	217 x 15	100	N/A -

### Weighing bucket

Cat. No.	Ø x H (mm)	Units/box	Price/box
075719	100 x 7	80	N/A -

## Weighing paper 100 x 100 mm

Cat. No.	Description	Price
074041	Weighing paper - 1000 sheets	N/A -



See our other weighing boats pages 900 to 903



## ClearLine® Top Cut Parafilm dispenser

Easy to use, to be placed directly on the Parafilm can.

- In ABS
- Easy to clean
- For 1 roll 10 cm or 2 rolls 5 cm
- Slider cutter for safe cutting
- Dimensions W x D x H: 123 x 172 x 99 mm

Cat. No.	Description	Price
257014	ClearLine® Top Cut Parafilm dispenser	N/A -





## Parafilm stretch film



006787

Stretch film especially for sealing laboratory containers.

- > Thickness: 200 µm
- > Liquid-tight, gas-permeable
- > Operating temperature: -10 °C to +60 °C
- > Supplied on a roll in a cardboard dispenser

Width (cm)	5	10	10	50
Length (m)	75	38	75	15
Cat. No.	090261	090260	090998	090999
Price	N/A -	N/A -	N/A -	N/A -

### Acrylic dispenser for Parafilm with cutter

Acrylic dispenser for one Parafilm roll.

- > Replaceable cutting blade
- > Hinged lid
- > For 1 roll 10 cm or 2 rolls 5 cm

Colours	Description	Price
006787	Acrylic dispenser for Parafilm with cutter	N/A -

### Dispenser for Parafilm with cutter

Dispenser with slider cutter and rotary film feed button.

- > Clean, neat, practical
- > For 5 and 10 cm wide rolls

Cat. No.	Description	Price
090997	Cutter dispenser for Parafilm	N/A -



## Parafilm Dispenser



For the distribution of 50 or 100 mm wide rolls.

Cat. No.	Description	Price
037770	Blue dispenser	N/A -
320049	Green dispenser	N/A -
320050	Red dispenser	N/A -
037771	Replacement cutting blades (5 units)	N/A -

## Saran Waterproof film



Waterproof film for quick closure of containers.

- > No folds, no glue
- > On a roll
- > Protects the user from toxic products, contaminants
- > Thickness: 10 µm

Cat. No.	Description	L x W (m)	Price the roll
090264	Saran standard thickness 10 µm	300 x 0.29	N/A -

## Filmpro Stretch film



Stretch film for instant closure of all containers.

- > Economical, in rolls
- > Thickness 10 µm

L x W (m)	Without ruler		With ruler	
	Cat. No.	Price the roll	Cat. No.	Price the roll
300 x 0.3	039408	N/A -	039458	N/A -
300 x 0.45	039409	N/A -	039459	N/A -

## Sealing tape for bottles



Stretch tape for reinforced sealing of laboratory bottles.

- > Waterproof
- > Good chemical and temperature resistance
- > In rolls of 35 m
- > Width: 19 mm

Colours	White	Yellow	Red	Price the roll
Cat. No.	053083	053081	053082	N/A -

## Petri dish closure tape



Stretchable adhesive tape for sealing and closing Petri dishes and microplates.

- > Limits the risk of evaporation
- > Reduces gas exchange and the risk of contamination
- > Width: 12.7 mm, length: 35 m
- > Good solvent resistance, waterproof
- > Operating temperatures: de -30 °C to +70 °C

Colours	Transparent	White	Yellow	Blue	Price the roll	
Cat. No.	053001	053002	053003	053004	053005	N/A -

## WYPALL\* L wipers

Single-use wipers made of cotton wool for light or heavy wiping of non-aggressive products such as water or oils/greases, or certain disinfectants.

### 3 ranges of wipers:

- **ESSENTIAL** range in traditional wadding, for light and general wiping (L10: single layer, L20: double layer)
- **EXTRA** range: 1 or 2 layers for light and general wiping. **AIRFLEX** wipers are more resistant and absorbent than traditional wadding
- **ULTRA** range: L30 wipers, 3 layers in **AIRFLEX** materials for top wiping of the range
- The L40 range is double re-creped for a delicate and highly absorbent wipe (contains latex)

### Centrefeed reels

Cat. No.	Wypall L	Range	Colours	Sheet (cm)	Sheets/roll	Reels/box	Compatible dispensers	Food contact	Price/box
041485	L10	-	White	19.5 x 38	800	6	E	x	N/A -
041491	L20	-	White	19.5 x 38	400	1	E	x	N/A -
002933B	L20	Extra +	Blue	18.5 x 42.5	300	6	E	-	N/A -
002986B	L20	Extra +	White	18.5 x 42.5	300	6	E	-	N/A -
040387B	L10**	Extra	White	18.5 x 38	630	6	D	x	N/A -
040433	L10**	Extra	Dark blue	18.5 x 38	630	6	D	x	N/A -
002961B	L10**	Extra	White	18.5 x 38	525	6	D	x	N/A -
002962B	L10**	Extra	Dark blue	18.5 x 38	525	6	D	x	N/A -
002935B	L10**	Extra +	White	18.5 x 38	400	6	D	x	N/A -
002960B	L10**	Extra +	Dark blue	18.5 x 38	400	6	D	x	N/A -
041490	L10	-	Blue	19.5 x 38	800	1	E	x	N/A -
041484*	L20	Essential	Blue	19.5 x 38	400	6	E	x	N/A -

\* mini reel \*\* Roll control: One-at-a-time dispensing



F

002958



E

002956B

D

002908



### Centrefeed dispensers

Cat. No.	Model	Description	Price
002908	D	White wall dispenser Roll control	N/A -
002956B	E	Cylindrical wall dispenser, white plastic	N/A -
002958	F	Rectangular wall dispenser, smoked plastic	N/A -

### Reels with conventional unwinding (lateral)

Cat. No.	Wypall L	Range	Colours	Sheet (cm)	Sheets/roll	Reels/box	Compatible dispensers	Food contact	Price/box
002944	L10	Extra	White	23.5 x 38	1500	1	A/B/C	x	N/A -
002945	L10	Extra	Blue	23.5 x 38	1500	1	A/B/C	x	N/A -
041421	L10	Extra +	Blue	23.5 x 38	1000	1	A/B/C	x	N/A -
041422	L10	Extra +	White	23.5 x 38	1000	1	A/B/C	x	N/A -
002943	L10	Extra +	Blue	33 x 38	1000	1	A/B/C	x	N/A -
041487*	L10	-	White	24 x 46	165	24	-	x	N/A -
002942B	L20	Extra +	Blue	32.5 x 38.5	500	1	A/B/C	-	N/A -
002941	L20	Extra +	Blue	23.5 x 38	500	1	A/B/C	-	N/A -
002939	L30	Ultra+	Blue	23.5 x 38	750	1	A/B/C	x	N/A -
002940B	L30	Ultra+	Blue	37 x 38	670	1	A/B/C	x	N/A -
002938	L40	-	White	31.5 x 34	750	1	A/B/C	x	N/A -

\* mini reel



A

002946

### Dispensers with conventional unwinding (lateral)

Cat. No.	Model	Description	Price
002946	A	Blue mobile dispenser with wheel and waste bag holder, all reel widths	N/A -
002947	B	Dispenser on stand, blue metal, for reels of 44 cm width and diam. 70 cm	N/A -
002948	C	Wall and stand dispenser, blue metal, for reels 44 cm width and diam. 47 cm	N/A -

### Dispenser boxes and pouches

Cat. No.	Wypall L	Range	Colours	Sheet (cm)	Sheets/Unit	Units/box	Price/box
002965B	L20	Extra	Blue	33 x 42	280/dispenser box	1	N/A -
002964	L40	-	White	30.5 x 31.8	56/pocket	18	N/A -
002904	L40	-	White	41.5 x 25	90/dispenser box	9	N/A -



B

002947



C

002948

## WYPALL\* X cloths made of HYDROKNIT\* material



Pop-up dispenser box



Dispenser box



002310

Pouch



Reel

002979

Dispensers for WYPALL\* X wipes: page 1221

### WYPALL\* X90 wipes

- > Very thick and highly absorbent, durable
- > Ideal for difficult wiping tasks

Cat. No.	Colours	Sheet (cm)	Presentation	Sheets/ box or roll	Price/ box or roll
002300	Blue	28 x 34	Pre-cut reel	450	N/A -
002301	Blue	28 x 42.5	Dispenser box	136	N/A -

### WYPALL\* ForceMax wipes

- > Very thick and durable, textile feel
- > Ideal for difficult oil and grease wiping tasks

Cat. No.	Colours	Sheet (cm)	Presentation	Sheets/ box	Price/ box
041465	Blue-grey	33.5 x 34.5	Pop-up dispenser box	480	N/A -

- > Economic wiping
- > In high-strength HYDROKNIT®
- > Excellent absorption capacity

### WYPALL\* X50 wipes

- > Made of 100% virgin fibres
- > Ideal for complex wiping tasks and lighter applications

Cat. No.	Colours	Sheet (cm)	Presentation	Sheets/ box	Price/ box
040374	White	24.9 x 34	Pre-cut reel	1100	N/A -

### WYPALL\* X60 wipes

Versatile and durable wipes for economical wiping

- > High absorption capacity
- > For wiping corners or difficult surfaces
- > Suitable for use with water and solvents.

Cat. No.	Colours	Sheet (cm)	Presentation	Sheets/ box	Reel or box/ carboard box	Price/ box
002978	Blue	31 x 42	Dispenser box	200	1	N/A -
002979	Blue	31 x 38	Pre-cut reel	500	1	N/A -
002310	Blue	36.5 x 31.5	Pouch	60	12	N/A -
002981	White	23 x 42.5	Pop-up dispenser box	126	10	N/A -
002982	White	31 x 42	Dispenser box	200	1	N/A -

### WYPALL\* X70 wipes

- > Highly absorbent
- > For fast and efficient wiping of oil, grease, dirt and solvents
- > Ideal for maintenance, easy to use and economical: just wring them out and reuse them

Cat. No.	Colours	Sheet (cm)	Presentation	Sheets/ box	Reel or box/ carboard box	Price/ box
002973	White	37.5 x 42	Dispenser box	300	1	N/A -
002302	White	31 x 32	Pouch	76	12	N/A -
002303	White	42.7 x 28.2	Dispenser box	200	1	N/A -
002304	Blue	34 x 31.5	Reel	870	1	N/A -
002305	Blue	42.5 x 23	Pop-up dispenser box	100	10	N/A -

### WYPALL\* X80 wipes

- > Ideal for wiping grease, oil and stubborn dirt
- > Can be used with water or solvents: rinse for reuse
- > Available in various convenient and efficient distribution systems (in roll or sheets)

Cat. No.	Colours	Sheet (cm)	Presentation	Sheets/ box or roll	Reel or box/ carboard box	Price/ box
002968B	Blue	34 x 31.5	Reel	475	1	N/A -
002967B	Blue	42.7 x 28.2	Dispenser box	160	1	N/A -
041438	White	31 x 42	Dispenser box	160	1	N/A -
002969B	Blue	42.7 x 21.2	Pop-up dispenser box	80	10	N/A -
002970	White	31.5 x 34	Reel	475	1	N/A -
002971	White	31 x 32	Pouch	50	4	N/A -

## Folded hand towels



- > 2 ply
- > In heavy-duty DESL quality or in a smooth version

Cat. No.	Folding	Quality	Number of sheets	Sheet L x W (cm)	Packs or rolls/ carboard box	Price/ box
475038	In Z	DESL	150	21.6 x 23	30	N/A -
475039	In W	DESL	100	21.6 x 34	27	N/A -
475040	In W	Smooth	188	21.3 x 31	20	N/A -

### Dispenser for folded towels

Cat. No.	Description	Price
475049	Handy dispenser in white ABS	N/A -



## Embossed paper towels in industrial reels

- 100% pure cellulose wadding
- DESL quality: ultra-resistant paper, both wet and dry
- Embossing 40 pt/cm<sup>2</sup>
- Soft paper, does not separate or lint
- Environmentally friendly design and use: more absorbent and durable than a standard industrial wiper
- Optimised logistics and raw material from sustainably managed forests
- Made in France
- Food contact compatible



Cat. No.	Model	Unwinding	Number of folds	Number of sheets	Width (cm)	Perforations (cm)	Roll diameter (cm)	Compatible dispenser	Rolls/box	Price/box
475024	White	Lateral*	2	1000	22.6	30	26	475045 475046 475047	2	N/A -
475025	White	Lateral*	2	1500	22.6	30	30		2	N/A -
475026B	White	Lateral*	2	1500	36.5	30	30		1	N/A -
475027	White	Lateral*	2	1000	22.6	23	26		2	N/A -
475028	White	Lateral*	2	1500	22.6	23	30	475047	2	N/A -
475030	White	Lateral*	2	800	22.6	23	24		2	N/A -
475031	White	Central	2	450	19.4	30	19	475048	6	N/A -
475033	White	Central	2	450	18.1	23	19		6	N/A -
475034	White	Central	2	450	19.4	23	19		6	N/A -
002935C	White	Central	2	450	19.4	35	19		6	N/A -
475032	White	Central	2	200	19.4	25	13	476068, 475048	9	N/A -

\* central unwinding possible with dispenser 475047 thanks to the tear-off central mandrel.

## Paper towels on a roll

- Compact: economical and practical
- DESL quality: ultra-resistant paper, both wet and dry
- 2 ply

Cat. No.	Number of sheets	Sheet L x W (cm)	Roll Ø (cm)	Packs or rolls/ cardboard box	Price/box
475050	500	19.4 X 23	19	6	N/A -
475036B	50	23 X 22.7	10	32	N/A -
475035	300	22.5 X 23	15	10	N/A -
155019	64	23 X 24	-	2 X 12	N/A -



## Dispensers for reel wipers

Side or central unwinding reels: For central unwinding use, the pre-cut cardboard tube in the center of the reel must first be removed.

Cat. No.	Model	Reels: width Up to	Reels: Ø up to	Price
475048	Wall mounted / sheet central unwinding	19.4 cm	20 cm	N/A -
475047	Wall mounted / central reel	31 cm	32 cm	N/A -
476068	Wall mounted / central reel	19.4 cm	13 cm	N/A -
475045	Tripod / lateral reel	45 cm	-	N/A -
475046	Wall / lateral feed	30 cm	-	N/A -



## Dispensers for paper rolls

- For lateral unwinding reels with a maximum diameter of 350 mm and a width of 320 mm
- In lacquered steel or stainless steel

Cat. No.	Type	Material	Dimensions L x D x H (mm)	Price
022400	Wall-mounted*	Stainless steel	392 x 275 x 345	N/A -
022401	Wall-mounted*	Lacquered steel	392 x 275 x 345	N/A -
022402	On stand	Lacquered steel	480 x 450 x 810	N/A -
022403	On stand	Stainless steel	392 x 450 x 810	N/A -

\* fastener supplied



022402



022403



022400



022401

## AutoCut® Hand Towel Dispenser



- Maintenance and installation
- Key security on both sides
- Visual check of remaining paper
- Universal wall mounting plate
- Block can be removed in 20 seconds
- Economy and waste reduction
- One-at-a-time dispensing
- Automatic cutting system
- Hygienic
- Contactless dispensing
- Compatibility
- Compatible with rolls Cat. No. 475054

Cat. No.	Description	Price
475055	AutoCut® Hand Towel Dispenser	N/A -



### Compatible hand towel rolls

- White 2-ply cellulose wadding
- DESL embossing 40 pts/cm<sup>2</sup>
- Go Green: paper from eco-managed forests, French manufacture
- Ø (new roll): 190 mm, width: 196 mm - total length: 150 m

Cat. No.	Description	Price/6 units
475054	Hand towel rolls for AutoCut® hand towel dispenser	N/A -

## ECOTEX\* wipers



- ECOTEX® all purpose white wipers, non-woven and high performance, available in bag, roll or box
- One-at-a-time dispensing boxes
- 5 qualities of ECOTEX® wipers:
  - Top: robust, very strong and absorbent; for heavy duty wiping
  - Standard: absorbent and strong
  - Basic: absorbent and strong; for everyday wiping
  - Soft: soft and very absorbent; for delicate wiping
  - Top and MUST Top: robust, very strong

Cat. No.	Description	Dim. paper L x W (cm)	Packaging unit	Price
476066	Bag of folded white Soft wipers	35 x 30	12 bags with 60 wipers	N/A -
476090	Bag of folded white Soft wipers	35 x 30	12 bags with 50 wipers	N/A -
002938C	Soft wipe roll *	35 x 35	1 roll of 500 wipers	N/A -
002914C	EXTRABOX box of Standard wipers	35 x 50	1 Boxes of 100 wipers	N/A -
002970C	Top wiper roll *	35 x 35	1 roll of 500 wipers	N/A -
002971C	Top wipers	35 x 35	10 bags with 50 wipers	N/A -
002967C	ECOBX of top wipers, blue	23 x 50	1 Boxes of 100 wipers	N/A -
476064	EXTRABOX of Must Top wipers, tangled, white	50 x 35	5 Boxes of 100 wipers	N/A -

\* Compatible with dispensers Cat. No. 475045 and 475046

## KLEENEX® cellulose wadding hand towels

Hand towels in single sheets, 2 or 3 folds.

- High absorption capacity
- Soft and durable
- Entangled
- More absorbent, thicker, resistant
- More economical
- Three qualities: Kleenex® Premier (thick and very strong) and Kleenex® Ultra (soft and comfortable), Scott® (blue, strong, economical wadding)



Cat. No.	Model	Wipe (cm)	Number of folds	Sheets/package	Packages/box	Price/box
002929B	Kleenex® Ultra	21.5 x 31.8	3	96	15	N/A -
002307	Kleenex® Ultra	21.5 x 31.5	2	124	15	N/A -
002915	Kleenex® Premier	21.5 x 41.5	2	94	30	N/A -

### Wall dispenser

Cat. No.	Description	Price
002930	Wall mounted towel dispenser (2 pack capacity)	N/A -

## Kleenex Ultra Soft Folded Hand Towels



- In a POP UP 260 x 225 mm waterproof dispenser box
- 70 folded hand towels
- Sheet-by-sheet distribution
- Ultra resistant, made of cotton wool and latex

Cat. No.	Description	Price 18 boxes
039025B	Kleenex Ultra Soft Hand Towels - box of 70	N/A -

## SCOTT removable hand towels



- Hand towels in white interleaved format
- Composition:
  - virgin fibres: 30 %
  - recycled fibres: 70 %
- Airflex technology

Cat. No.	Wipe (cm)	Sheets/package	Packages/box	Price/box
040358	21 x 21.50	300	15	N/A -

## Scott® Xtra Hand Towels - Blue and White

- Packaging: plastic
- Package thickness: 20 cm



Cat. No.	Width Wipes (cm)	Length Towel (cm)	Colours	Number of towels	Packages/ box	Price/ package
040341	20	31.5	Blue	240	15	N/A -
040343	20	31.5	Blanc	240	15	N/A -

## Ko-Ton wiper

- Soft multi-functional wiper
- Easily absorbs water, oil and ink
- Quickly removes all types of liquids
- Very low linting
- Low fibre release
- Silicone free
- Sheet: 340 x 320 mm



Cat. No.	Description	Dimensions W x H (mm)	Units/ box	Price/ box
316050	Ko-Ton cloths	340 x 320	100	N/A -

## SCOTT Slimfold hand towels and dispenser



- Hand towels in single sheet with 1 fold
- Composition: virgin fibres: 50 %, recy cled fibres: 50 %

Cat. No.	Sheet (cm)	Number of folds	Sheets/ package	Packages/ box	Price/ box
040356	29.50 x 19	1	110	16	N/A -

Dispenser - Dispenser thickness: 5 cm.

Cat. No.	Description	Price
040357B	SCOTT Slimfold Dispenser	N/A -

## SCOTT®Tissues

- Economical tissues
- 2 ply
- 100% virgin fibre
- Sheets 185 x 215 mm
- In a one-at-a-time dispenser box
- With end of box indicator



Cat. No.	Description	No. of Sheets/ box	Boxes/ box	Price/ box
002989	Scott®Tissues	100	21	N/A -

## Cleanroom wipers Q+ range

- Dry wipers for controlled environment ISO 4/5 or 6/7 cleanrooms, double packed
- Made from virgin fibre; no traces of silicone, amides or DOP
- Very low levels of ions and extractables
- Different cuts
- Laser (no fibre loss), ultrasonic (soft edges, no scratching) or standard (knife)
- Material
- Poly-Neat P1: 100% continuous filament knitted polyester, cross pattern
- Poly-Neat 2P3: 100% continuous filament polyester, 2 layers bonded with ultrasound for better absorption
- Wu-Neat Z6: microfiber technology with tight weave for durability
- SKM 609: 55% cellulose, 45% polyester, low fibre loss and soft to the touch, high absorbency

### For ISO 4/5 environment

Cat. No.	Type	Weight (g/m²)	Dim. (cm)	Cutting	Sheets/ bag	Bags/ box	Price/ box
133000	Poly-neat P1	140	23 x 23	Laser	150	12	N/A -
133002	Poly-neat P1	140	31 x 31	Laser	100	12	N/A -
133004	Poly-Neat 2P3	150	23 x 23	Ultrasound	100	12	N/A -
133006	Poly-Neat 2P3	150	31 x 31	Ultrasound	100	10	N/A -
133008	Wu-Neat Z6	120	23 x 23	Laser	100	12	N/A -
133010	Wu-Neat Z6	120	31 x 31	Laser	100	10	N/A -

### For ISO 6/7 environment

Cat. No.	Type	Weight (g/m²)	Dim. (cm)	Cutting	Sheets/ bag	Bags/ box	Price/ box
133001	Poly-neat P1	140	23 x 23	Laser	150	12	N/A -
133003	Poly-neat P1	140	31 x 31	Laser	100	12	N/A -
133005	Poly-Neat 2P3	150	23 x 23	Ultrasound	100	12	N/A -
133007	Poly-Neat 2P3	150	31 x 31	Ultrasound	100	10	N/A -
133009	Wu-Neat Z6	120	23 x 23	Laser	100	12	N/A -
133011	Wu-Neat Z6	120	31 x 31	Laser	100	10	N/A -
133012	SKM 609	68	23 x 23	Standard	150	20	N/A -
133013	SKM 609	68	31 x 31	Standard	150	20	N/A -





## Extra soft tissues



Made of pure cellulose wadding from ecologically managed forests

- White smooth tissues, 2-ply, 15 g/m<sup>2</sup>
- Made in France

Cat. No.	Description	Number of sheets/box	Boxes/box	Price/box
475023	Extra soft tissue box 19.4 x 20 cm	100	40	N/A -

## KLEENEX®Tissues



High quality tissues, combining softness and absorption.

- 2 ply
- 100% virgin fibre
- In a one-at-a-time dispenser box
- 4 End of box indicator

Cat. No.	Description	No. of Sheets/box	Boxes/box	Price/box
002987B	Kleenex®Tissues 210 x 186 mm	100	21	N/A -
002988	Kleenex®Square box 211 x 210 mm	90	12	N/A -

## Turbo Towels wipes



- Cleaning, disinfecting and degreasing wipes
- Compatible with TP1, TP2, human use and surfaces (according to the Biocide Directive)
- One side is slightly abrasive, perfect for scraping or blotting; the other is soft and absorbent for wiping
- Individual and practical distribution in buckets
- Sheet L x W: 33 x 30 cm

Cat. No.	Description	Packaging unit	Price
040405C	Turbo Towels	1 Bucket of 70 wipes	N/A -

## Wypall cleaning wipes



040406



040405

Kimberly-Clark Professional

- Pre-saturated and solvent-free wipes
- One-at-a-time controlled distribution
- Patented triple-layer material and advanced formula
- Prevents skin dryness
- Economic
- Colour: green
- Number of folds: 1
- To be used instead of a gel or soap
- Removes grease, ink, paint, quickly
- For hands or devices

Cat. No.	Description	Dim. (cm)	Packaging unit	Price
040406	Metal dispenser box of 50 wipes	27 x 27	Box of 50	N/A -
040405	Bucket of 90 wipes	27 x 27	Bucket of 90	N/A -

## WYPALL\* x80 heavy-duty cloths



- Offers good absorption capacity and speed, high resistance for a better duration of use
- Colour coding to differentiate tasks and reduce the risk of cross-contamination
- L x W: 35 x 42 cm
- Protected by a plastic bag until used
- Can be rinsed and reused
- One-at-a-time dispensing system allows consumption control (reduced running costs)

Colours	Blue	Green	Yellow	Red	Units/box	Price/box
Cat. No.	002909	002910	002911	002912	25	N/A -

## Wypall microfibre cloths

- Reduce the risk of cross-contamination
- Soft texture for cleaning glassware
- Can be washed up to 300 times
- Fast and efficient cleaning
- Can be used wet or dry
- Absorb up to 8 times their weight in liquid
- Removes and retains dirt on all surfaces



Colours	Blue	Green	Red	Units/box	Price/box
Cat. No.	040335	040336	040337	6	N/A -

## ECOTEX cloths

- Two ranges available:
  - Microfiber: dust and particles
  - Multitowel: Classic Absorbent Wipes



Range	L x W (cm)	Blue	Green	Yellow	Red	Sheets/bags	Price/bag
Microfiber	40 x 40	040335C	040336C	040334C	040337C	5	N/A -
Multitowel	50 x 35	002909C	002910C	002911C	002912C	25	N/A -

## HORECA cloths

- Certified for food contact
- Dimensions (cm): 40 x 35
- Antibacterial action
- 5 Colours available: no cross-contamination
- Efficient, practical, economical wiping
- Reusable and washable
- Packaged in a bag



Colours	White	Pink	Units/box	Price/box
Cat. No.	475056	475057	8 x 25	N/A -

## Vegetable sponges made of cellulose



- For wiping on all types of surfaces
- Can be decontaminated with chlorinated water
- Rinse before the first use and after each use

Cat. No.	Dimensions (mm)	Units/box	Price/box
155024	127 x 89 x 10	10	N/A -
155026	135 x 90 x 10	10	N/A -

## Rechargeable mini hoover



- Powerful cordless hoover, Li-Ion battery operation
- Easy to clean permanent dust filter
- Additional 12 volt power cord for connection to the cigarette lighter
- Powerful suction to pick up both dirt and liquid
- Crevice nozzle with push-on-brush
- Charging visual indicator
- Rubber nozzle to pick up liquid
- Integrated overcharge and deep-discharge protection
- Wall bracket with power base

Cat. No.	Description	Price
067230	Rechargeable Vacuum Cleaner	N/A -
067226B	Spare filter for table top vacuum cleaner	N/A -

## KIMTECH Science\* wipers

- Chemical resistant, suitable for use with chemicals and solvents
- Ideal for wiping small amounts of liquid, cleaning pipettes and microscope slides
- Low linting level, ideal for delicate wiping
- One-at-a-time dispensing
- 100% virgin fibres, better absorbency and softer feel

Cat. No.	L x W Sheet (cm)	L x W x H box (cm)	No. folds	Sheets/boxes	Boxes/box	Price/box
002901	30.4 x 30.4	30.7 x 11.9 x 9	1	196	15	N/A -
002907	11.4 x 21.3	11.7 x 12.1 x 7.5	1	280	30	N/A -
040490	20 x 21	23 x 11.5 x 5.2	2	100	24	N/A -
040490A	20 x 21	23 x 11.5 x 5.2	2	100	1	N/A -



## Lens cleaning tissue



- ▶ Made of Japanese paper, for wiping lenses
- ▶ Lint free
- ▶ Sold in packs of 25 tissues

Cat. No.	Sheet (mm)	Units/box	Price/box
074042	95 X 135	25 X 25	N/A -
074089	100 X 150	625	N/A -
074090	200 X 300	100	N/A -
074091	460 X 570	500	N/A -

## Whatman Optical paper



High quality paper for cleaning optical surfaces and lenses. Does not contain any chemical agents, silicone or special additives.

- ▶ Very soft, does not scratch
- ▶ Very pure, free of additives
- ▶ Highly absorbent for grease and moisture removal

Cat. No.	Dimensions (mm)	Packaging	Price
036445	100 X 150	25 notebooks of 25 sheets	N/A -
036531	200 X 300	100	N/A -
036532	460 X 570	500	N/A -

## ECO lens cleaning wipes



Cat. No.	Dimensions (mm)	Packaging	Price/box
068885	95 X 135	25 bags of 25 sheets	N/A -
068886	190 X 135	500 sheets	N/A -
068887	190 X 270	500 sheets	N/A -
068888	380 X 540	500 sheets	N/A -

## MN13 Optical paper



- ▶ Fine, soft, lint-free
- ▶ For cleaning glass lens
- ▶ Dimensions: 36 x 48 cm

Cat. No.	Description	Price/500 units
910666	MN 13 Optical Paper	N/A -

## Gaz Net



- ▶ Dry, neutral gas compressed to 6 kg/cm<sup>2</sup>
- ▶ Dusting and drying of all materials and surfaces
- ▶ Non-flammable, non-toxic
- ▶ Compatible with electronic equipment
- ▶ In aerosol

Cat. No.	Volume (ml)	Price
280016	650	N/A -

## Flat screen cleaning kit



- ▶ Cleaning and degreasing gel + microfiber cloth

Cat. No.	Volume (ml)	Price
280013	75	N/A -

## Optical cleaning



- ▶ 2 formats: wipes or cleaning lotion for mineral and organic glass
- ▶ Does not leave a trace

Cat. No.	Pack.	Price
280003	1000 wipes	N/A -
280004	Lotion 50 ml	N/A -

## Cleaning brush



- ▶ Antistatic
- ▶ Size M: 115 mm

Cat. No.	Description	Price
146998	Cleaning brush	N/A -



## Stainless steel dispensers for bag rolls



Cat. No.	Mandrel	Max width Of the roll (cm)	Max Ø roll (mm)	Dimensions L x D x H (mm)	Price
022404	Without	47	-	480 x 150 x 150	N/A -
022405	With	90	300	1200 x 300 x 360	N/A -

## Dispensers for aluminium or stretch film



- > In stainless steel
- > Wall mounting: screws and dowels supplied
- > With cutting strip

Cat. No.	Type	Axis	For rolls of width (cm)	Dimensions L x D x H (mm)	Price
022406	Mural	Stainless steel	50	540 x 110 x 110	N/A -
022407	To put down (suction pads)	Stainless steel	50	540 x 110 x 110	N/A -
022408	Wall mounting or free standing (silicone pads)	ABS	55	345 x 120 x 95	N/A -

## Storage rack for Kimwipes and Kimtech boxes

- > Transparent acrylic holder
- > For storing a Kimwipes and Kimtech dispenser box
- > Can be fixed to the wall with adhesive (small model) or screws (large model)

Cat. No.	Description	L x H x H (mm)	Price
037751	Stand for small box	122 x 117 x 77	N/A -
037752	Stand for big box	318 x 124 x 91	N/A -



## Glove box holders



- > With Microban® antimicrobial coating
- > Made of impact-resistant polystyrene
- > Delivered in three modules, to be used alone or in groups of three
- > Horizontal or vertical
- > Modules dimensions: 254 x 156 x 97 mm

Cat. No.	Description	Price
037976	Blue holder with Microban® antimicrobial coating	N/A -
320731	White holder with Microban® antimicrobial coating	N/A -

## Acrylic holder for glove boxes



- > Transparent acrylic holder
- > Facilitates the distribution of gloves
- > Can be mounted on a wall with screws (included)

Cat. No.	Capacity	L x H x D (mm)	Price
037646	1 box	141 x 110 x 260	N/A -
037647	2 boxes	295 x 110 x 260	N/A -
037648	3 boxes	295 x 110 x 385	N/A -

## Storage rack for glove boxes

- > Epoxy coated steel holder
- > Facilitates the distribution of gloves
- > Can be mounted on a wall with screws (included)

Cat. No.	Capacity	L x H x H (mm)	Price
037644	1 box	140 x 108 x 208	N/A -
037645	3 boxes	250 x 108 x 454	N/A -



## Glove box holder



- Suitable for 4 boxes of different sizes
- Easy to clean
- Wall or door mounting
- Dimensions: 152 x 762 x 76 mm

Cat. No.	Description	Price
320115	Holder for 4 boxes of gloves	N/A -

## Rack for storage of glove boxes



- Epoxy coated
- Fits horizontally or vertically
- Supplied with fixing screws
- Designed for the leading glove brands
- Dimensions of glove boxes (W x D x H): 240 x 140 x 90 mm

Cat. No.	Description	Price
141376	Rack for glove box	N/A -



See also: Tape dispensers page 1235 and dispensers for PPE page 1227

## ClearLine® Permanent Markers



- Ink resistant to -200 °C
  - Water and rub resistant ink
  - Fast drying on the substrate
  - Xylene and toluene free ink
- Line width:  
 - double tip: 0.6 mm and 1.5 mm  
 - medium tip: 1.0 mm  
 - super fine tip: 0.4 mm



## Felt Pens

Colours	Medium tip		Super fine tip	
	Cat. No.	Price	Cat. No.	Price
Red	929208	N/A -	929204	N/A -
Blue	929209	N/A -	929205	N/A -
Green	929210	N/A -	929206	N/A -
Black	929211	N/A -	929207	N/A -
Yellow	929218	N/A -	929214	N/A -
Orange	929219	N/A -	929215	N/A -
Violet	929220	N/A -	929216	N/A -
Brown	929221	N/A -	929217	N/A -

## Cases (4 colours: red, blue, green and black)

Cat. No.	Description	Price
929212	Set of 4 markers with extra fine tip	N/A -
929213	Set of 4 markers with medium tip	N/A -

## White marker



- For smooth, non-porous, dark or transparent surfaces
- Aluminium body
- Permanent pigment ink
- Odourless, lacquered and opaque
- Water resistant

Cat. No.	Description	Price
711868	White marker 2-4 mm	N/A -
711869	White marker 1-2 mm	N/A -

# MARKER PENS

## Sterile marker



- Blue ink marker
- Sterile, individually wrapped
- Two types of tips: fine or standard

Cat. No.	Description	Price
972443	Sterile marker standard tip	N/A -

## Ultra fine laboratory marker

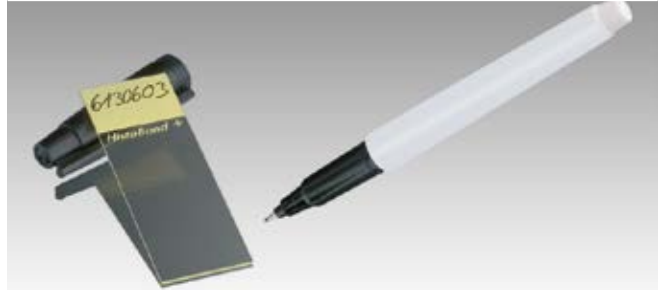

- Ultra-fine tip
- Indelible
- For plastics, glass
- Black ink
- Good chemical resistance
- Good service life

Cat. No.	Description	Price
140604	Ultra fine black marker	N/A -

## Hydrophobic markers with coloured lines

- Hydrophobic markers
- Fast drying
- Suitable for frozen and paraffin surfaces
- Detergent resistant (Tween 20, Triton X100)

Red	Orange	Green	Blue	Yellow	Violet	Price
594000	594001	594002	594003	594004	594005	N/A -



## Double-tip permanent markers

Permanent double tip markers for a fine and precise line. Can be used on any surface (glass, metal, porcelain, plastic, etc.)

- Double-tip: fine and ultra-fine
- Water resistant ink, solvent washable
- 8 assorted colours

Cat. No.	Description	Price pack of 8
320093	Permanent markers (set of 8 assorted colours)	N/A -





# MARKER PENS

## Lab Marker and Marker II Superfrost



### ▶ Lab Marker Features

- ▶ Permanent ink
- ▶ For writing on glass, plastic, metal or porcelain
- ▶ Red, blue, green or black

### ▶ Marker II Superfrost Features

- ▶ Special for histology and cytology
- ▶ Permanent ink resistant to solvents such as xylene, alcohol, acetone, formalin
- ▶ Red or black
- ▶ Not resistant to chloroform

### Lab Marker fine tip

Colours	Black	Blue	Green	Red	Price
Cat. No.	686004	686005	686006	686007	N/A -

### Marker II Superfrost special histology and cytology

Cat. No.	Description	Price
686009	Marker II Superfrost red	N/A -

## Penlight



### ▶ Supplied with batteries

### ▶ Ignition switch

Cat. No.	Description	Price
711922	Penlight with batteries	N/A -

## Fluorescent marker



### ▶ Special laboratory

### ▶ Interchangeable fine tip for autoradiography

### ▶ Contains enough phosphor to be visible at different wavelengths

Cat. No.	Description	Price
053397	Fluorescent marker with 4 tips	N/A -

## Membrane markers

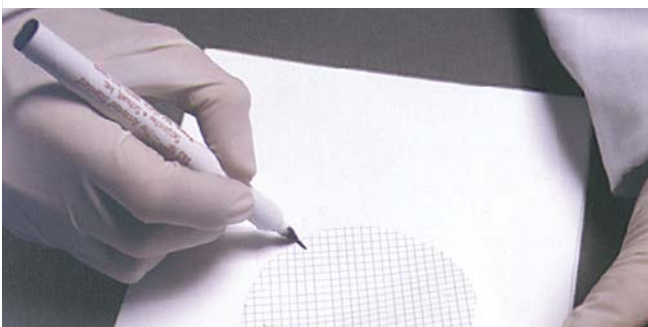

### ▶ Xylene-based

### ▶ Permanent writing

### ▶ For nitrocellulose and nylon membranes

### ▶ Ideal for orientation of membranes in different types of transfers

Cat. No.	Description	Units/box	Price / box
034982	Membrane markers	10	N/A -

## Cryomarkers



Pack of 4 cryomarkers specially designed for writing on cryotubes, freezing boxes and cryogenic media.

Cat. No.	Description	Price
028123	Pack of 4 cryomarkers in assorted colours (green, blue, red, black)	N/A -
028124	Pack of 4 black cryomarkers	N/A -

## Cryopen markers



Special low temperature fine tip marker, resistant to xylene and alcohol. Erased with ethanol

Cat. No.	Description	Price
055036	Pack of 4 cryopens (green, red, blue, black)	N/A -

## Safety laboratory notebooks

3 formats: A4, A5 and A4 «oversized» to keep protocol sheets written on full A4 paper.

- For the conservation of data from the experiments
- Fully hand-sewn and paginated
- With writing in English and French
- Location for signature, date
- Hydrophobic hard cover

Cat. No.	Description	Price
440300	96 page A4 notebook with 5 mm grid	N/A -
440301	240 page A4 notebook with 5 mm grid	N/A -
440302	168 page A4 oversized notebook with 5 mm grid	N/A -
440303	72 page A5 notebook with 5 mm grid	N/A -



Your personalised laboratory notebooks, printed with your laboratory's name? Consult us!

## Laboratory notebooks

Sewn notebooks with permanent squared or lined sheets

- 96 numbered pages
- Non-wettable polyethylene cover
- With space for user's signature, name and date
- For recording data and protocols in the laboratory

Cat. No.	Description	Price
029367	Laboratory notebook, lined paper, A4 size (dark red cover)	N/A -
029368	Laboratory notebook, squared paper, A4 size (dark green cover)	N/A -



## Sterifold Pivoting Pockets

To display and make accessible all your information on workstations, machines, in laboratories, pharmaceutical industry.

The film (PVC 11/100) of Sterifold Pockets has been treated with the antimicrobial additive Agion, using silver ion technology.

When handled, Sterifold Pockets will release silver ions with antimicrobial properties whenever harmful micro-organisms appear on the door surface. NB: For optimal antimicrobial protection, Sterifold Pockets should be replaced every 2 years.

### Sterifold Pivoting Pockets

- With metal pivots
- Format 385 x 245 x 50 mm
- Top pocket opening
- Black
- Packed in bags of 10 to protect them from moisture and dust, neutral cardboard

Cat. No.	Description	Price 10 units
067922	Anti-microbial pockets A4	N/A -
067925	Anti-microbial stainless steel pivoting pockets A4	N/A -



### Sterifold 10-pocket wall set

- Light grey wall mounted element with 4 pluggers to hold the pockets in place
- A4 size, stainless steel version
- 10 Sterifold antibacterial pivoting pockets
- 5 clip-on index tabs (neutral/color inserts)
- Assembly materials screws, bolts and spacer
- The pockets are packaged in bags to protect them from humidity and dust

Cat. No.	Description	Price
067920	Stainless steel wall kit with 10 anti-microbial A4 pockets	N/A -
067923	Empty stainless steel wall unit for 10 pockets	N/A -
067925	A4 anti-microbial stainless steel pivoting pockets (10 units)	N/A -



### Sterifold 10-pocket desk

- Light grey desk with 4 pluggers to hold the pockets in place
- 5 clip-on index tabs (neutral/color inserts)
- Packed per 1, plain carton, size 380 x 33 x 240 mm
- The pockets are packaged in bags to protect them from humidity and dust
- Format A4
- 10 Sterifold antibacterial pivoting pockets
- The desk can be expanded to 20 or 30 pockets by adding 1 or 2 Sterifold wall-mounted units (067920)
- Wall mounting possible thanks to the perforations on the back of the base

Cat. No.	Description	Price
067921	Desk with 10 anti-microbial A4 pockets	N/A -
067924	Stand for desk, 10 to 30 pockets	N/A -

To compose a stainless steel desk kit you need:

- 067924: Stainless steel desk stand
- 067923: empty stainless steel wall element
- 067925: 10 stainless steel pockets

## Repositionable display system

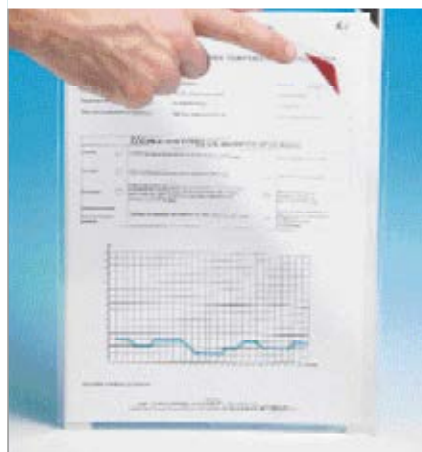

- Format A4
- Repositionable (can be removed and reattached)
- Display your self-checks and documents in strategic locations
- Up to 10 A4 sheets stored

Cat. No.	Description	Units/box	Format	Price/box
853112	Magnetic closure pocket with adhesive on the back	5	A4	N/A -

## Writable adhesive tapes



- Residue-free, solvent-resistant rubber resin adhesive
- Can be used from - 80 °C to + 154 °C
- Autoclavable, resistant to gamma irradiation (from 13 to 45 kGy)

Length (m)	13			36			54		
	13	19	25	13	19	25	13	19	25
White	947677	947678	947679	947687	947688	947689	947705	947706	947707
Red	-	-	-	947690	947691	947692	-	-	-
Yellow	947680	947681	947683	947693	947694	947695	-	-	-
Green	947684	947685	947686	947696	947697	947698	-	-	-
Blue	-	-	-	947699	947700	947701	-	-	-
Orange	-	-	-	947702	947703	947704	-	-	-
Units/box	6	4	3	6	4	3	6	4	3
Price/box	N/A -	N/A -	N/A -	N/A -	N/A -	N/A -	N/A -	N/A -	N/A -



## ClearLine® adhesive tapes

Coloured rolls of adhesive tape designed for the laboratory

- Robust, water, oil and acid resistant
- Can be used in freezer at - 80 °C and in autoclave for 15 minutes at + 121 °C
- For marking with pen, pencil or permanent marker
- Sticks to most surfaces: glass, plastic and metals
- Easy and clean to remove
- Available in 2 lengths (12 m and 55 m) and 3 widths (13, 19 and 25 mm)

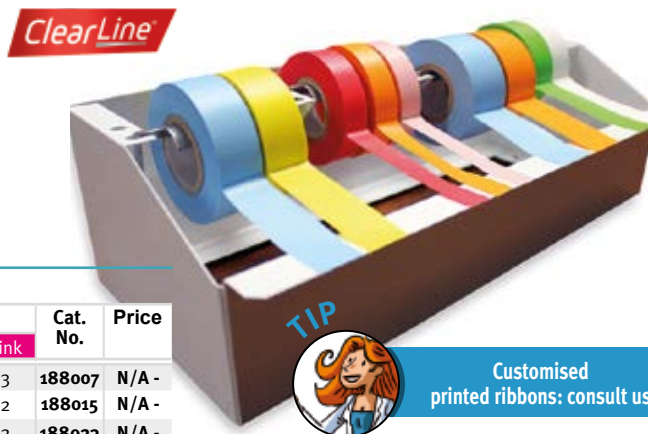

Customised printed ribbons: consult us

### Rainbow Packs: assorted colours

Description	Contents (in rolls)							Cat. No.	Price
	White	Yellow	Red	Orange	Green	Blue	Pink		
Rainbow Pack: 24 rolls 12 m x 13 mm	5	4	3	3	3	3	3	188007	N/A -
Rainbow Pack: 16 rolls 12 m x 19 mm	4	2	2	2	2	2	2	188015	N/A -
Rainbow Pack: 12 rolls 12 m x 25 mm	2	2	2	1	2	1	2	188023	N/A -

### ClearLine® adhesive tape length 12 m

Width (mm)	13		19		25	
	6	1	4	1	3	1
White	188000	188000A	188008	188008A	188016	188016A
Yellow	188001	188001A	188009	188009A	188017	188017A
Green	188002	188002A	188010	188010A	188018	188018A
Red	188003	188003A	188011	188011A	188019	188019A
Orange	188004	188004A	188012	188012A	188020	188020A
Blue	188005	188005A	188013	188013A	188021	188021A
Pink	188006	188006A	188014	188014A	188022	188022A
Turquoise	188048	188048A	188050	188050A	188052	188052A
Fuchsia	188049	188049A	188051	188051A	188053	188053A
Ochre	188061	188061A	188071	188071A	188081	188081A
Salmon	188062	188062A	188072	188072A	188082	188082A
Copper	188063	188063A	188073	188073A	188083	188083A
Violet	188064	188064A	188074	188074A	188084	188084A
Lavender	188065	188065A	188075	188075A	188085	188085A
Grey	188066	188066A	188076	188076A	188086	188086A
Lime	188067	188067A	188077	188077A	188087	188087A
Chartreuse green	188068	188068A	188078	188078A	188088	188088A
Gold	188069	188069A	188079	188079A	188089	188089A
Silver	188070	188070A	188080	188080A	188090	188090A
Price	N/A -	N/A -	N/A -	N/A -	N/A -	N/A -

### ClearLine® adhesive tape length 55 m

Width (mm)	13		19		25	
	6	1	4	1	3	1
White	188024	188024A	188031	188031A	188038	188038A
Yellow	188025	188025A	188032	188032A	188039	188039A
Green	188026	188026A	188033	188033A	188040	188040A
Red	188027	188027A	188034	188034A	188041	188041A
Orange	188028	188028A	188035	188035A	188042	188042A
Blue	188029	188029A	188036	188036A	188043	188043A
Pink	188030	188030A	188037	188037A	188044	188044A
Turquoise	188054	188054A	188056	188056A	188058	188058A
Fuchsia	188055	188055A	188057	188057A	188059	188059A
Ochre	188091	188091A	188101	188101A	188111	188111A
Salmon	188092	188092A	188102	188102A	188112	188112A
Copper	188093	188093A	188103	188103A	188113	188113A
Violet	188094	188094A	188104	188104A	188114	188114A
Lavender	188095	188095A	188105	188105A	188115	188115A
Grey	188096	188096A	188106	188106A	188116	188116A
Lime	188097	188097A	188107	188107A	188117	188117A
Chartreuse green	188098	188098A	188108	188108A	188118	188118A
Gold	188099	188099A	188109	188109A	188119	188119A
Silver	188100	188100A	188110	188110A	188120	188120A
Price	N/A -	N/A -	N/A -	N/A -	N/A -	N/A -

### ClearLine® roll dispensers

Cat. No.	Description	Price
188045	Multi-roll dispenser for 55 m adhesive tapes, 4 compartments of 60 mm	N/A -
188046	Multi-roll dispenser for 12 m adhesive tapes, 4 compartments of 65 mm	N/A -
188047	ClearLine® Individual dispenser for 12 m adhesive tapes	N/A -
188060	ClearLine® Individual dispenser for 12 and 55 m adhesive tapes	N/A -



## Adhesive tape - 196 °C to + 288 °C

- Extreme temperature resistant tape
- Textured surface
- Ideal for liquid nitrogen freezing or marking of products for sterilisation, for oven or incubator

Cat. No.	Width x Length	Price the roll
140275	12.7 mm x 7.6 m	N/A -
140276	19 mm x 7.6 m	N/A -
140277	25 mm x 7.6 m	N/A -



## Time Tape Coloured adhesive tapes



Coloured adhesive tapes specially designed for laboratory use. The economical rainbow pack: always the right colour at hand! Length: 12 m. 3 widths:

- 13 mm (colours: 5 white, 4 yellow, 3 green, 3 pink, 3 red, 3 orange and 3 blue);
- 19 mm (colours: 4 white, 2 yellow, 2 blue, 2 green, 2 orange, 2 red and 2 pink);
- 25 mm (colours: 2 white, 2 yellow, 2 green, 2 blue, 2 red, 1 pink and 1 orange).

► **Autoclavable (+ 130 °C)**

► **Can be used in the freezer (-50 °C), adheres perfectly at 0 °C**

► **Suitable for use in ovens and furnaces**

► **Can be glued and unglued without leaving a trace**

► **Marking with pencil, ink, felt-tip pen**

Cat. No.	Description	Price
140260	Set of 24 rolls 13 mm x 12 m	N/A -
140261	Set of 16 rolls 19 mm x 12 m	N/A -
140262	Set of 12 rolls 25 mm x 12 m	N/A -

## Time Tape



All 12m tapes are on a 26mm ID cardboard tube and all 55m tapes are on a 76mm ID tube; regardless of tape width.

### Time Tape length 12 m

Width (mm)	13	19	25	38	50
White	140259A	140250A	140251A	140252A	140253A
Blue	140259B	140250B	140251B	140252B	140253B
Copper	140259C	140250C	140251C	140252C	140253C
Pink	140259D	140250D	140251D	140252D	140253D
Lime	140259E	140250E	140251E	140252E	140253E
Fuschia	140259F	140250F	140251F	140252F	140253F
Grey	140259G	140250G	140251G	140252G	140253G
Chartreuse	140259H	140250H	140251H	140252H	140253H
Yellow	140259J	140250J	140251J	140252J	140253J
Lavender	140259L	140250L	140251L	140252L	140253L
Violet	140259M	140250M	140251M	140252M	140253M
Black	140259N	140250N	140251N	140252N	140253N
Orange	140259P	140250P	140251P	140252P	140253P
Ochre	140259Q	140250Q	140251Q	140252Q	140253Q
Red	140259R	140250R	140251R	140252R	140253R
Salmon	140259S	140250S	140251S	140252S	140253S
Turquoise	140259T	140250T	140251T	140252T	140253T
Green	140259V	140250V	140251V	140252V	140253V
Price	N/A -	N/A -	N/A -	N/A -	N/A -

### Time Tape length 55 m

Width (mm)	13	19	25	38	50
White	140254A	140255A	140256A	140257A	140258A
Blue	140254B	140255B	140256B	140257B	140258B
Copper	140254C	140255C	140256C	140257C	140258C
Pink	140254D	140255D	140256D	140257D	140258D
Lime	140254E	140255E	140256E	140257E	140258E
Fuschia	140254F	140255F	140256F	140257F	140258F
Grey	140254G	140255G	140256G	140257G	140258G
Chartreuse	140254H	140255H	140256H	140257H	140258H
Yellow	140254J	140255J	140256J	140257J	140258J
Lavender	140254L	140255L	140256L	140257L	140258L
Violet	140254M	140255M	140256M	140257M	140258M
Black	140254N	140255N	140256N	140257N	140258N
Orange	140254P	140255P	140256P	140257P	140258P
Ochre	140254Q	140255Q	140256Q	140257Q	140258Q
Red	140254R	140255R	140256R	140257R	140258R
Salmon	140254S	140255S	140256S	140257S	140258S
Turquoise	140254T	140255T	140256T	140257T	140258T
Green	140254V	140255V	140256V	140257V	140258V
Price	N/A -	N/A -	N/A -	N/A -	N/A -

## Smooth masking tape

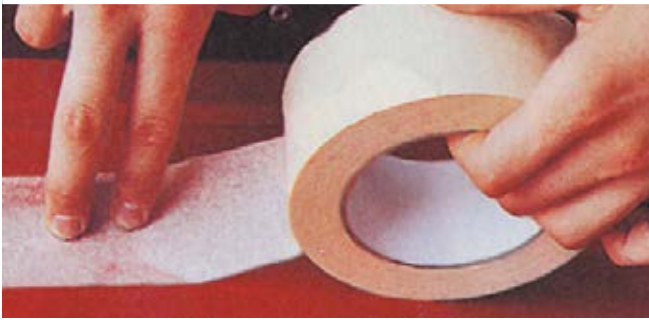

- Smooth paper tape for sealing
- Ideal for closing and isolating rooms before disinfection

Cat. No.	Description	Price the roll
150286A	Roll 18 mm x 50 m	N/A -
150264C	Roll 24 mm x 50 m	N/A -
150265C	Roll 36 mm x 50 m	N/A -
150266C	Roll 48 mm x 50 m	N/A -

## Aluminium adhesive tapes



- Can be used as a vapour barrier to seal joints and cracks
- Felt marking possible

Cat. No.	Temperature range (°C)	Thickness (mm)	Roll (m)	Price
764005	-40 to +140	0.04	100	N/A -
764006	-40 to +89	0.1	50	N/A -

## Multiple tape dispenser

- For 12 to 25 mm wide rolls
- Spindle diameter: 27 and 78 mm
- For 4 rolls of 25 mm width, and 5 or more rolls of 12 to 19 mm
- Dimensions: 302 x 143 x 106 mm

Cat. No.	Description	Price
086000	Eco tape dispenser to be fixed*	N/A -
947732	Tape dispenser, heavy duty metal base	N/A -

\* screws not supplied

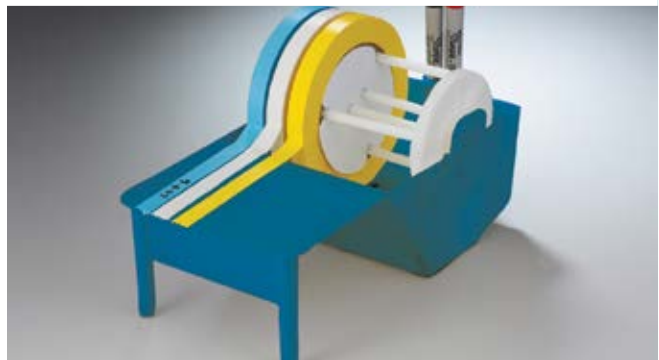

## Dispensers for adhesive tapes

2 types of dispensers:

- the manual dispenser for 2 rolls of 12 metres, width 13 mm or 25 mm;
- the transparent acrylic multi-dispenser for all roll widths (maximum capacity 240 mm width)

Cat. No.	Description	Price
140451	Manual dispenser for 2 rolls 12 m of 13 mm or a 12 m roll of 25 mm width	N/A -
140264	Acrylic dispenser for 12 m tapes	N/A -
140265	Acrylic dispenser for 55 m tapes	N/A -





## Close-it food labels



- ▶ For sealing holes after sampling in bags
- ▶ Aluminium-paper sandwich structure
- ▶ Compliant with the FDA standard
- ▶ Specially adapted to the food and pharmaceutical sector

Cat. No.	Colour	Printing	L x H (mm)	Units/roll	Price/roll
670830	Red	Yes	95 x 95	500	N/A -
670831	White	No	95 x 95	500	N/A -
670832	Red	Yes	150 x 150	250	N/A -
670833	White	No	150 x 150	250	N/A -

### Dispensers

Cat. No.	Description	Price
670828	Label dispenser for 95 x 95 labels	N/A -
670829	Label dispenser for 150 x 150 labels	N/A -

## Close-it control seal labels



- ▶ For sealing holes after sampling in bags
- ▶ Double membrane
- ▶ Aluminium-paper sandwich structure

Cat. No.	Colour	Model	L x H (mm)	Parts / roll	Price/roll
670816	Red	With printing	95 x 95	500	N/A -
670817	Green	With printing	95 x 95	500	N/A -
670818	Yellow	With printing	95 x 95	500	N/A -
670819	Blue	With printing	95 x 95	500	N/A -
670820	Black	With printing	95 x 95	500	N/A -
670821	White	Without printing	95 x 95	500	N/A -
670822	Red	With printing	150 x 150	250	N/A -
670823	Green	With printing	150 x 150	250	N/A -
670824	Yellow	With printing	150 x 150	250	N/A -
670825	Blue	With printing	150 x 150	250	N/A -
670826	Black	With printing	150 x 150	250	N/A -

### Dispensers

Cat. No.	Description	Price
670828	Label dispenser for 95 x 95 labels	N/A -
670829	Label dispenser for 150 x 150 labels	N/A -

## Tough-Spots Round labels for tube caps



Heavy duty round adhesive labels for identification and marking of tubes and microtubes on their caps. Particularly suitable for the caps of 0.5 to 2 ml microtubes and 15 ml and 50 ml conical tubes.

- In PVC
- Autoclavable
- Freezeable
- Can be immersed in a water bath at 100 °C
- Chemically resistant
- Tear-proof
- Accept marker marking
- Operating temperature: - 80 °C to + 121 °C
- On printing sheets or on rolls

	Labels on sheet					On a roll								
	9.5	11	13	19	25	4.8	9.5	9.5	11	13	13	19	25	
Disposition /sheets	12 x 16	13 x 18	12 x 16	9 x 12	7 x 9	-	-	-	-	-	-	-	-	
No. of labels/sheet	192	234	192	108	63	-	-	-	-	-	-	-	-	
Pr microtubes and tubes	0.5 to 1.5 ml	1.5 to 2 ml	1.5 to 2 ml	15 to 50 ml	50 ml	0.2 ml	0.5 to 1.5 ml	0.5 to 1.5 ml	1.5 to 2 ml	1.5 to 2 ml	1.5 to 2 ml	General	General	
No. labels /pack or /roll	3840	4680	3840	2160	1260	1500	1000	5000	1000	1000	5000	500	500	
White	053134	053163	053140	053146	053147	053165	053058	053362	053164	053063	053364	053389	053390	
Red	053135	-	053141	-	-	-	053059	-	-	053064	-	-	-	
Yellow	053136	-	053142	-	-	-	053060	-	-	053065	-	-	-	
Blue	053137	-	053143	-	-	-	053062	-	-	053067	-	-	-	
Green	053138	-	053144	-	-	-	053061	-	-	053066	-	-	-	
Orange	053139	-	053145	-	-	-	053380	-	-	-	-	-	-	
Assorted	-	-	-	-	-	-	-	053363	-	-	053365	-	-	
Brown	-	-	-	-	-	-	053376	-	-	053383	-	-	-	
Gold	-	-	-	-	-	-	053377	-	-	053384	-	-	-	
Lavender	-	-	-	-	-	-	053378	-	-	053385	-	-	-	
Brown	-	-	-	-	-	-	053379	-	-	053386	-	-	-	
Pink	-	-	-	-	-	-	053381	-	-	053387	-	-	-	
Silver	-	-	-	-	-	-	053382	-	-	053388	-	-	-	
Price/ pack (or /roll)	N/A -	N/A -	N/A -	N/A -	N/A -	N/A -	N/A -	N/A -	N/A -	N/A -	N/A -	N/A -	N/A -	

## Self-adhesive rectangular labels for microtubes and tubes Tough-Tags



- Labels for microtubes and tubes
- Pre-cut labels on sheet for computer printer
- Colour, white and transparent models
- They can withstand temperatures between - 40 °C and + 100 °C (water bath)

- Freezable and autoclavable
- Chemically resistant
- Tear-proof
- Marking with pen, felt-tip, pencil, marker
- Will not come off accidentally

Label size (mm)	32 x 13	24 x 13	20 x 7	38 x 19
For tubes type	Microtubes	Microtubes	Microtubes	Tubes
1.5 and 2 ml	0.5 ml	0.2 ml	haemolysis	
In roll of	1000	1000	1500	1000
White	<b>053044</b>	<b>053049</b>	<b>053056</b>	<b>053057</b>
Red	<b>053045</b>	<b>053050</b>	-	-
Yellow	<b>053046</b>	<b>053051</b>	-	-
Blue	<b>053047</b>	<b>053052</b>	-	-
Green	<b>053048</b>	<b>053053</b>	-	-
Orange	<b>053519</b>	<b>053518</b>	-	-
Transparent	<b>053054</b>	<b>053055</b>	-	-
Super CRYO -196 °C	<b>053071</b>	<b>053409</b>	-	<b>053072</b>
Price/ the roll	N/A -	N/A -	N/A -	N/A -

### On US letter size sheet, for computer printers (laser), standard labels, colour

Standard, pack of 25 sheets of	85 labels	119 labels	-	60 labels
Either	2125 labels	2975 labels	-	1500 labels
White	<b>053068</b>	<b>053069</b>	-	<b>053070</b>
Green	<b>053483</b>	<b>053494</b>	-	<b>053503</b>
Orange	<b>053488</b>	<b>053499</b>	-	<b>053504</b>
Red	<b>053487</b>	<b>053491</b>	-	<b>053505</b>
Yellow	<b>053476</b>	<b>053493</b>	-	<b>053506</b>
Blue	<b>053498</b>	<b>053500</b>	-	<b>053502</b>
Assorted	<b>053173</b>	<b>053501</b>	-	<b>053507</b>
Price/ the pack	N/A -	N/A -	-	N/A -

### On 21.6 x 27.9 cm sheets for computer printers, standard labels, white or transparent

L x W (mm)	38 x 19	38 x 13	27 x 13	25 x 25	23 x 8	67 x 5	41 x 16	216 x 279
Disposition per sheet	5 x 12	5 x 16	6 x 16	8 x 10	7 x 22	3 x 33	4 x 16	-
Number of labels per sheet	60	80	96	80	154	99	64	To cut
For	General	Tubes	Tubes	Slide of	PCR Tubes	Microplates	General	-
1.5 to 2 ml	0.5 ml	microscope	0.5 to 2 ml	0.2 ml				
Number of labels per sheet	1200	1600	1920	2000	3850	2475	1600	25
Transparent	<b>053509</b>	<b>053510</b>	<b>053511</b>	-	-	-	-	-
White	-	-	-	<b>053512</b>	<b>053514</b>	<b>053515</b>	<b>053516</b>	<b>053517</b>
Price/ pack	N/A -	N/A -	N/A -	N/A -	N/A -	N/A -	N/A -	N/A -

### Xylene resistant labels

- Polyester labels
- High resistance to solvents
- Operating temperature: - 40 °C to + 121 °C
- Resistant to water bath, autoclaving and freezing down to -40 °C

L x W (mm)	22 x 22
For	Microscope slides
Roll with 100	<b>053521</b>
Price/ roll	N/A -



See also: Brady labels in printable sheets page 1245



## ClearLine® Labels for cryogenics

- Operating temperature: -196 °C to +121 °C
- On US letter size sheet, for laser printer
- Marking with pen and marker
- Does not come off in a water bath

ClearLine



188459



188401

### Safety labels

Ø (mm)	9.5
Biohazard	188499
Radioactive	188500
Units/roll	1000
Price	N/A -

### Labels on sheet

Dimensions L x W or Ø (mm)	9.5	13	24 x 13	33 x 13	38 x 6	38 x 19	43 x 19	67 x 25	76 x 51	25 x 25
For	Microtubes 0.5 - 1.5 ml	Microtubes 1.5 - 2 ml	Microtubes 0.5 ml	Microtubes 1.5 - 2 ml	Microplates	General	Cryotubes	Boxes	Boxes	Microscope slides
White	188401	188408	188415	188422	188429	188436	188443	188450	188457	188458
Blue	188402	188409	188416	188423	188430	188437	188444	188451	-	-
Green	188403	188410	188417	188424	188431	188438	188445	188452	-	-
Yellow	188404	188411	188418	188425	188432	188439	188446	188453	-	-
Orange	188405	188412	188419	188426	188433	188440	188447	188454	-	-
Red	188406	188413	188420	188427	188434	188441	188448	188455	-	-
Units/package	3840	3840	2380	1700	3120	1200	1040	600	240	1600
Price	N/A -	N/A -	N/A -	N/A -	N/A -	N/A -	N/A -	N/A -	N/A -	N/A -
Assorted colours	188407	188414	188421	188428	188435	188442	188449	188456	-	-
Units/package	4800	4800	2975	2125	3900	1500	1300	750	-	-
Price	N/A -	N/A -	N/A -	N/A -	N/A -	N/A -	N/A -	N/A -	-	-

### Labels on roll

Dimensions L x W or Ø (mm)	9.5	13	19	25	21 x 7	24 x 13	33 x 13	38 x 19
For	Microtubes 0.5 - 1.5 ml	Microtubes 1.5 - 2 ml	Tubes 15 - 50 ml	Tubes 50 ml	Microtubes 0.5 ml	Microtubes 0.5 ml	Microtubes 1.5 - 2 ml	General use
White	188459	188471	188483	188484	188485	188486	188487	188493
Lavender	188460	188472	-	-	-	-	-	-
Blue	188461	188473	-	-	-	-	188488	188494
Green	188462	188474	-	-	-	-	188489	188495
Yellow	188463	188475	-	-	-	-	188490	188496
Orange	188464	188476	-	-	-	-	188491	188497
Pink	188465	188477	-	-	-	-	-	-
Red	188466	188478	-	-	-	-	188492	188498
Brown	188467	188479	-	-	-	-	-	-
Gold	188468	188480	-	-	-	-	-	-
Silver	188469	188481	-	-	-	-	-	-
Units/roll	1000	1000	1000	500	1500	1000	1000	1000
Price	N/A -	N/A -	N/A -	N/A -	N/A -	N/A -	N/A -	N/A -
Assorted colours*	188470	188482	-	-	-	-	-	-
Units/roll	5000	5000	-	-	-	-	-	-
Price	N/A -	N/A -	-	-	-	-	-	-

\* Colours: green, red, blue, yellow and purple.

## Acrylic dispenser and labels

- In acrylic
- Light blue colour
- To be placed on the bench or mounted on the wall (screws not included)

- With 4 non-slip feet
- For 6 boxes of 1000 labels

Cat. No.	Dimensions W x L x H (mm)	Price
141320	300 x 130 x 120	N/A -

### Round and rectangular labels

- Inert polyester
- For use until -196 °C
- Round labels: Ø = 9.5 mm
- Rectangular labels: L x W = 33 x 13 mm

Blue	Red	Green	Yellow	Violet	Units/ box	Price / box	Assorted*	Units/ box	Price / box
141322	141323	141324	141325	141326	1000	N/A -	141321	5000	N/A -
<b>Rectangular labels</b>									
141327	141328	141329	141330	141331	1000	N/A -	-	-	-

\* Uses two slots in the dispenser.



## Labels for cryotubes



### DT Cryo-spots labels

- ▶ Made of polypropylene
- ▶ Withstand temperatures from -196 °C to +70 °C
- ▶ For thermal printers
- ▶ 4000 labels/roll

Colours	Ø 9.5 mm For tube 0.5 ml	Ø 13 mm For tube 1.5 ml	Price the roll of 4000
Blue	053582	053588	N/A -
Green	053583	053589	N/A -
Orange	053584	053590	N/A -
Red	053585	053591	N/A -
Yellow	053586	053592	N/A -
White	053587	053593	N/A -

### Solvent/xylene resistant labels

- ▶ Resistant to solvents including xylene and acetone (short exposure)
- ▶ Withstands from -80 °C to +93 °C
- ▶ For thermal printers
- ▶ Easy to remove without residue

Cat. No.	Dimensions (mm)	Labels/ roll	Price the roll
053595	26 x 13	1000	N/A -
053596	38 x 13	750	N/A -
053597	38 x 19	750	N/A -
053598	22 x 22	1000	N/A -

### DT Cryo-tags and spot combo



- ▶ Withstand temperatures from -196 °C to +93 °C
- ▶ Format suitable for Nanodrop Lite printer
- ▶ Dim. tags L x W: 38 x 13 mm
- ▶ Spot diameter: 9.5 mm
- ▶ For tube 1.5 ml
- ▶ 500 labels/roll

Cat. No.	Description	Price the roll of 500
053594	Cryo-tags and spot combo labels	N/A -

## Special labels for cryogenic work



Adhesive labels specially designed for media used in cryogenic work: tubes, microtubes, cryotubes, conservation boxes, etc.

- ▶ Autoclavable
- ▶ Does not come off in a water bath
- ▶ Do not tear
- ▶ Highly resistant to chemical aggressors
- ▶ Operating temperature: up to -196 °C
- ▶ Packaged on 21.6 x 29.7 cm sheets for laser printers or on rolls of 1000

### Labels on roll

L x W (mm)	24 x 13	32 x 13	38 x 19
For tubes	Microtubes	Microtubes	General
type	0.5 ml	1.5 ml to 2 ml	
Cat. No.	053409	053071	053072
Price /roll of 1000	N/A -	N/A -	N/A -

### Labels on sheet

L x W (mm)	43 x 19	38 x 19	67 x 25	28 x 44	25 x 25	33 x 13	24 x 13	64 x 13	76 x 51	38 x 6
Disposition per sheet	4 x 13	5 x 12	3 x 10	7 x 6	8 x 10	5 x 17	7 x 17	3 x 20	4 x 3	4 x 39
Number of labels per sheet	52	60	30	42	80	85	119	60	12	156
Use	Cryotubes	General	Rack cryobox	General	Slide microscopy	Microtubes 1.5 ml	Microtubes 0.5 ml	Microtubes 0.5 to 2 ml	Flasks	Microplate
Number of labels per pack	1040	1200	600	840	1600	1700	2380	1200	240	3120
White	053104	053075	053115	053116	053117	053073	053121	053127	053128	053080
Transparent	-	-	-	-	-	053444	053445	-	-	-
Red	053105	053110	053529	-	-	053118	053122	-	-	053129
Yellow	053106	053111	053530	-	-	053089	053123	-	-	053130
Blue	053107	053112	053527	-	-	053090	053124	-	-	053131
Green	053108	053113	053528	-	-	053119	053125	-	-	053132
Orange	053109	053114	053475	-	-	053120	053126	-	-	053133
Assorted colours	053525	053524	053490	-	-	053520	053523	-	-	053526
Price/ pack	N/A -	N/A -	N/A -	N/A -	N/A -	N/A -	N/A -	N/A -	N/A -	N/A -

## Round and rectangular double label roll

For labelling tubes and caps simultaneously.

- > The roll includes:
  - 500 round labels  $\varnothing$  11 mm
  - 500 labels 33 x 13 mm

> Ideal for microtubes

Cat. No.	Colours	Price the roll of 500
053398	Blue	N/A -
053399	Green	N/A -
053403	Red	N/A -
053404	White	N/A -



## Write-protect labels

Transparent labels to cover and protect the marking on labels or microtubes.

- > Delivered in a pre-perforated roll on an dispenser
- > Adheres to all materials: plastic, glass, metal and label paper
- > Withstand temperatures from -190 °C to +150 °C

Cat. No.	Description	Price the roll of 1000
053093	Write-protect labels 32 x 13 mm	N/A -
053094	Write-protect labels 41 x 16 mm	N/A -



## Bake-Tags

For labelling products or buffers for molecular biology, requiring a heating step to deactivate RNases and DNases. Label format: 38 x 19 mm.

- > Labels can withstand temperatures up to 180 °C in dry heat
- > Withstand autoclaving, freezing in liquid nitrogen and boiling water in water baths
- > Resistant to most organic solvents, alcohols, acids and alkalis

Cat. No.	Description	Roll of	Price the roll
053095	Bake-Tags	250 tags	N/A -



## Wetgrip adhesive labels

Strong adhesive labels for wet, frosted or frozen tubes.

- > Temperature resistant to -80 °C
- > Attaches to wet and frozen surfaces
- > Adheres to plastics, glass, metals
- > Resistant to solvents and chemicals
- > Compatible with centrifuge rotors
- > White
- > In sheet form for laser printing

Size (mm)	Label layout	Cat. No.	Labels/box	Price / box
33 x 13	5/17	053447	1700	N/A -
24 x 13	7/17	053448	2380	N/A -
38 x 19	5/12	053449	1500	N/A -
22 x 22	8/12	053450	2400	N/A -



## Marking labels for microplates

- > Adhesive labels which are highly resistant to solvents and temperature variations (-80 °C to +120 °C), Irremovable and tear-proof
- > Designed to fit over the side of a microplate (or a Petri dish).
- > L x W: 38 x 6.4 mm, roll or sheet for laser printer.

Cat. No.	Description	Units/box	Price / box
053079	Labels in roll	1000	N/A -
053080	Labels on printing sheets	3120	N/A -





## Extra long labels for microtubes



Long labels to extend the information on the microtubes. They are fixed in a "flag" around the tube.

- > Irremovable and tear-proof
- > Label format: 63 x 12 mm
- > Resistant to most organic solvents and corrosives from -40 °C to +121 °C
- > Presented pre-cut on 21.6 x 27.9 cm sheets for computer printer (60 labels per sheet)

Cat. No.	Description	Price 1500 units
053078	Extra-long labels (25 x 60 labels)	N/A -

## Microscopy labels



Colour-coordinated adhesive labels with good solvent and temperature resistance (-70 °C to +100 °C) for microscope slides. L x W: 22 x 22 mm. Presentation on sheets of 96 labels for computer printers.

Orange	Blue	Green	Red	White	Yellow	Assorted	Price box of 2400
053156	053154	053155	053157	053006	053158	053159	N/A -

## Labels with red border



- > White self-adhesive labels with red border
- > For Glassware marking
- > Can be removed without leaving a residue

Cat. No.	Dimensions (mm)	Number of labels per roll	Price/box
764012	41 x 25	307	N/A -
764013	63 x 38	200	N/A -
764014	75 x 50	167	N/A -

## Label Remover



- > Removes adhesives and glue residues
- > Usable on all surface (test required before use on polystyren and polycarbonate)
- > Without chlorinated solvents
- > In aerosol
- > Do not use on the skin

Cat. No.	Volume (ml)	Price
280015	520	N/A -

## Coloured labels



Adhesive paper labels. On a roll.

Dimensions (mm)	Blue	Green	Pink	White	Yellow	Labels/roll	Price/roll
25 x 19	140000B	140001B	140002B	140003B	999757	5000	N/A -

## Grid pattern stickers for Petri dish

- Repositionable stickers for Petri dish 90 mm
- 76 mm diameter format
- With a numbered grid from 32 to 100 squares or as "pie chart" with 6 to 16 portions

Cat. No.	Type	Units/box	Price/box
053432	32 squares	36	N/A -
053433	50 squares	36	N/A -
053434	70 squares	36	N/A -
053435	100 squares	36	N/A -
053436	6 sectors	36	N/A -
053437	8 sectors	36	N/A -
053438	12 sectors	36	N/A -
053439	16 sectors	36	N/A -

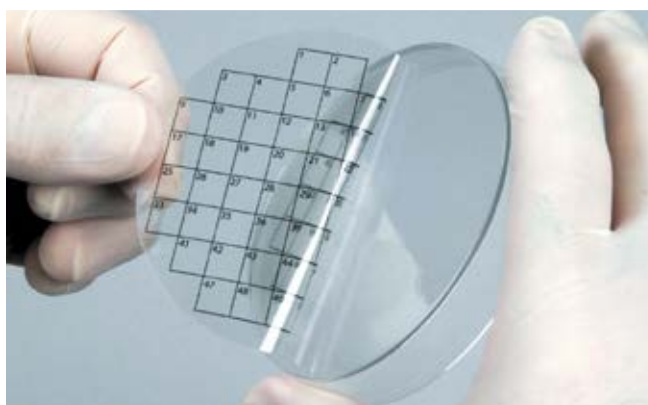

## Adhesive tapes

Cat. No.	Background colour/ text colour	Marking	Dimensions L x W (m x mm)	Price
150276	Green Black	"Contaminated"	12.7 x 13	N/A -
950166	Orange Black	"Corrosive"	12.7 x 13	N/A -
150275	Black Yellow	"Poison"	12.7 x 13	N/A -
950167	Red Yellow	"Flammable"	12.7 x 13	N/A -
150273	Yellow Red	"Radioactive"	12.7 x 13	N/A -



Customised adhesive strips: consult us



## Sealing tape

- Red sticker, black text « SCELLE JUDICIAIRE-NE PAS OUVRIR »
- Text length 21 cm
- Recommended for large volumes

Cat. No.	Description	Price/roll
784001	Red adhesive seal-roll from 100 m x 3 cm	N/A -



## Printed labels for microtubes

- For microtubes or small diameter tubes
- Adhesives
- Can be used from - 20 °C to + 80 °C
- In a dispenser of 500 labels

Cat. No.	Description	Price the roll of 500
442125	"Biohazard" Label	N/A -
442126	"Radioactive" Label	N/A -
442127	"Corrosive" Label	N/A -
442128	"Freeze" Label	N/A -
442129	"Toxic" Label	N/A -



## Round labels printed with safety symbols

Tough-Spots PVC labels.

- Diameter 9.5 mm
- For microtubes from 0.5 ml to 1.5 ml
- With "Radioactive" or "Biohazard" marking

Cat. No.	Description	Price the roll of 1000
053391	Tough-Spot marking "Biohazard"	N/A -
053395	Tough-Spot marking "Radioactif"	N/A -



## Biohazard label

Cat. No.	Colours	Dimensions L x W (mm)	Units/ box	Price/ box
140279	Fluorescent red	12.7 x 50.8	250	N/A -
950138	Fluorescent red	25.4 x 25.4	1000	N/A -
950139	Fluorescent red	76.2 x 50.8	250	N/A -
950164	Fluorescent red	127 x 127	250	N/A -



## Ribbons with radioactivity symbol



- ▶ Tape with radioactivity symbol
- ▶ Red print on yellow background

Cat. No.	Description	Width (mm)	Length (m)	Price the roll
140272	Radioactivity adhesive tape	13	55	N/A -
140273	Radioactivity adhesive tape	25	55	N/A -

## Adhesive tapes with radioactivity symbol and hazard warning

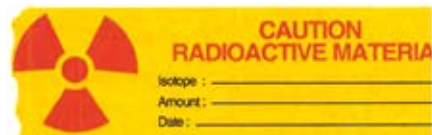

Cat. No.	Width (mm)	Length (m)	Phrase	Printing	Price
140274	25	55	«Attention matériel radioactif» + marking area: isotope / date / Cat. No.	Yellow background Red text	N/A -
950169	19	12.7	«Caution radioactive material» + marking area: isotope / date / Cat. No.	Yellow background Red text	N/A -
041080	25	66	«Danger radioactive material»	Orange background Black text	N/A -
950168	25	55	«Caution radioactive material»	Yellow background Red text	N/A -
950170	13	12.7	"Radioactive"	Yellow background Red text	N/A -

041080

950168

950170

## Safety labels



- ▶ Laminated polyester labels
- ▶ Roll of 250 labels
- ▶ Symbol Biohazard or Radioactivity

«Biohazard» Label			«Radioactivité» Label		
Cat. No.	Dimensions (mm)	Price the roll	Cat. No.	Dimensions (mm)	Price the roll
834428	25 x 22	N/A -	834435	25 x 22	N/A -
810925B	50 x 43	N/A -	834434	50 x 43	N/A -
834429	87 x 100	N/A -	834433	87 x 100	N/A -

## Radioactivity symbol labels



Round adhesive labels with radioactivity symbol for marking microtubes, tubes, glassware.

- ▶ Ø: 6.3 mm
- ▶ Roll of 1000 labels

Cat. No.	Description	Price the roll
045901	Radioactivity symbol labels	N/A -



GHS labels for hazardous products (NF compliant)

GHS pictograms are available on continuous rolls and in individual cuts.

- **Material: laminated polyester B-7541**
- **Rolls of 250 pictograms size 50 x 50 mm and 100 x 100 mm in both layouts**
- **Resistant to chemicals, temperature (-40 °C to +120 °C), rain, UV, scratches and abrasion**
- **Indoor or outdoor use**



**Composition of Cat. No. 814013**  
**Assortment of mini pictograms:**

- 11 x Explosive materials
- 16 x Flammable solids
- 11 x Oxidising materials
- 11 x Gases under pressure
- 11 x Danger of cutaneous sensitivity - inhalation
- 11 x Danger to the aquatic environment
- 11 x CMR Carcinogenic, mutagenic and reprotoxic risks
- 11 x Corrosive materials
- 11 x Toxic materials



All these symbols comply with the new GHS regulation, which was adopted by the Council of Europe on 28/11/08, and published in the Official Journal on 31/12/08. It comes into force from 20/01/09, but the mandatory dates for implementation are:  
 - 1 December 2010 for purely chemical substances  
 - 1 June 2015 for substances composed of chemicals.  
 GHS will replace the HSID labelling system.

Type	On sheets				On rolls			
	Dim. (mm) 10 x 10	Dim. (mm) 40 x 40	Dim. (mm) 70 x 70	Dim. (mm) 100 x 100	Dimensions (mm) 50 x 50		Dimensions (mm) 100 x 100	
	Cat. No.	Cat. No.	Cat. No.	Cat. No.	Roll	Pre-cut	Roll	Pre-cut
Explosive materials	814014	811680	811682	811678	811681	814032	814023	811679
Flammable solids	814015	811685	811687	811683	811686	814033	814024	811684
Oxidising materials	814016	811690	811692	811688	811691	814034	814025	811689
Gases under pressure	814017	811695	811697	811693	811696	814035	814026	811694
Danger of cutaneous sensitivity - inhalation	814018	811700	811702	811698	811701	814036	814027	811699
CMR Carcinogenic, mutagenic and reprotoxic risks	814020	811710	811712	811708	811711	814038	814029	811709
Corrosive materials	814021	811715	811717	811713	811716	814039	814030	811714
Toxic materials	814022	811720	811722	811718	811721	814040	814031	811719
Danger to the aquatic environment	814019	811705	811707	811703	811706	814037	814028	811704
<b>Packaging unit</b>	1 plate of 96	1 plate of 20	1 plate of 6	1 plate of 4	250	250	250	250
<b>Price</b>	N/A -	N/A -	N/A -	N/A -	N/A -	N/A -	N/A -	N/A -

**Mini pictograms on sheets** - pictograms in 10 x 10 mm.

Cat. No.	Type	Number of labels	Price
814013*	Set of mini pictograms	104	N/A -

\*See composition above.

Brady Pictograms

Adhesive polyester safety labels.

**First aid labels - ISO signage**

Type	Dimensions 100 x 100 mm	Dimensions 148 x 148 mm	Dimensions 200 x 200 mm
	Cat. No.	Cat. No.	Cat. No.
First aid	814545	834207	814547
Safety shower	814450	814451	814452
<b>Sales unit</b>	1	1	1
<b>Price</b>	N/A -	N/A -	N/A -



First Aid



Safety shower

**Obligation labels - NF standard**

Type	Ø 100 mm	Ø 200 mm
	Cat. No.	Cat. No.
Protective glasses	818420	912766
Opaque protective glasses	167382B	818868
Cotton blouses	806870	806873
Wearing overshoes	-	167388
<b>Sales unit</b>	1	1
<b>Price</b>	N/A -	N/A -



Special glasses required



Cotton lab coats required



Shoe covers wearing required



Other NF-compliant pictograms: see next page

## BRADY Pictograms (according to NF EN ISO 7010)

### Danger labels

- Permanent pressure sensitive adhesive, laminated polyester
- Presentation: on sheet
- Resistant to many chemicals and solvents
- Adheres to low surface energy substrates such as polypropylene and ABS, as well as to most powder coatings



General sign      Laser radiation      Magnetic field      Electricity



Hot area      Explosive atmosphere

Type	Side L. 50 mm	Side L. 100 mm	Side L. 200 mm	Side L. 315 mm
	Cat. No.	Cat. No.	Cat. No.	Cat. No.
General signal	834269	834270	834271	834272
Explosive materials	834273	834274	814419	834275
Radioactive materials or ionising radiation	834276	834277	834194	834278
Laser radiation	834279	834193	814481	834280
Non-ionising radiation	834281	834282	834283	834284
Magnetic field	834285	834286	834287	834288
Biohazard	940152	834195	827652	834289
Low temperatures, freezing conditions	814493	834196	814557	834290
Electricity	834291	834292	834293	834294
Toxic materials	834295	834197	834296	834297
Hot surface	834189	834298	834299	834300
Flammable materials	912785	912786	912787	912788
Corrosive substances	834301	834198	834302	834303
Optical radiation	834304	834305	834306	834307
Oxidising substances	834308	834199	834309	834310
Harmful or irritating materials	167435	167436	167437	834268
Explosive atmosphere	810881	810882	810885	810888
<b>Packaging unit</b>	7	3	1	1
<b>Price</b>	N/A -	N/A -	N/A -	N/A -

### Prohibition labels



Panels available in other dimensions and materials (PVC and aluminium): consult us.



No entry for unauthorised persons

Type	100 mm Ø	200 mm Ø
	Cat. No.	Cat. No.
No entry for unauthorised persons	810862	810865
<b>Packaging unit</b>	1	1
<b>Price</b>	N/A -	N/A -

## Overview of Brady labelling systems



BMP 21 Lab Label Printer



BMP 71



i3300



BMP 51



BBP 12



i5100

Models	BMP 21 Lab	BMP 51	BMP 71	BBP 12	i3300	i5100, i7100
<b>Connectable to PC/ Standalone</b>	Standalone	Standalone & Connectable to PC	Standalone & Connectable to PC	Connectable to PC	Connectable to PC	Connectable to PC
<b>Portable</b>	Portable	Portable	Portable	Bench printer	Bench printer	Bench printer
<b>Software for labelling</b>	-	Brady Workstation	Brady Workstation	Brady Workstation	Brady Workstation	Brady Workstation
<b>Continuous consumable / pre-cut</b>	Continuous	Continuous & pre-cut	Continuous & pre-cut	Continuous & pre-cut	Continuous & pre-cut	Continuous & pre-cut
<b>Cartridge / Tape Roll</b>	Cartridge	Cartridge	Labels on roll with separate tape	Labels on roll with separate tape	Labels on a roll with separate tape	Labels on roll with separate tape
<b>Max. label height</b>	19 mm	38.10 mm	50, 80 mm	100 mm	100 mm	100 mm
<b>Resolution</b>	180 dpi	300 dpi	300 dpi	300 dpi	300 dpi	300 dpi to 600 dpi
<b>Applications</b>	Labels for laboratories: tubes, tube trays, coverslips	Labels for laboratories: tubes, tube trays, coverslips, straws, tube caps	Labels for laboratories: tubes, tube trays, coverslips, straws, tube caps	Labels for laboratories: tubes, tube trays, coverslips, straws, tube caps	Labels for laboratories: tubes, tube trays, slides, straws, tube caps	Labels for laboratories: tubes, tube trays, coverslips, straws, tube caps

## Material guide

Material Brady	Ribbon Series	Temp. (°C)	Applications							Environment				Low-Profile	Specific properties
			Tubes	slide	Flasks	Trays	Pipette	Cassette	ID General	Freezer	Liquid nitrogen	Autoclavable (121 °C)	Boiling water bath (100 °C)		
<b>Freezerbondz™ Polyester</b>															
<b>B-490</b>	R-4300 R-7950	-196 to +120	✓		✓	✓			✓	✓	✓	✓	✓	✓	Label material that will adhere to frozen surfaces. The material should wrap around itself slightly
<b>B-492</b>	R-6400	-196 to +120	✓		✓	✓	✓		✓	✓	✓	✓	✓	✓	Label material that will adhere to frozen surfaces.
<b>Nylon fabric</b>															
<b>B-499</b>	R-4300 R-7950 R-6000	-196 to +90	✓		✓	✓			✓	✓	✓				Permanent adhesive, excellent writing capabilities
<b>Paper</b>															
<b>B-424</b>	R-4300 R-7950	-90 to +50		✓											Permanent adhesive; good contrast; excellent writing capabilities
<b>Polyester</b>															
<b>B-423</b>	R-6000 (colour)	-80 to +120				✓			✓	✓				✓	Permanent acrylic adhesive; ideal for flat surfaces
<b>B-430</b>	R-6000	-80 to +100							✓	✓				✓	Polyester with permanent acrylic adhesive. Resistant to many solvents and can be applied to many surfaces.
<b>B-432</b>	R-6000	-80 to +100							✓	✓				✓	Polyester with permanent acrylic adhesive. Resistant to many solvents and can be applied to many surfaces.
<b>B-433</b>	R-6000	-40 to +100							✓	✓				✓	
<b>B-461</b>	R-4300 R-7950	-196 to +130	✓		✓		✓			✓	✓	✓	✓	✓	Permanent adhesive; suitable for liquid nitrogen applications. Excellent writing skills. Requires overlapping label ends for a perfect fit.
<b>B-7425</b>	R-4300 R-7950	-196 to +130	✓		✓		✓			✓	✓	✓	✓	✓	Permanent adhesive; suitable for liquid nitrogen applications. Excellent writing skills. Requires overlapping label ends for a perfect fit.
<b>B-482</b>	R-6400	-80 to +130							✓		✓	✓	✓		In combination with the R6400 ribbon, this material offers the high print quality and resistance to paraffin and solvents required in the field of histology and ana-path. In combination with the BSP <sub>31</sub> Cassette Label Heat Seal System, this material offers very high tear resistance.
<b>B-488</b>	R-4300 R-6200 R-7950	-80 to +120	✓	✓	✓	✓			✓	✓		✓	✓		Permanent acrylic adhesive; ideal for flat surfaces; excellent writing capabilities; excellent solvent resistance and xylene resistance
<b>B-8423</b>	R-4300 R-7950	-80 to +120				✓			✓	✓				✓	THT with permanent acrylic adhesive. Semi-gloss finish; excellent for barcode labels
<b>Polypropylene</b>															
<b>B-425</b>	R-6400	-70 to +100	✓		✓	✓			✓	✓					Excellent solvent resistance (with R6400 ribbon)
<b>B-449</b>	R-6400 R-7950	-80 to +90	✓		✓				✓	✓					Repositionable on flat surfaces; excellent writing capabilities
<b>StainerBondz™ Polypropylene</b>															
<b>B-481</b>	R-6400	-80 to +130		✓					✓	✓	✓	✓			Designed for slide identification, and combined with the R-6400 tape, it offers a very high resistance to Xylene type solvents.
<b>Tamper-Resistant Vinyl</b>															
<b>B-351</b>	R-6000	-80 to +120							✓						Tamper-proof film with permanent acrylic adhesive; breaks easily, preventing removal
<b>B-7351</b>	R-6000	-40 to +100													Tamper-proof film with permanent acrylic adhesive; breaks easily, preventing removal
<b>Vinyl</b>															
<b>B-427</b>	R-4300 R-7950	-80 to +70	✓		✓		✓			✓	✓				Permanent acrylic adhesive; self-adhesive; excellent writing capabilities; suitable for liquid nitrogen applications and can be used to identify a frozen tube if the label material is wrapped around itself, as in self-adhesion
<b>B-595</b>	R-6000 (black) R-4400 or R-6900 (colour)	-40 to +82							✓						Very high performance vinyl. Available in white, red, yellow, green, blue, orange, black, grey, brown, gold, purple and transparent.
<b>Vinyl fabric</b>															
<b>B-498</b>	R-6200	-80 to +80	✓	✓	✓	✓			✓	✓	✓	✓	✓		Repositionable on flat surfaces; excellent writing capabilities

## Ribbon Guide

Printer Ribbon size	Printer Ip300	BBP11		BMP71		
		110 mm x 300 m	60 mm x 300 m	110 mm x 70 m	65 mm x 70 m	46 mm x 50.8 m
<b>Family</b>	<b>Material</b>					
R-4300 / R7950	Wax/Resin	iPR-4307 (065886)	iPR-4302 (066028)	R-7950 (804465)	R-7950 (804467)	M71-R4300 (114548)
<b>Cat. No.</b>		<b>167858</b>	-	<b>804465</b>	<b>814042</b>	<b>167927</b>
R-6000	Resin	iPR-6007 (065959)	iPR-6000 (066202)	R-6000HF (396516)	-	M71-R6000 (114547)
<b>Cat. No.</b>		<b>167859</b>	<b>167907</b>	<b>814492</b>	-	<b>167926</b>
R-6400	ResinExternal Resistance to solvents	iPR-6407 (110381)	iPR-6400 (066236)	R-6400 (804778)	R-6400 (804777)	M71-R6400 (114556)
<b>Cat. No.</b>		<b>167905</b>	-	<b>804778</b>	<b>804777</b>	<b>167638</b>
R-6200	Resin	-	-	-	-	M71-R6200 (114549)
<b>Cat. No.</b>		-	-	-	-	<b>167925</b>

### Composition label Cat. No.

THT	152	489	3
Print Type	Label size	Material	Quantity label/rolls

### Composition labels for BBP11 Cat.No.

THT	152	489	3	SC
Print Type	Label size	Mat.	Quantity label/rolls	Cat. No. ended by SC



## BMP21-LAB labeller



- **Robust**
- **3-line LCD display**
- **ABC keyboard, graphic library, shortcut keys and function menu for quick label creation**
- **Symbols commonly used in laboratory**
- **Long-life rechargeable lithium battery**
- **Automatic label configuration**
- **Supplied with neck lanyard, quick start guide and M21-750-7425 labels**
- **Warranty: 2 years**



See the material selection guide page 1247

### Labels for BMP21-LAB

Cat. No.	Description	Width (mm)	Length (m)	Cat. No. Brady	Price
<b>Polyester labels B-461</b>					
167033	Black on white	9.53	6.4	M21-375-461	N/A -
167034	Black on white	12.7	6.4	M21-500-461	N/A -
167035	Black on white	19.05	6.4	M21-750-461	N/A -
<b>Nylon fabric labels B-499</b>					
167036	Black on white	9.53	4.8	M21-375-499	N/A -
167037	Black on white	12.7	4.8	M21-500-499	N/A -
167038	Black on white	19.05	4.8	M21-750-499	N/A -
<b>Polyester labels B-488</b>					
167039	Black on white	9.53	6.4	M21-375-488	N/A -
167040	Black on white	12.7	6.4	M21-500-488	N/A -
167041	Black on white	19.05	6.4	M21-750-488	N/A -
<b>Polyester labels B-423</b>					
167042	Black on white	9.53	6.4	M21-375-423	N/A -
167043	Black on white	12.7	6.4	M21-500-423	N/A -
167044	Black on white	19.05	6.4	M21-750-423	N/A -
<b>Polyester labels B-430</b>					
167045	Black on transparent	9.53	6.4	M21-375-430	N/A -
167046	Black on transparent	12.7	6.4	M21-500-430	N/A -
167047	Black on transparent	19.05	6.4	M21-750-430	N/A -
<b>Polypropylene labels B-7425</b>					
814356	Black on white	9.53	6.4	M21-375-7425	N/A -
814357	Black on white	12.7	6.4	M21-500-7425	N/A -
814358	Black on white	19.05	6.4	M21-750-7425	N/A -

Cat. No.	Description	Price
814354	BMP21-LAB labeller	N/A -
814355	BMP21-LAB* labelling kit	N/A -

\* Includes BMP21-LAB labeller, lithium battery, power cable, neck cord, quick start guide, M21-750-7425 labels.

### Accessories

Cat. No.	Description	Price
110416	220V power adapter	N/A -
814253	Lithium battery	N/A -

### Labels for BMP21-LAB

Cat. No.	Description	Width (mm)	Length (m)	Cat. No. Brady	Price
<b>Vinyl labels B-595</b>					
167051	White on blue	9.53	6.4	M21-375-595-BL	N/A -
167056	White on blue	12.7	6.4	M21-500-595-BL	N/A -
167061	White on blue	19.05	6.4	M21-750-595-BL	N/A -
814256	White on brown	9.53	6.4	M21-375-595-BR	N/A -
814257	White on brown	12.7	6.4	M21-500-595-BR	N/A -
814258	White on brown	19.05	6.4	M21-750-595-BR	N/A -
814259	White on black	9.53	6.4	M21-375-595-BK	N/A -
814260	White on black	12.7	6.4	M21-500-595-BK	N/A -
814261	White on black	19.05	6.4	M21-750-595-BK	N/A -
167054	White on red	9.53	6.4	M21-375-595-RD	N/A -
167059	White on red	12.7	6.4	M21-500-595-RD	N/A -
167064	White on red	19.05	6.4	M21-750-595-RD	N/A -
167052	White on green	9.53	6.4	M21-375-595-GN	N/A -
167057	White on green	12.7	6.4	M21-500-595-GN	N/A -
167062	White on green	19.05	6.4	M21-750-595-GN	N/A -
814262	White on purple	9.53	6.4	M21-375-595-PL	N/A -
814263	White on purple	12.7	6.4	M21-500-595-PL	N/A -
814264	White on purple	19.05	6.4	M21-750-595-PL	N/A -
814265	Black on white	6.35	6.4	M21-250-595-WT	N/A -
167048	Black on white	9.53	6.4	M21-375-595-WT	N/A -
167049	Black on white	12.7	6.4	M21-500-595-WT	N/A -
167050	Black on white	19.05	6.4	M21-750-595-WT	N/A -
814266	Black on grey	9.53	6.4	M21-375-595-GY	N/A -
814267	Black on grey	12.7	6.4	M21-500-595-GY	N/A -
814268	Black on grey	19.05	6.4	M21-750-595-GY	N/A -
814269	Black on yellow	6.35	6.4	M21-250-595-YL	N/A -
167055	Black on yellow	9.53	6.4	M21-375-595-YL	N/A -
167060	Black on yellow	12.7	6.4	M21-500-595-YL	N/A -
167065	Black on yellow	19.05	6.4	M21-750-595-YL	N/A -
167053	Black on orange	9.53	6.4	M21-375-595-OR	N/A -
167063	Black on orange	19.05	6.4	M21-750-595-OR	N/A -

## BMP51 Printer

- **Compact printer for continuous or label printing**
- **With keyboard and display**
- **Max. label length: 38.10 mm**
- **Maximum of 250 labels/day**
- **A cartridge with integrated ribbon**
- **Stand-alone operation or via a PC**
- **Integrated cutter**
- **Warranty: 2 years**



### Accessories

Cat. No.	Description	Price
814187	Magnetic holder	N/A -
814083	Hard case	N/A -
167924	Battery charger 220v (EUROPE)	N/A -
814085	Additional Li-Ion battery	N/A -
814087	Additional Li-Ion battery + 220 v charger	N/A -
814088	Case for 8 AA batteries	N/A -
814091	Ethernet card	N/A -

### Printer kits

Cat. No.	Description	Price
814077	BMP51 Printer*	N/A -
834204	BMP51 Lab Printer Kit* with Brady Workstation	N/A -
834664	BMP51 printer pack + LABS suite	N/A -

\* Lab Kit: BMP51 + + Brady Workstation Basic + M-122-461 + M-131-499 + MC-1500-595-WT-BK



Other labels for BMP51 next page

## Labels for BMP51

Figure	Cat. No.	Description	Width (mm) A	Height B	Length (mm) C	Cat. No. Brady	Quantity	Price
<b>White polyester labels B-422</b>								
1	814094	Labels	12.7	12.7 mm	-	M-7-422	280	N/A -
2	814188	Continuous label	9.53	7.62 m	-	MC-375-422	-	N/A -
2	814189	Continuous label	12.07	7.62 m	-	MC-475-422	-	N/A -
2	814190	Continuous label	12.7	7.62 m	-	MC-500-422	-	N/A -
2	814191	Continuous label	25.4	7.62 m	-	MC-1000-422	-	N/A -
1	814095	Labels	25.4	12.7 mm	-	M-17-422	480	N/A -
1	814097	Labels	38.1	12.7 mm	-	M-29-422	180	N/A -
<b>Clear polyester labels</b>								
1	814099	Labels	25.4	12.7 mm	-	M-17-432-CL-BK	280	N/A -
<b>Self-protected polyester labels B-461 for liquid nitrogen in white polyester</b>								
2	814100	Continuous label (without transparent part)	9.53	7.62 m	-	MC-375-461	-	N/A -
3	814101	Labels with transparent self-laminating	41.91	12.7 mm	19.05	M-124-461	180	N/A -
3	814102	Labels with transparent self-laminating	44.45	12.7 mm	19.05	M-72-461	180	N/A -
3	814103	Labels with transparent self-laminating	55.88	12.7 mm	19.05	M-74-461	140	N/A -
2	814104	Continuous label (without transparent part)	12.7	7.62 m	-	MC-500-461	-	N/A -
3	814105	Labels with transparent self-laminating	45.72	15.24 mm	25.4	M-126-461	180	N/A -
3	814106	Labels with transparent self-laminating	66.68	15.24 mm	25.4	M-86-461	120	N/A -
3	814107	Labels with transparent self-laminating	44.45	25.4 mm	25.4	M-125-461	180	N/A -
3	814108	Labels with transparent self-laminating	66.68	9.53 mm	25.4	M-75-461	120	N/A -
2	814109	Continuous label (without transparent part)	25.4	7.62 m	-	MC-1000-461	-	N/A -
3	814115	Labels with transparent self-laminating	28.58	9.53 mm	19.05	M-123-461	360	N/A -
3	814110	Labels with transparent self-laminating	28.58	12.7 mm	19.05	M-122-461	360	N/A -
2	814111	Continuous strip (without transparent part)	31.75	7.62 m	-	MC-1250-461	-	N/A -
3	814114	Labels with transparent self-laminating	57.15	38.10 mm	31.75	M-129-461	140	N/A -
3	814113	Labels with transparent self-laminating	95.25	38.1 mm	31.75	M-119-461	80	N/A -
<b>White adhesive reinforced polyester labels</b>								
1	814116	Labels with reinforced adhesive	12.7	50.8 mm	-	M-61-483	80	N/A -
1	814117	Labels with reinforced adhesive	25.4	12.7 mm	-	M-17-483	480	N/A -
1	814118	Labels with reinforced adhesive	50.8	25.4 mm	-	M-20-483	140	N/A -
<b>White matt polyester labels B-488</b>								
1	814119	Matte labels	6.35	48.26 mm	-	M-81-488	160	N/A -
1	814120	Matte labels	22.86	22.86 mm	-	M-97-488	280	N/A -
<b>Polypropylene labels B-481</b>								
1	814270	Labels	22.86	19.05	-	M-194-481	320	N/A -
1	814271	Labels	25.4	19.53	-	M-195-481	320	N/A -
1	814272	Labels	22.86	22.86	-	M-97-481	280	N/A -
<b>White polyester labels freezerbondz</b>								
1	814121	White polyester labels for cryogenics B-490	41.91	12.7	-	M-124-490	180	N/A -
1	814122	White polyester labels for cryogenics B-490	45.72	15.24	-	M-126-490	180	N/A -
1	814123	White polyester labels for cryogenics B-490	44.45	25.4	-	M-125-490	180	N/A -
1	814124	White polyester labels for cryogenics B-490	31.75	9.53	-	M-112-490	360	N/A -
1	814125	White polyester labels for cryogenics B-490	55.88	38.1	-	M-113-490	140	N/A -
1	814126	White polyester labels for cryogenics B-490	95.25	38.1	-	M-114-490	80	N/A -
5	814127	White polyester labels for cryogenics B-492	9.53	9.53	-	M-82-492	240	N/A -
1	814128	White polyester labels for cryogenics B-492	20.96	9.53	-	M-130-492	220	N/A -
4	814131	White polyester labels for cryogenics B-492	25.4	9.53	-	M-118-492	240	N/A -
1	814129	White polyester labels for cryogenics B-492	25.4	12.7	-	M-131-492	180	N/A -
4	814132	White PE labels for cryogenics B-492 tube + cap	25.4	12.7 + ø 9.5	-	M-120-492	240	N/A -
4	814133	White PE labels for cryogenics B-492 tube + cap	25.4	12.7 + ø 11.2	-	M-117-492	240	N/A -
1	814130	White polyester labels for cryogenics B-492	22.86	25.4	-	M-156-492	180	N/A -
1	814134	White polyester labels for cryogenics B-492	25.4	48.26	-	M-78-492	100	N/A -
-	814338	Labels	41.28	15.24	9.53	M-95-492	200	N/A -
1	814339	Labels	31.75	9.53	-	M-112-492	360	N/A -
1	814340	Labels	41.91	12.7	-	M-124-492	180	N/A -
1	814341	Labels	44.45	25.4	-	M-125-492	180	N/A -
5	814342	Labels	12.7	-	-	M-83-492	240	N/A -
2	814343	Labels	7.62	12.7	-	MC-500-492	1	N/A -
1	814344	Labels	31.75	6.35	-	M155-492	180	N/A -
<b>White polyester labels B-422</b>								
1	814278	Labels	25.4	25.4	-	M-49-422	260	N/A -
1	814280	Labels	19.05	38.1	-	M-90-422	180	N/A -

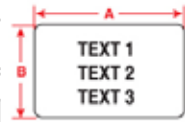

Fig.1

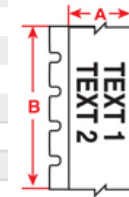

Fig.2

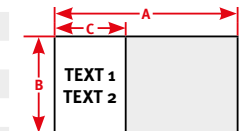

Fig.3

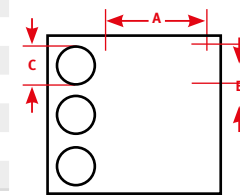

Fig.4

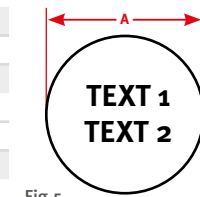

Fig.5

IDENTIFICATION, PROTECTION, WASTE MANAGEMENT

HEALTH AND SAFETY

Other colours available: consult us



Other labels for BMP51 next page

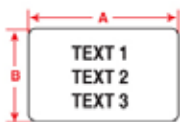

Fig.1

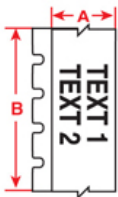

Fig.2

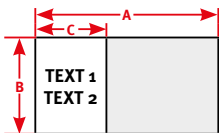

Fig.3

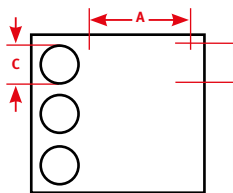

Fig.4

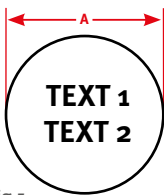

Fig.5

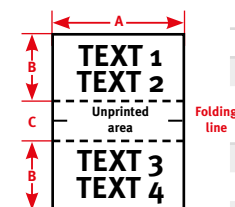

Fig.6

## Labels for BMP51

Figure	Cat. No.	Description	Colour	Width (mm) A	Height B	Length (mm) C	Cat. No. Brady	Quantity	Price
<b>Ultra-destructible vinyl labels B-351, in white vinyl</b>									
1	814093	Ultra-destructible labels	White	25.4	12.7 mm	-	M-17-351	360	N/A
<b>Continuous strip and white vinyl labels B-498</b>									
2	814135	Label	White	6.1	4.88 m	-	MC-240-498	-	N/A
2	814136	Label	White	8.08	4.88 m	-	MC-318-498	-	N/A
2	814137	Label	White	9.53	4.88 m	-	MC-375-498	-	N/A
1	814138	Labels	White	12.7	12.7 mm	-	M-7-498	240	N/A
1	814139	Labels	White	12.7	19.05 mm	-	M-11-498	220	N/A
1	814141	Labels	White	25.4	12.7 mm	-	M-131-498	180	N/A
1	814142	Labels	White	19.05	25.4 mm	-	M-18-498	180	N/A
1	814143	Labels	White	25.4	25.4 mm	-	M-19-498	160	N/A
1	814144	Labels	White	25.4	38.1 mm	-	M-31-498	120	N/A
1	814145	Labels	White	25.4	48.26 mm	-	M-78-498	100	N/A
1	814146	Labels	White	25.4	31.75 mm	-	M-103-498	160	N/A
<b>B-595 high performance vinyl labels, various colours (orange, white, yellow)</b>									
2	814163	Continuous label with black writing	White	12.7	6.1 m	-	MC-500-595-CL-BK	-	N/A
2	814164	Continuous label with black writing	White	25.4	6.1 m	-	MC-1000-595-CL-BK	-	N/A
2	814165	Continuous label with black writing	White	38.1	6.1 m	-	MC-1500-595-CL-BK	-	N/A
2	814166	Continuous label with black writing	Orange	12.7	7.62 m	-	MC-500-595-OR-BK	-	N/A
2	814167	Continuous label with black writing	Orange	25.4	7.62 m	-	MC-1000-595-OR-BK	-	N/A
2	814168	Continuous label with black writing	Orange	38.1	7.62 m	-	MC-1500-595-OR-BK	-	N/A
2	814169	Continuous label with black writing	White	12.7	7.62 m	-	MC-500-595-WT-BK	-	N/A
2	814170	Continuous label with black writing	White	25.4	7.62 m	-	MC-1000-595-WT-BK	-	N/A
2	814171	Continuous label with black writing	White	38.1	7.62 m	-	MC-1500-595-WT-BK	-	N/A
2	814172	Continuous label with black writing	Yellow	12.7	7.62 m	-	MC-500-595-YL-BK	-	N/A
2	814173	Continuous label with black writing	Yellow	25.4	7.62 m	-	MC-1000-595-YL-BK	-	N/A
2	814174	Continuous label with black writing	Yellow	38.1	7.62 m	-	MC-1500-595-YL-BK	-	N/A
2	814175	Continuous label with red writing	White	12.7	7.62 m	-	MC-500-595-WT-RD	-	N/A
2	814176	Continuous label with red writing	White	25.4	7.62 m	-	MC-1000-595-WT-RD	-	N/A
2	814177	Continuous label with red writing	White	38.1	7.62 m	-	MC-1500-595-WT-RD	-	N/A
2	814178	Continuous label with white writing	Blue	12.7	7.62 m	-	MC-500-595-BL-WT	-	N/A
2	814179	Continuous label with white writing	Blue	25.4	7.62 m	-	MC-1000-595-BL-WT	-	N/A
2	814180	Continuous label with white writing	Blue	38.1	7.62 m	-	MC-1500-595-BL-WT	-	N/A
2	814181	Continuous label with white writing	Green	12.7	7.62 m	-	MC-500-595-GN-WT	-	N/A
2	814182	Continuous label with white writing	Green	25.4	7.62 m	-	MC-1000-595-GN-WT	-	N/A
2	814183	Continuous label with white writing	Green	38.1	7.62 m	-	MC-1500-595-GN-WT	-	N/A
2	814184	Continuous label with white writing	Red	12.7	7.62 m	-	MC-500-595-RD-WT	-	N/A
2	814185	Continuous label with white writing	Red	25.4	7.62 m	-	MC-1000-595-RD-WT	-	N/A
2	814186	Continuous label with white writing	Red	38.1	7.62 m	-	MC-1500-595-RD-WT	-	N/A
<b>B-595 high performance vinyl labels, various colours (orange, white, yellow, green, blue, red)</b>									
6	814275	Continuous label with white writing	Black	25.4	7.62 m	-	MC1-1000-595-BK-WT	-	N/A
6	814276	Continuous label with white writing	Transp.	25.4	6.09 m	-	MC1-1000-595-CL-WT	-	N/A
<b>Nylon fabric labels B-499, various colours (orange, white, yellow)</b>									
5	814147	Labels (Fig. 1)	Orange	∅ 9.53	-	-	M-82-499-OR-BK	240	N/A
5	814359	Labels	Red	∅ 9.53	-	-	M-82-499-RD-BK	240	N/A
5	814148	Labels (Fig. 1)	White	∅ 9.53	-	-	M-82-499	240	N/A
5	814149	Labels (Fig. 1)	White	∅ 12.7	-	-	M-83-499	240	N/A
5	814150	Labels (Fig. 1)	Yellow	∅ 9.53	-	-	M-82-499-YL-BK	240	N/A
5	814151	Labels (Fig. 1)	Yellow	∅ 12.7	-	-	M-83-499-YL-BK	240	N/A
5	814273	Labels	Orange	∅ 12.7	-	-	M-83-499-OR-BK	240	N/A
5	814274	Labels	Red	∅ 12.7	-	-	M-83-499-RD-BK	240	N/A
5	814156	Cap labels + Tube (Fig. 2)	White	25.4	9.5 + ∅ 9.5	-	M-118-499	240	N/A
1	814152	Labels	White	20.96	9.53	-	M-130-499	220	N/A
1	814154	Labels	White	19.05	12.7	-	M-11-499	220	N/A
1	814153	Labels	White	25.4	12.7	-	M-131-499	180	N/A
4	814157	Cap labels + Tube (Fig. 2)	White	25.4	12.7	11.18	M-117-499	240	N/A
4	814158	Cap labels + Tube (Fig. 2)	White	25.4	12.72 + ∅ 9.53	-	M-120-499	240	N/A
6	814161	Cloth labels for cable flags (central area 6.35 mm) (Fig. 3)	White	38.1	12.7	6.35	M-152-499	160	N/A
6	814159	Labels for cable flags (central area 6.35 mm) (Fig. 3)	White	25.4	25.4	6.35	M-151-499	90	N/A
1	814162	Labels	White	31.75	38.1	-	M-132-499	160	N/A
1	814160	Labels	White	48.26	25.4	-	M-78-499	100	N/A

Other colours available: consult us



Other labels for BMP51 next page



## Labels for BMP51

Figure	Cat. No.	Description	Colour	Width (mm) A	Height (mm) B	Length (mm) C	Cat. No. Brady	Quantity	Price
<b>Self-adhesive vinyl labels B-427</b>									
7	814281	Labels	White	25.4	19.05	9.53	M-136-427	340	N/A -
7	814282	Labels	White	25.4	12.7	9.53	M-47-427	360	N/A -
7	814351	Labels	White	25.4	19.05	9.53	M-48-427	200	N/A -
7	814352	Labels	White	25.4	25.4	9.53	M-49-427	260	N/A -
7	814283	Labels	White	25.4	63.5	19.05	M-51-427	110	N/A -
7	814284	Labels	White	25.4	101.6	25.4	M-53-427	70	N/A -
7	814285	Labels	White	6.35	27.94	-	M-135-427-AW	240	N/A -
7	814286	Labels	White	25.4	31.8	12.7	M-143-427	200	N/A -
7	814287	Labels	White	12.7	38.1	12.7	M-89-427	180	N/A -
7	814288	Labels	White	19.05	38.1	12.7	M-90-427	180	N/A -
7	814252	Labels	White	25.4	38.1	12.7	M-91-427	180	N/A -
7	814289	Labels	Yellow	25.4	63.5	19.05	M-51-427-YL	110	N/A -
7	814290	Labels	Yellow	25.4	101.6	25.4	M-53-427-YL	70	N/A -
7	814291	Labels	Yellow	25.4	38.1	12.7	M-91-427-YL	180	N/A -

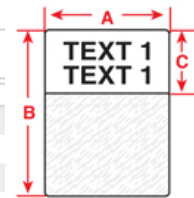

Fig.7

## BMP71 Printer

The BMP71 printer is delivered with:

- aC adapter (which also doubles as a battery charger) and USB cable;
- adapter for TLS label rolls;
- transport case with cleaning kit and instructions;
- an M71-R6000 ink ribbon;
- two rolls of labels (M71C-2000-595-WT (white vinyl continuous strip), and M71-19-423 (white polyester label 25 x 25 mm)).

- **Robust thermal transfer printer**
- **PC connectable with LabelMark software, stand-alone with Azerty keyboard**
- **Large colour and graphic display; on-screen indicators for:**
  - the number of labels installed
  - the size and colour of the label
  - the number of labels remaining on the roll
  - the battery level
  - the label and area status
  - the current text size and rotation
- **Warranty: 2 years**



Cat. No.	Description	Price
834666	Printer BMP71 + LABS suite	N/A -

See material selection guide on page 1247

## Ribbons

Cat. No.	Description	Price
167638	Printer ribbon M71-R6400 black RC	N/A -
167925	Printer ribbon M71-R6200 black RC	N/A -
167926	Printer ribbon M71-R6000 black RC	N/A -
167927	Printer ribbon M71-R4300 black RC	N/A -



Labels for BMP71 on the following pages

## Labels for Brady BMP71 printer

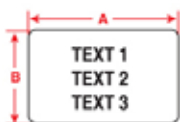

Fig.1

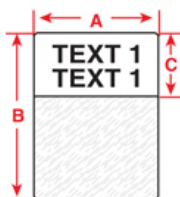

Fig.7

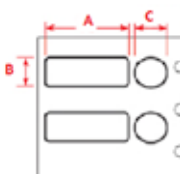

Fig.8

### Labels for BMP71

Figure	Cat. No.	Description	Colour	Width (mm) A	Height (mm) B	Length (mm) C	Cat. No. Brady	Quantity	Price
<b>Vinyl labels B-351</b>									
	814301	Labels	White	25.4	12.7	-	M71-17-351	500	N/A -
	814302	Labels	White	50.8	25.4	-	M71-20-351	100	N/A -
<b>Vinyl labels B-498</b>									
1	814324	Labels	White	19.05	25.4	-	M71-18-498	250	N/A -
1	167933	Label roll	White	25.4	9.5	-	M71-16-498	500	N/A -
1	167935	Label roll	White	25.4	12.7	-	M71-17-498	500	N/A -
1	167936	Label roll	White	25.4	25.4	-	M71-19-498	250	N/A -
<b>Polyester labels B-423</b>									
1	814305	Labels	White	19.05	6.35	-	M71-10-423	750	N/A -
1	814306	Labels	White	25.4	4.75	-	M71-14-423	750	N/A -
1	814307	Labels	White	25.4	25.4	-	M71-19-423	250	N/A -
1	814308	Labels	White	50.8	6.35	-	M71-2-423	100	N/A -
1	814309	Labels	White	12.7	5.08	-	M71-5-423	750	N/A -
1	814310	Labels	White	12.7	6.985	-	M71-6-423	750	N/A -
1	167995	Labels	White	38.1	25.4	-	M71-31-423	250	N/A -
1	167932	Label roll	White	25.4	9.5	-	M71-16-423	500	N/A -
1	167937	Label roll	White	38.1	12.7	-	M71-29-423	500	N/A -
1	167950	Label roll	White	25.4	12.7	-	M71-17-423	500	N/A -
1	167951	Label roll	White	50.8	25.4	-	M71-20-423	100	N/A -
<b>Polyester labels B-430</b>									
1	814312	Labels	Transp.	25.4	9.52	-	M71-16-430	500	N/A -
1	167934	Labels	Transp.	25.4	12.7	-	M71-17-430	500	N/A -
<b>Polyester labels B-461</b>									
7	814313	Labels	White	15.24	48.26	40	M71-107-461	500	N/A -
7	814314	Labels	White	25.4	66.68	25.4	M71-115-461	100	N/A -
7	814315	Labels	White	15.24	41.28	25.4	M71-76-461	500	N/A -
7	814316	Labels	White	15.24	66.68	15.24	M71-86-461	100	N/A -
<b>Polyester labels B-481</b>									
1	814317	Labels	White	22.86	22.86	-	M71-97-481	250	N/A -
<b>Polyester labels B-488</b>									
1	814318	Labels	White	48.26	6.35	-	M71-81-488	750	N/A -
1	814319	Labels	White	22.86	22.86	-	M71-97-488	250	N/A -
1	167953	Labels	White	19.05	22.86	-	M71-80-488	250	N/A -
<b>Polyester labels B-492</b>									
8	814321	Labels	White	25.4	12.7	9.53	M71-118-492	500	N/A -
1	814322	Labels	White	25.4	12.7	-	M71-17-492	500	N/A -
1	814323	Labels	White	48.26	25.4	-	M71-78-492	250	N/A -
1	770771	Labels	White	25.4	9.53	-	M71-16-492	500	N/A -
1	814250	Labels	White	25.4	25.4	-	M71-19-492	250	N/A -
<b>Nylon labels B-499</b>									
1	814325	Labels	White	12.7	19.05	-	M71-11-499	500	N/A -
8	814326	Labels	White	22.86	12.7	12.7	M71-126-499	500	N/A -
1	814327	Labels	White	19.05	25.4	-	M71-18-499	250	N/A -
1	814328	Labels	White	25.4	25.4	-	M71-19-499	250	N/A -
1	814329	Labels	White	25.4	63.5	-	M71-21-499	100	N/A -
1	814330	Labels	White	12.7	38.1	-	M71-29-499	500	N/A -
1	814331	Labels	White	19.05	38.1	-	M71-30-499	250	N/A -
1	814332	Labels	White	25.4	38.1	-	M71-31-499	250	N/A -
1	814333	Labels	White	48.26	6.35	-	M71-81-499	750	N/A -
1	814334	Labels	White	-	-	9.53	M71-82-499	500	N/A -
1	814335	Labels	White	-	-	12.7	M71-83-499	500	N/A -
1	167949	Labels	White	9.525	25.4	-	M71-16-499	500	N/A -
1	167952	Labels	White	48.26	25.4	-	M71-78-499	250	N/A -
1	167954	Labels	White	22.86	12.7	-	M71-84-499	500	N/A -
8	167955	Labels	White	12.7	19.05	9.53	M71-98-499	500	N/A -
<b>Freezerbondz labels B-490</b>									
1	814320	Labels	White	41.28	15.24	-	M71-76-490	500	N/A -
<b>Freezerbondz labels B-424</b>									
1	814311	Labels	White	50.8	25.4	-	M71-20-424	100	N/A -

TIP



See material selection guide on page 1247

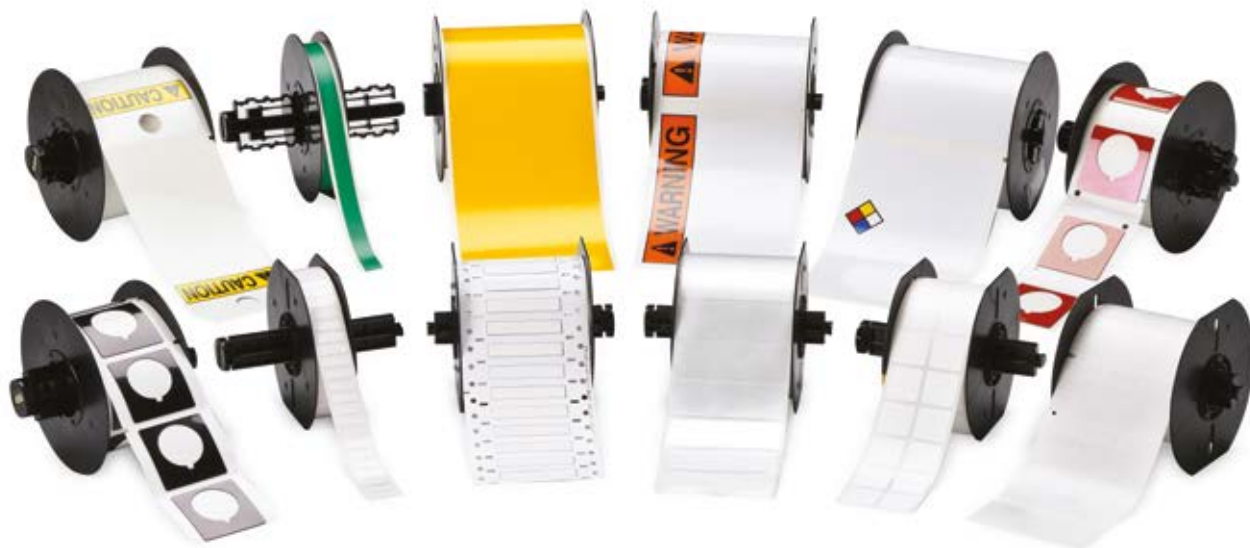

IDENTIFICATION, PROTECTION, WASTE MANAGEMENT

HEALTH AND SAFETY



## Brady M611 Printer



- ▶ Mobile printer with rechargeable lithium-ion battery
- ▶ Monochrome printing
- ▶ LCD colour touch screen
- ▶ Labels compatible with the M61 ink ribbons range
- ▶ Automatic label calibration (Smart Cell technology)
- ▶ Connectivity options: Bluetooth, USB, WIFI
- ▶ Software compatibility: Brady Workstation
- ▶ Print resolution: 300 dpi
- ▶ Print speed: up to 33.8 mm/s
- ▶ Label width: 6.4 to 50.8 mm
- ▶ Label height: 5.99 mm minimum
- ▶ Capacity: up to 750 labels/day
- ▶ Weight: 1.6 kg
- ▶ Printer supplied with USB cable, quick start guide, mains power cable, USB information stick, wrist strap, PTL-97-488 roll and M61-R4310 ink ribbon

Model	M611 Printer + LABS Suite
Cat. No.	834665
Price	N/A -

### Accessories

Cat. No.	Description	Price
834412	Magnets for M611	N/A -
834413	Hard carrying case for M611	N/A -
834414	Soft case for M611	N/A -

### Ribbons

Cat. No.	Description	Price
814438	Printer ribbon M61-R4310 (50.80 mm x 22.80 m)	N/A -
814449	Printer ribbon M61-R6010 (50.80 mm x 22.80 m)	N/A -
834679	Printer ribbon M61-R6410 (50.80 mm x 22.86 m)	N/A -

### Freezerbondz labels in B-492 material for M611 printer

- ▶ Adhesion on already frozen tubes (minimum application temperature: -196 °C)
- ▶ Operating temperature: -196 °C to +110 °C
- ▶ For use with R4300, R6400 range ribbons

Cat. No.	Model	Width (mm)	Height (mm)	Label Ø (mm)	Labels/roll	Price/roll
834691	M61-156-492	25.4	22.86	-	250	N/A -
834692	M61-120-492	25.4	12.7	9.525	250	N/A -
834693	M61-17-492	25.4	12.7	-	250	N/A -
834694	M61-19-492	25.4	25.4	-	250	N/A -
834695	M61-98-492	25.4	9.53	9.525	500	N/A -
834696	M61-117-492	22.86	12.7	12.7	500	N/A -
834697	M61-204-492	48.26	25.4	-	250	N/A -
834698	M61-130-492	9.53	20.96	-	500	N/A -
834699	M61-82-492	-	-	9.53	500	N/A -
834700	M61-83-492	-	-	12.7	500	N/A -
834701	M61-205-492	41.28	15.24	9.525	250	N/A -
834702	M61-203-492	44.45	25.4	-	250	N/A -
834703	M61-124-492	41.91	12.7	-	500	N/A -

**Labels and ribbons for TLS and M611 printers**

**Labels for TLS and M611 printers**

A: width; B: height; C: printable area

Cat. No.	Type	B x A (C) (mm)	Cat. No. Brady	Qty/ roll	Price
<b>Coverslips (fig. A)</b>					
167103	s	19.05 x 22.86	PTL-80-424	250	N/A -
167104	s	19.05 x 22.86	PTL-80-488	250	N/A -
167105	s	22.86 x 22.86	PTL-97-488	250	N/A -
167106	w	19.05 x 95.25 (25.40)	PTL-79-461	100	N/A -
<b>Microplates (fig. B)</b>					
167107	s	6.35 x 48.26	PTL-81-488	750	N/A -
167108	s	6.35 x 48.26	PTL-81-499	750	N/A -
167109	s	6.35 x 50.80	PTL-2-423	100	N/A -
<b>Straws (fig. C)</b>					
167110	w	25.40 x 25.40 (9.53)	PTL-19-427	250	N/A -
<b>Sealed bottles (fig. D)</b>					
167112	s	12.70 x 25.40	PTL-17-351	500	N/A -
167113	s	25.40 x 38.10	PTL-31-351	250	N/A -
167114	s	25.40 x 50.80	PTL-20-351	100	N/A -
167115	s	48.26 x 76.20	PTL-37-351	100	N/A -
<b>Microtubes 0.6 ml (fig. E)</b>					
167116	s	12.70 x 19.05	PTL-11-499	500	N/A -
167117	s	12.70 x 22.86	PTL-84-499	500	N/A -
167118	w	12.70 x 55.88 (19.05)	PTL-74-427	100	N/A -
167119	w	12.70 x 55.88 (19.05)	PTL-74-461	100	N/A -
<b>Microtubes 1.5/2 ml (fig. E)</b>					
167117	s	12.70 x 22.86	PTL-84-499	500	N/A -
167120	t	9.53 x 24.50 (ø 9.53)	PTL-98-499	500	N/A -
<b>Tube 4-8 ml (fig. E)</b>					
167121	w	15.24 x 66.68 (25.40)	PTL-86-461	100	N/A -
167122	w	25.40 x 66.68 (25.40)	PTL-75-427	100	N/A -
167123	w	25.40 x 66.68 (25.40)	PTL-75-461	100	N/A -
167124	w	25.40 x 66.68 (25.40)	PTL-75-461YL	100	N/A -
<b>Tubes 2-24 ml (fig. E)</b>					
167125	s	12.70 x 38.10	PTL-29-499	500	N/A -
167126	w	38.10 x 88.90 (31.75)	PTL-77-461	100	N/A -
<b>Microtube caps 0.5 ml (fig. F)</b>					
167127	w	ø 9.53	PTL-82-499	500	N/A -
167128	w	ø 9.53	PTL-82-499YL	500	N/A -
167120	s	9.53 x 24.50 (ø 9.53)	PTL-98-499	500	N/A -
<b>Microtube caps 1.5 ml to 2 ml (fig. F)</b>					
167129	w	ø 12.70	PTL-82-499	500	N/A -
167130	w	ø 12.70	PTL-82-499YL	500	N/A -
<b>0.5 ml microcentrifuge tubes (fig. G)</b>					
167116	s	12.70 x 19.05	PTL-11-499	500	N/A -
167117	s	12.70 x 22.86	PTL-84-499	500	N/A -
167131	s	9.53 x 25.40	PTL-16-499	500	N/A -
167120	s	9.53 x 24.50 (ø 9.53)	PTL-98-499	500	N/A -
167143	w	9.53 x 45.72 (19.05)	PTL-73-461	500	N/A -
167144	w	12.70 x 45.72 (19.05)	PTL-72-461	500	N/A -
167118	w	12.70 x 55.88 (19.05)	PTL-74-427	100	N/A -
167119	w	12.70 x 55.88 (19.05)	PTL-74-461	100	N/A -
<b>Centrifuge microtubes 1.5 to 2 ml (fig. G)</b>					
167116	s	12.70 x 19.05	PTL-11-499	500	N/A -
167132	w	15.24 x 41.28 (25.40)	PTL-76-461	250	N/A -
167118	w	12.70 x 55.88 (19.05)	PTL-74-427	100	N/A -
167119	w	12.70 x 55.88 (19.05)	PTL-74-461	100	N/A -
167121	w	15.24 x 66.66 (25.40)	PTL-86-461	100	N/A -
<b>15 ml culture tube (fig. H)</b>					
167126	w	38.10 x 88.90 (31.75)	PTL-77-461	100	N/A -
<b>50 ml tube, Petri dishes, microplates (fig. H)</b>					
167133	s	12.70 x 12.70	PTL-7-423	500	N/A -
167134	s	4.75 x 25.40	PTL-14-423	750	N/A -
167135	s	12.70 x 25.40	PTL-17-423	500	N/A -
167125	s	12.70 x 38.10	PTL-29-499	500	N/A -
167136	s	19.05 x 38.10	PTL-30-427AW	250	N/A -
167137	s	19.05 x 38.10	PTL-30-499	250	N/A -
167138	s	25.40 x 38.10	PTL-31-499	250	N/A -
167139	s	25.40 x 48.26	PTL-78-427AW	250	N/A -
167140	s	25.40 x 48.26	PTL-78-499	250	N/A -
167141	s	25.40 x 50.80	PTL-20-423	100	N/A -
167142	s	25.40 x 76.20	PTL-22-423	100	N/A -
<b>Cryotubes and centrifuge tubes (fig. I) - made of matt white polyester Freezer Bondz, suitable for identifying frozen tubes</b>					
167155	s	9.53 x 31.75	PTL-112-490	500	N/A -
167158	s	38.10 x 55.88	PTL-113-490	100	N/A -
167159	s	38.10 x 95.25	PTL-114-490	100	N/A -
167156	s	15.24 x 41.28	PTL-76-490	250	N/A -
167157	s	25.40 x 48.26	PTL-78-490	250	N/A -

**Adapter for PTL labels**

Cat. No.	Description	Price
814410	PTL adapter for BMP71 (3 units)	N/A -

**Tapes for TLS**

Cat. No.	Ribbon R-4310	Ribbon R-6010	Ribbon R-6210	Ribbon R-4410B blue	Ribbon R-4410R red	Ribbon R-4410W white
Cat. No.	167019	167020	167021	167022	167023	167024
Price	N/A -	N/A -	N/A -	N/A -	N/A -	N/A -

## Brady BBP12 Printer



- > 300 dpi colour LCD screen
- > Barcode type 1D (linear) and 2D
- > Stand-alone use with a connected keyboard and peripheral
- > Supports Zebra® and Eltron® programming language
- > Supplied with external feeder to print larger rolls of labels
- > Labels from 10 to 112 mm

Print resolution	300 dpi
Print speed	Up to 100 mm/s
Max. print width (mm)	105.6
Connectivity	USB 2.0, Ethernet as standard
Software compatibility	LabelMark, Codesoft, windows driver for third party software use
Weight (kg)	2.5
Dimensions (L x D x H) (mm)	202 x 258 x 173
BBP12 Printer + LABS Suite	<b>834667</b>
Price	N/A -

TIP



Labels for Brady BBP12 see page 1258



BBP12 with external support

### BBP12 Printer Ribbons

Cat. No.	Description	Price
804465	Printer ribbon wax/resin R-7950 110 mm x 70 m	N/A -
814492	Printer ribbon resin R-6000HF 110 mm x 70 m	N/A -
804778	Printer ribbon R-6400 110 mm x 70 m	N/A -
814042	Printer ribbon resin R-7950 65 mm x 70 m	N/A -
804777	Ribbon R-6400 65 mm x 70 m	N/A -

## Industrial printer i5100



- > Tabletop printer, high speed
- > Quick and easy setup
- > Printing on a continuous roll or on pre-cut labels
- > Wide range of labels and ribbons
- > Recognition of print media
- > Colour touch screen with remaining consumable quantity indication
- > Connectivity: USB, serial, Ethernet, Wi-Fi and Bluetooth options. Numerous standard ports allowing different industrial connection options
- > Available in 300 or 600 dpi resolution
- > Monochrome printing, up to 5000 labels/day
- > Print speed: up to 300 mm/s
- > Label width: 5 to 110 mm
- > Ribbon width: 9 to 112 mm
- > Consumables: IP ribbons and separate THT labels

### Ribbons for i5100

Cat. No.	Series	Material	Colours	Properties	Tape width	Price/ 300 m tape
834254	IP-R4300	Wax/resin	Black	Good resistance to dirt and chemicals; excellent readability	40 mm	N/A -
814041					60 mm	N/A -
0066027					83 mm	N/A -
167858					110 mm	N/A -
834255	IP-R4900	Resin	Black	High resistance to dirt, high temperature, solvents	60 mm	N/A -
168101					83 mm	N/A -
834257	IP-R6000HF	Resin	Black	Excellent resistance to solvents, heat and scratches. Halogen-free.	40 mm	N/A -
167907					60 mm	N/A -
834256					83 mm	N/A -
167859					83 mm	N/A -
834258	IP-R6100	Wax/resin	Black	Extra long life tape for general applications	60 mm	N/A -
834259					83 mm	N/A -
834260					110 mm	N/A -
834263	IP-R6200	Resin	Black	For harsh environments. Superior resistance to heat, abrasion and chemical attack	40 mm	N/A -
834261					60 mm	N/A -
834262					83 mm	N/A -
834264					110 mm	N/A -
0066236	IP-R6400	Resin	Black	Extreme temperature and chemical resistance, solvent resistance	60 mm	N/A -
167957					83 mm	N/A -
167906					40 mm	N/A -
167905					110 mm	N/A -

Model	Printer i5100 300 dpi + LABS suite
Cat. No.	834671
Price	N/A -

\* Printer supplied with: Power Supply Cable, USB Cable, Driver, User Manual, Configuration Manual, RFID Roll Holder, Ribbon Receiving Reel

TIP



See the material selection guide page 1247



Labels for Brady IP series and 5100 printers

THT labels on large mandrels

(\*external label holder option required)

A: width; B: height; C: printable area

Cat. No.	Type	B x A (C) (mm)	Cat. No. Brady	Qty/ roll	Price
<b>0.5 to 0.7 ml microcentrifuge tubes (fig. A)</b>					
167338	s	12.70 x 19.05	THT-68-499-10	10000	N/A -
167331	s	9.53 x 25.40	THT-152-499-3	3000	N/A -
167343	w	9.53 x 45.72 (19.05)	THT-123-461-3	3000	N/A -
167312	w	12.70 x 45.72 (19.05)	THT-123-461-3	3000	N/A -
167316	w	12.70 x 55.88 (19.05)	THT-127-427-3	3000	N/A -
167146	w	12.70 x 55.88 (19.05)	THT-127-461-3	3000	N/A -
<b>1.5 to 2 ml microcentrifuge tubes (fig. A)</b>					
167315	s	22.86 x 12.70	THT-126-499-3	3000	N/A -
167318	w	15.24 x 41.28 (25.40)	THT-133-461-3	3000	N/A -
167316	w	12.70 x 55.88 (19.05)	THT-127-427-3	3000	N/A -
167146	w	12.70 x 55.88 (19.05)	THT-127-461-3	3000	N/A -
167332	w	15.24 x 66.68 (25.40)	THT-153-461-3	3000	N/A -
167901	t	9.53 x 25.40 (Ø 9.53)	THT-163-499-3	3000	N/A -
<b>Conical tubes 14 to 15 ml (fig.B)</b>					
167319	w	38.10 x 88.90 (31.75)	THT-134-461-3	3000	N/A -
<b>Conical tubes / Bottles / Petri dishes / Microplates (fig.B)</b>					
167335	s	6.35 x 25.40	THT-51-423-10	10000	N/A -
167337	s	12.70 x 25.40	THT-5-423-10	10000	N/A -
167320	s	19.05 x 38.10	THT-135-427-AW-3	3000	N/A -
167321	s	19.05 x 38.10	THT-136-499-3	3000	N/A -
167322	s	25.40 x 50.80	THT-137-427-AW-3	3000	N/A -
167323	s	25.40 x 50.80	THT-137-499-3	3000	N/A -
167324	w	25.40 x 133.35 (38.10)	THT-139-461-2	2000	N/A -
<b>Tubes / Flasks 0.6 ml (fig.C)</b>					
167338	s	12.70 x 19.05	THT-68-499-10	10000	N/A -
167314	s	12.70 x 22.86	THT-125-499-3	3000	N/A -
167316	w	12.70 x 55.88 (19.05)	THT-127-427-3	3000	N/A -
167146	w	12.70 x 55.88 (19.05)	THT-127-461-3	3000	N/A -
<b>Tubes / Flasks of 1 to 2 mm (fig.C)</b>					
167315	t	22.86 x 12.70 (12.70)	THT-126-499-3	3000	N/A -
167318	w	15.24 x 41.28 (25.40)	THT-133-461-3	3000	N/A -
167332	w	15.24 x 66.68 (25.40)	THT-153-461-3	3000	N/A -
167317	w	25.40 x 66.68 (25.40)	THT-131-427-3	3000	N/A -
167261	w	25.40 x 66.68 (25.40)	THT-131-461-3	3000	N/A -
<b>Tubes / Flasks of 4 to 8 mm (fig.C)</b>					
167317	w	25.40 x 66.68 (25.40)	THT-131-427-3	3000	N/A -
167261	w	25.40 x 66.68 (25.40)	THT-131-461-3	3000	N/A -
<b>Tubes / Flasks of 12 to 24 mm (fig.C)</b>					
167319	w	38.10 x 88.90 (31.75)	THT-134-461-3	3000	N/A -
167324	w	25.40 x 133.35 (38.10)	THT-139-461-2	2000	N/A -
<b>Tube caps / 0.6 ml flasks (fig.D)</b>					
167328	l	(Ø 9.53)	THT-143-499-3	3000	N/A -
<b>Tube caps / 1 to 2 ml flasks (fig.D)</b>					
167329	l	(Ø 12.70)	THT-144-499-3	3000	N/A -
167315	x	22.86 x 12.70 (Ø 12.70)	THT-126-499-3	3000	N/A -
<b>Coverslips (fig. E)</b>					
167902****	s	22.86 x 22.86	THT-141-481-3	3000	N/A -
167903****	s	19.65 x 22.86	THT-194-481-3	3000	N/A -
167904****	s	9.53 x 22.86	THT-195-481-3	3000	N/A -
167325	s	19.05 x 22.86	THT-140-488-3	3000	N/A -
167326	s	22.86 x 22.86	THT-141-488-3	3000	N/A -
<b>Microplates (fig. F)</b>					
167333	s	6.35 x 50.80	THT-15-423-2.5	2500	N/A -
167330	s	6.35 x 50.80	THT-151-499-3	3000	N/A -
167327	s	5.08 x 63.50	THT-142-423-2.5	2500	N/A -
<b>Sealed flasks (fig. G)</b>					
167336	s	12.70 x 25.40	THT-5-351-10	10000	N/A -
167334	s	25.40 x 50.80	THT-17-351-3	3000	N/A -
<b>Microcentrifuge tubes (fig. H) in matt white polyester Freezer Bondz, suitable for identification of frozen tubes**</b>					
167160	s	9.53 x 31.75	THT-154-490-3	3000	N/A -
167161	s	15.24 x 41.28	THT-155-490-3	3000	N/A -
167162	s	25.40 x 48.26	THT-156-490-3	3000	N/A -
167163	s	38.10 x 55.88	THT-157-490-3	3000	N/A -
167164	s	38.10 x 95.25	THT-158-490-3	3000	N/A -
<b>Centrifuge microtubes (fig. H) Freezer Bondz, II suitable for identification of all frozen surfaces***</b>					
167853	l	9.53 mm	THT-143-492-3	3000	N/A -
167854	l	12.7 mm	THT-144-492-3	3000	N/A -
167365	s	48.26 x 25.4 mm	THT-156-492-3	3000	N/A -
167634	s	25.4 x 25.4 mm	THT-179-492-3	3000	N/A -
167635	s	22.86 x 22.86 mm	THT-180-492-3	3000	N/A -
167636	x	25.4 x 12.7 mm (Ø 9.53)	THT-181-492-3	3000	N/A -
167637	x	25.4 x 12.7 mm (Ø 12.18)	THT-182-492-3	3000	N/A -
167855	s	25.4 x 12.7 mm	THT-59-492-10	10000	N/A -
167974	-	25.40 x 19.05	THT-88-492-5	5000	N/A -
814347	-	41.28 x 15.24 (Ø 9.53)	THT-190-492-3	3000	N/A -
814348	-	41.28 x 15.24	THT-155-492-3	3000	N/A -
167632	-	25.40 x 9.53	THT-152-492-3	3000	N/A -
167634	-	25.40 x 25.40	THT-179-492-3	3000	N/A -
167633	-	25.40 x 9.53 (Ø 9.53)	THT-163-492-3	3000	N/A -

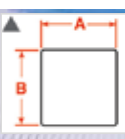
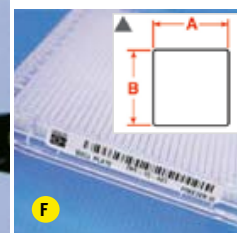
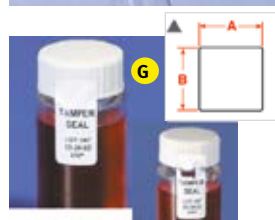
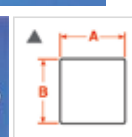
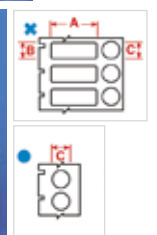
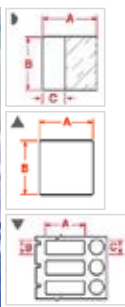
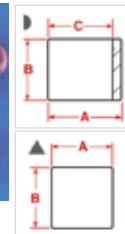
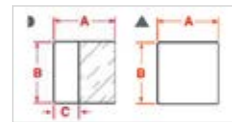

IDENTIFICATION, PROTECTION, WASTE MANAGEMENT

HEALTH AND SAFETY

\*\* Overlapping of both ends of the label is mandatory. \*\*\* No obligation to overlap the two ends of the label. \*\*\*\* Very high solvent resistance

## Labels for Brady BBP12, BBP11, BBP1344 printers

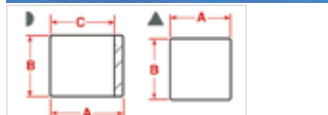
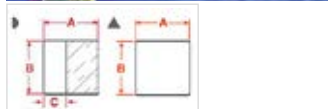
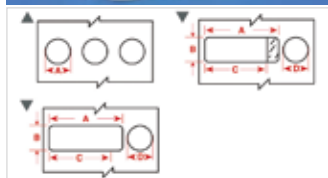

Cat. No.	Type	B x A (C) (mm)	Cat. No. Brady	Qty/ roll	Price
<b>Microtubes from 0.5 to 0.7 ml</b>					
167294	s	12.70 x 25.40	BPT-620-499	1000	N/A -
814052		12.70 x 55.90 (12.70)	THT-127-461-1.5-SC	1500	N/A -
167173	t	9.53 x 25.40 (9.53) Ø 9.53	BPT-606-461	1000	N/A -
804788		25.40 x 9.53	THT-152-492-2.5-SC	2500	N/A -
804786		25.40 x 25.40	THT-179-492-2.5-SC	2500	N/A -
814070		9.50 x 45.70 (12.70)	THT-123-461-1.5-SC	1500	N/A -
814071		12.70 x 45.70 (9.50)	THT-122-461-1.5-SC	1500	N/A -
167290	w	5.08 x 22.86 (18)	BPT-614-461	2000	N/A -
167298	w	6.35 x 27.94 (22)	BPT-627-461	1000	N/A -
814073		31.75 x 9.53	THT-154-490-1.5-SC	1500	N/A -
<b>Tubes from 0.5 to 8 ml</b>					
814054		25.40 x 9.53 x Ø 9.53	THT-249-492-1.5-SC	1500	N/A -
814055		25.40 x 9.53 x Ø 9.53	THT-249-499-1.5-SC	1500	N/A -
814056		25.40 x 12.70 x Ø 9.53	THT-250-492-1.5-SC	1500	N/A -
814057		25.40 x 12.70 x Ø 11.18	THT-251-492-1.5-SC	1500	N/A -
<b>0.6 ml Microtubes</b>					
814058		22.90 x 12.70	THT-125-499-1.5-SC	1500	N/A -
<b>Microtubes from 0.6 to 1.5 ml</b>					
814075		Ø 9.53	THT-143-492-1.5-SC	3000	N/A -
<b>Microtubes 0.6 to 50 ml</b>					
167280	s	Ø 9.53	BPT-602-461-AW	3000	N/A -
167281	s	Ø 9.53	BPT-602-499	3000	N/A -
167282	s	Ø 9.53	BPT-602-499-YL	3000	N/A -
167283	s	Ø 12.70	BPT-603-499	3000	N/A -
167284	s	Ø 12.70	BPT-603-499-YL	3000	N/A -
167285	s	Ø 15.24	BPT-604-461-AW	3000	N/A -
<b>Microtubes 1 to 2 ml</b>					
167289	w	15.24 x 66.68 (25.40)	BPT-612-461	1500	N/A -
167300	w	15.24 x 38.10 (33)	BPT-628-461	2500	N/A -
167277		15 x 40 x 30 x Ø 9	BPTLAB-20-461-2	2500	N/A -
167174	t	15.24 x 41.28 (15.24) x Ø 12.70	BPT-608-461	1000	N/A -
167286	w	15.24 x 51.28 x Ø 12.70	BPT-608-499	1000	N/A -
814076		Ø 12.70	THT-144-492-1.5-SC	1500	N/A -
814069		Ø 12.70	THT-144-499-1.5-SC	1500	N/A -
<b>Tubes from 1 to 8 ml</b>					
167948		25.40 x 19.10	THT-88-492-2.5-SC	2500	N/A -
814059		41.28 x 15.24	THT-155-490-1.5-SC	1500	N/A -
814074		48.26 x 25.40	THT-156-490-1.5-SC	1500	N/A -
814060		48.26 x 25.40	THT-156-492-1.5-SC	1500	N/A -
814061		66.68 x 25.4	THT-131-461-1.5-SC	1500	N/A -
<b>Microtubes 1.5 to 2 ml</b>					
814062		15.20 x 41.30 (15.20)	THT-133-461-1.5-SC	1500	N/A -
814063		15.20 x 66.70 (25.40)	THT-153-461-1.5-SC	1500	N/A -
814064		25.40 x 12.70	THT-59-492-2.5-SC	2500	N/A -
<b>Tubes from 2 to 4 ml</b>					
167304	w	15.24 x 48.26 (40)	BPT-638-461	2000	N/A -
<b>Tubes from 4 to 8 ml</b>					
167297	s	25.40 x 66.68	BPT-625-499	2000	N/A -
<b>Tubes from 4 to 50 ml</b>					
167301	w	34.93 x 45.72 (40)	BPT-632-461	2000	N/A -
<b>Tubes from 12 to 24 ml</b>					
814065		55.88 x 38.10	THT-157-490-1.5-SC	1500	N/A -
<b>14/15 ml conical tubes</b>					
167308	s	38.10 x 88.90	BPT-650-461-AW	3000	N/A -
<b>Conical tubes / Bottles / Petri dishes / Microplates</b>					
167288	s	12.70 x 25.40	BPT-611-499	3000	N/A -
167293	s	22.86 x 38.10	BPT-618-499	3000	N/A -
814066		25.40 x 12.70	BPT-659-498	1000	N/A -
167296	s	25.40 x 36.50	BPT-621-499	3000	N/A -
167299	w	19.05 x 38.10 (33)	BPT-629-461	2500	N/A -
167303	s	25.40 x 48.26	BPT-636-461-AW	2000	N/A -
167305	s	38.10 x 55.88	BPT-640-427-AW	2000	N/A -
167306	s	19.05 x 57.15	BPT-642-461-AW	2000	N/A -
167307	s	25.40 x 66.68	BPT-648-427-AW	2000	N/A -
<b>Microplates</b>					
167310	s	19.05 x 38.10	BPT-6-8423-2.5	2500	N/A -
167302	s	6.35 x 48.26	BPT-635-488	2000	N/A -
<b>Coverslips</b>					
167168	s	19.05 x 22.86	BPT-616-488	3000	N/A -
167292	s	22.86 x 22.86	BPT-617-488	3000	N/A -

IDENTIFICATION, PROTECTION, WASTE MANAGEMENT

HEALTH AND SAFETY



THT labels on large mandrel see previous page (1257)

## Brady i3300 Printer

The i3300 thermal transfer printer can print on a full range of materials for safety and facility identification labels as well as pre-cut labels for wire, product or laboratory equipment identification.

- Self-calibration, automatic media recognition, consumable replacement in 20 seconds
- PC connectable with LabelMark software
- USB and Ethernet ports, WIFI connection

- 300 dpi resolution
- Colour touch screen
- Dust reduction thanks to filter pads



Cat. No.	Description	Price
834415	i3300 Printer + LABS Suite	N/A -

### Printer ribbons

Cat. No.	Description	Price
814193	Printer ribbon B30-R4300	N/A -
814194	Printer ribbon B30-R6000	N/A -
814195	Printer ribbon B30-R6400	N/A -
814196	Printer ribbon B30-R6200	N/A -



See the material selection guide page 1247

### Labels for i3300 and BBP 33 models

Cat. No.	Type	Colour	Type	Cat. No. Brady	Dim. A (mm)	Dim. B (mm)	Dim. C (mm)	Dim. D (mm)	Quantity	Price
<b>Nylon labels B-499</b>										
814197	Made of nylon fabric	White	1	B33-143-499	9.53	-	12.10	12.70	1500	N/A -
814198	Made of nylon fabric	White	1	B33-144-499	12.70	-	12.10	12.70	1500	N/A -
814199	Made of nylon fabric	White	4	B33-68-499	12.70	19.05	15.20	22.20	1500	N/A -
814200	Made of nylon fabric	White	4	B33-152-499	25.40	9.53	27.94	12.07	1500	N/A -
814202	Made of nylon fabric	White	5	B33-125-499	22.86	12.70	-	-	1500	N/A -
814203	Made of nylon fabric	White	5	B33-659-499	25.40	12.40	-	-	1000	N/A -
814204	Made of nylon fabric	White	5	B33-151-499	50.80	6.35	-	-	1500	N/A -
814205	Made of nylon fabric	White	5	B33-136-499	38.10	19.05	-	-	1500	N/A -
814206B	Made of nylon fabric	White	9	B33-137-499	-	-	-	-	1100	N/A -
<b>Freezerbondz 2 polyester labels</b>										
814207	For cryogenics	White	1	B33-143-492	9.53	-	12.06	12.70	1500	N/A -
814208	For cryogenics	White	1	B33-144-492	12.70	-	15.24	15.88	1500	N/A -
814209	For cryogenics	White	6	B33-163-492	25.40	9.53	9.53	-	1500	N/A -
814211	For cryogenics	White	6	B33-182-492	25.40	12.70	11.18	-	1500	N/A -
814212B	For cryogenics	White	5	B33-59-492	25.40	12.70	-	-	2500	N/A -
814213	For cryogenics	White	5	B33-180-492	22.86	25.40	-	-	1500	N/A -
814214B	For cryogenics	White	5	B33-179-492	25.40	25.40	-	-	1900	N/A -
814210	For cryogenics	White	6	B33-181-492	25.40	12.7	9.53	-	1500	N/A -
814248	For cryogenics	White	4	B33-152-492	25.40	9.53	-	-	2500	N/A -
814215	For cryogenics	White	5	B33-156-492	48.26	25.40	-	-	1500	N/A -
<b>Polyester labels B-492</b>										
814345	Labels	White	-	B33-190-492	41.28	15.24	9.53	-	1500	N/A -
814346	Labels	White	-	B33-155-492	41.28	15.24	-	-	1500	N/A -
<b>Polyester labels B-481</b>										
814242B	Labels	White	-	B33-194-481	22.86	19.05	22.23	27.94	2000	N/A -
<b>Polyester labels</b>										
814216	For smooth surfaces	White	4	B33-5-423	25.40	12.70	27.30	15.20	5000	N/A -
814217	For smooth surfaces	White	5	B33-17-423	50.80	25.40	-	-	1500	N/A -
814218	For smooth surfaces	White	5	B33-18-423	76.20	25.40	-	-	1500	N/A -
814219	For smooth surfaces	Transp.	5	B33-17-430	50.80	25.40	-	-	1500	N/A -
814220	For smooth surfaces	Transp.	5	B33-18-430	76.20	25.40	-	-	1500	N/A -
814221	For rough surfaces	White	4	B33-5-483	25.40	12.70	27.30	15.20	5000	N/A -
814222	For rough surfaces	White	5	B33-17-483	50.80	25.40	-	-	1500	N/A -
814223	For rough surfaces	White	5	B33-18-483	76.20	25.40	-	-	1500	N/A -
814224	For rough surfaces	White	5	B33-19-483	76.20	50.80	-	-	500	N/A -
814225	For rough surfaces	White	5	B33-635-488	48.26	6.35	-	-	2000	N/A -
<b>Self-protected polyester labels B-461</b>										
814230	With transparent label	White	7	B33-614-461	22.86	5.08	-	-	2000	N/A -
814231	With transparent label	White	7	B33-627-461	27.94	6.35	-	-	1000	N/A -
814232	With transparent label	White	2	B33-606-461	25.40	9.53	-	-	1000	N/A -
814233	With transparent label	White	7	B33-123-461	45.72	9.53	-	-	1500	N/A -
814234	With transparent label	White	7	B33-122-461	45.72	12.70	-	-	1500	N/A -
814235	With transparent label	White	8	B33-133-461	15.24	41.28	17.78	46.99	1500	N/A -
814236	With transparent label	White	3	B33-608-461	41.28	15.24	12.70	-	1000	N/A -
814237	With transparent label	White	8	B33-127-461	12.70	55.88	15.24	61.60	1500	N/A -
814238	With transparent label	White	7	B33-153-461	66.68	15.24	-	-	1500	N/A -
814239	With transparent label	White	7	B33-276-461	66.68	25.40	-	-	1500	N/A -
814240	With transparent label	White	8	B33-139-461	25.40	133.35	27.94	136.52	650	N/A -
814241	With transparent label	White	7	B33-134-461	88.90	38.10	-	-	1000	N/A -
<b>White vinyl labels B-498</b>										
814226	In vinyl fabric	White	4	B33-1-498	19.05	6.35	20.30	9.80	5000	N/A -
814227	In vinyl fabric	White	4	B33-5-498	25.40	12.70	27.30	15.20	5000	N/A -
814228	In vinyl fabric	White	4	B33-88-498	25.40	19.05	27.90	22.20	2500	N/A -
814229B	In vinyl fabric	White	4	B33-89-498	25.40	36.50	27.90	39.70	2300	N/A -

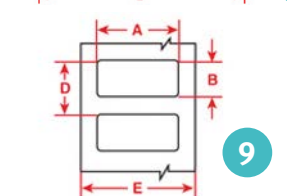
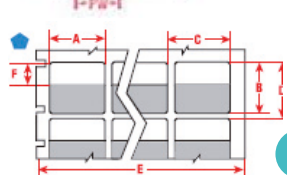
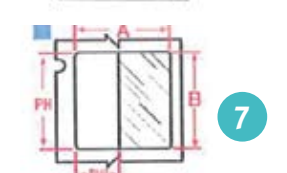
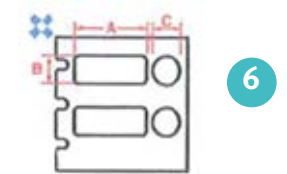
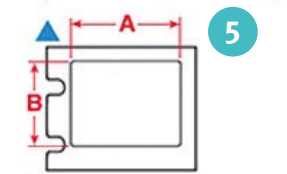
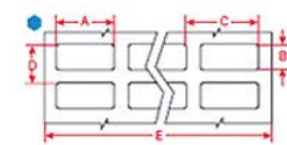
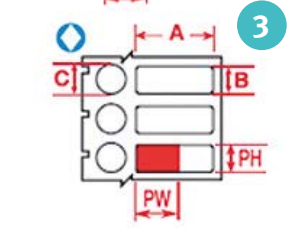
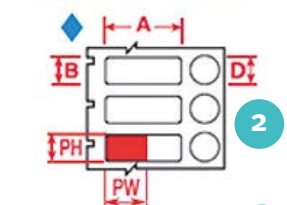
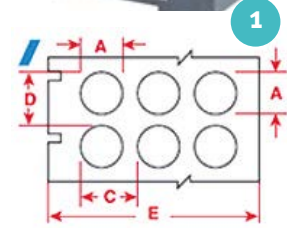



## BradyJet J2000 Printer



- ▶ High resolution 4800 dpi colour inkjet printing
- ▶ Automatic label configuration
- ▶ Quick replacement of label rolls
- ▶ Labels resistant to -196 °C and boiling water bath or autoclave; resistant to chemicals such as ethanol, methanol, toluene, acetone, xylene, isopropanol, DMSO
- ▶ For indoor display
- ▶ Dimensions: 26.4 x 38.9 cm
- ▶ Weight: 3.20 kg
- ▶ Minimum label length: 6.35 mm
- ▶ Label width: 19 to 101.60 mm
- ▶ Printing up to 3000 labels/day and 63 mm/second
- ▶ Connectivity: USB
- ▶ Printer supplied with power cable, AC adapter, USB cable, start-up guide, ink cartridge, label roll for print head alignment

### Labels in PP B-7425J

Cat. No.	Width (mm)	Height (mm)	Diameter (mm)	Labels/roll	Price/roll
834375	20.96	6.35	-	1500	N/A -
834379	50.8	6.35	-	2000	N/A -
834373	25.4	9.53	-	2000	N/A -
834391	25.4	9.53	9.53	1500	N/A -
834374	25.4	12.7	-	2000	N/A -
834401	25.4	12.7	11.18	1500	N/A -
834388	38.1	12.7	-	1500	N/A -
834392	50.8	12.7	-	2000	N/A -
834384	33.02	15.24	-	1500	N/A -
834383	25.4	19.05	-	2000	N/A -
834387	38.1	19.05	-	1500	N/A -
834393	25.4	25.4	-	1500	N/A -
834390	38.1	25.4	-	1250	N/A -
834386	50.8	25.4	-	1500	N/A -
834396	38.1	44.45	-	900	N/A -

Model	J2000 printer with lab workstation suite
Cat. No.	834368
Price	N/A -

### Accessory

Cat. No.	Description	Price
834402	CMY colour ink cartridge for J2000	N/A -



## i 7100 Printer with automatic label applicator



Increase efficiency with the automatic tube labelling module.

- ▶ For accurate and durable high volume printing
- ▶ Powerful internal processor: up to 7000 labels/day
- ▶ Print speed: up to 300 mm/s
- ▶ 300 dpi print resolution
- ▶ Wide range of high quality identification consumables
- ▶ Intuitive colour touch screen

Cat. No.	Description	Price
834772	i 7100 300 dpi printer with LABS suite and automatic label applicator	N/A -



## XENON 1950G HD barcode reader

- Wired barcode reader
- Superior reading performance even on damaged codes or phone screens
- Shock resistant
- Protection from water and dust: IP41 rating
- Lightweight: 160 g
- 5 year warranty

Cat. No.	Description	Price
834706	Xenon 1950G HD handheld barcode scanner	N/A -

### Hands-free holder

Cat. No.	Description	Price
834794	Stand for XENON 1950G reader	N/A -



## Label sheets for laser printers

A: width; B: height; C: printable area

Cat. No.	B x A (C) (mm)	Properties	Label/ Folios	Label/ box	Price/ box
<b>For centrifuge tubes, PCR, 0.5 to 0.7 ml</b>					
167871	12.7 x 19.05 mm	F N A	156	1000	N/A -
167872	25.4 x 9.53 mm	F N A	175	10000	N/A -
167874	9.53 x 45.72 mm (Ø 19.05)	F N A H L S	100	2500	N/A -
<b>For centrifuge tubes, PCR, 1.2 to 2 ml</b>					
167873	15.24 x 41.28 mm (Ø 25.40)	F N A H L S	64	2500	N/A -
167876	15.24 x 66.04 mm (Ø 25.40)	F N A H L S	64	2500	N/A -
<b>For 1 to 8 ml tubes</b>					
167875	25.4 x 66.68 mm (Ø 25.40)	F N A H L S	21	1000	N/A -
<b>For tube cap</b>					
167877	9.52 mm Ø	F N A	285	2500	N/A -
<b>For 50 ml conical tubes, bottles, Petri dishes, tube trays</b>					
167880	36.50 x 25.4 mm	F N A	42	2500	N/A -
<b>For tube trays</b>					
167881	6.35 x 47.63 mm	F A	156	10000	N/A -

- For any desktop laser printer
- For use with Brady Workstation suite LABS

	Application key
F	Freezer (- 80 °C)
N	Liquid nitrogen (- 196 °C)
A	Autoclave
H	Water baths (100 °C)
L	Ultra-thin label
R	Repositionable adhesive
S	Self-protecting label

## Safety lighting

- Suitable for use in ATEX zones
- Phthalate-free, non-toxic, non-flammable

### Light sticks 150 mm

- Visible up to 1.6 km away
- Hanging ring
- Fold and shake to activate
- Packaged individually

Duration	8 hrs	
Colours	Blue	White
Cat. No.	231033	231034
Price	N/A -	N/A -



## Absorbent protection paper on rolls



Economical "examination sheet" type paper with an absorbent wadding side and a waterproof side.

- **Width: 50 cm**
- **Pre-cut in 38 cm sizes, 180 sizes per roll**
- **White**
- **Wrapped in plastic film**

Cat. No.	Description	Price
030640	Roll of absorbent paper "examination sheet"	N/A -
002985	Examination sheet dispenser 50 cm wide	N/A -

## Benchkote™ bench top protection paper



Absorbent and impermeable paper for the protection of laboratory surfaces from leakage of hazardous substances.

- **One side of laminated polyethylene to capture deposits without absorption, another side of paper that quickly absorbs liquids to prevent them from spilling onto the work surface**
- **Thicker, more absorbent Benchkote Plus version for more demanding applications (up to 0.75 l of water absorbed per m<sup>2</sup>)**
- **Extremely robust**
- **Very easy collection and incineration after use**

### ➤ Applications

- Control of radiochemical leaks, prevention of contamination
- Recovery of inadvertently spilled valuable materials
- Regulation of the atmosphere (water or solvent) in wet rooms
- Covering of chemical equipment walls, bench drawers and laboratory hoods

Cat. No.	Type	Presentation	Packaging	Price
036102	Benchkote	Sheets 46 x 57 cm	50 sheets	N/A -
034994	Benchkote	Sheets 46 x 57 cm	100 sheets	N/A -
036103	Benchkote	Sheets 46 x 52 cm	50 sheets	N/A -
036104	Benchkote	Roll 46 cm x 50 m	1 roll	N/A -
036105	Benchkote	Roll 92 cm x 50 m	1 roll	N/A -
036106	Benchkote Plus	Sheets 50 x 60 cm	50 sheets	N/A -
036107	Benchkote Plus	Roll 60 cm x 50 m	1 roll	N/A -

## Bench top protection papers



- **Material: 80% cellulose, 20% polyethylene film**
- **Protection against shocks, acids and corrosive environments, radiochemicals**
- **Recovery of materials after calcination**
- **Weight: 125 g/m<sup>2</sup>, sheet or roll**

Cat. No.	Presentation	Dimensions (mm)	Units/box	Price/box
074129	Sheet	420 x 520	100	N/A -
074130	Sheet	460 x 570	100	N/A -
074131	Sheet	500 x 600	100	N/A -
074132	50 m roll	Width: 460	1	N/A -
074133	50 m roll	Width: 600	1	N/A -
074134	50 m roll	Width: 490	1	N/A -
074128	50 m roll	Width: 920	1	N/A -

## Labmat protection papers



Absorbent paper lined with waterproof polyethylene film. The absorbent side retains all solutions, water, dyes, buffers, aggressive or radioactive chemical solutions. The orange model is ideal for biohazardous areas.

Cat. No.	Description	Price the roll
085007	Labmat roll, white 50 cm x 15 m	N/A -
085008	Labmat roll, orange 50 cm x 15 m	N/A -





## Versi-dry bench top protection papers

- Absorbent papers with polyethylene back
- Liquid absorbed (depending on model): 750 ml/m<sup>2</sup> or 1050 ml/m<sup>2</sup>
- In rolls, dispenser rolls or sheets.

Cat. No.	Presentation	L x W	Packaging unit	Price
<b>Versi-dry absorbance standard white (750 ml/m<sup>2</sup>)</b>				
029152	Dispenser roll	100 m x 51 cm	1 roll	N/A -
088025	Dispenser roll	30 m x 51 cm	4 rolls	N/A -
029153	Roll	100 m x 51 cm	2 rolls	N/A -
029154	Roll	50 m x 51 cm	2 rolls	N/A -
029155	Sheets	46 cm x 51 cm	350 sheets	N/A -
<b>Versi-dry blue enhanced absorbency (1050 ml/m<sup>2</sup>)</b>				
029157	Roll	80 m x 51 cm	1 roll	N/A -
029156	Sheets	45 cm x 51 cm	350 sheets	N/A -



## BenchGuard bench top protection papers

- Protection of worktops
- One side waterproof and one side capable of adsorbing 400 ml/m<sup>2</sup>
- BenchGuard Extra for 800 ml/m<sup>2</sup> absorption
- Available in 60 cm x 49 cm sheets or 50 m rolls

Cat. No.	Description	Sheet or roll size	Units/box	Price/box
090275	BenchGuard	50 m x 49 cm	1 roll	N/A -
090276B	BenchGuard	60 cm x 49 cm	100 sheets	N/A -
090277	BenchGuard Extra	50 m x 49 cm	1 roll	N/A -
090278	BenchGuard Extra	60 cm x 49 cm	50 sheets	N/A -



## Laboratory set

- In silicone (VMQ)
- Withstands up to + 260 °C
- Non-slip
- Sterilizable



Colour	W x L (mm): 250 x 250	W x L (mm): 350 x 350
Red	092156	092158
Black	092157	092159
Price	N/A -	N/A -

## Silicone protection mat



- In silicone (FDA)
- Dimensions: 35 x 60 cm
- Thickness: 2 mm
- Autoclavable at 121 °C for 15 minutes
- Easy to clean with standard disinfectant; can also be put in the dishwasher
- Protects the bench from hot samples up to 200 °C
- Temperature resistant from -50 °C to 200 °C

Cat. No.	Side 1	Side 2	Price
320552	Yellow	Blue on grey background	N/A -
320553	Violet	Grey on purple background	N/A -
320623	Blue	White with blue border	N/A -

## Sterile 3-ply towel

- Non-adhesive
- Absorbent (nonwoven) and waterproof (polyethylene)

Cat. No.	Dimensions W x L (cm)	Number of layers	Units/box	Price/box
711736	75 x 90	2	6 x 38	N/A -
711737	90 x 150	3	2 x 30	N/A -
711738	150 x 240	3	24 x 2	N/A -

## Protective mat



- Ideal for environments where sterility is required
- 2 sides:
  - 1 smooth side
  - 1 rough side: prevents movement of small objects, slipping of tanks, tip boxes and other consumables
- Keeps the bench clean and free of dirt and wear
- Reusable
- Edge to hold up to 250 ml
- Anti-slip
- Reduces vibration noise from small equipment such as microcentrifuges
- Easy cleaning with standard disinfectant, dishwasher safe
- Resistant to most chemicals
- Protects the bench from hot containers up to 200 °C
- Dimensions: 305 x 379 x 2 mm
- Autoclavable at 121 °C for 15 minutes

Blue	Violet	Price
320702	320703	N/A -

## Retention bins

### Polypropylene drip tray



Polypropylene drip tray

- > For corrosive products, high strength products
- > Can be used without a grate

Cat. No.	Dim. H x W x D (mm)	Storage Capacity		Retention capacity(l)	Weight (kg)	Price
		1 l bottle	2 l bottle			
060076	85 x 455 x 480	18	9	11	5	N/A -

### 8-litre retention lab with grating



- > Ideal for handling hazardous materials in the laboratory
- > Roto-moulded high density polyethylene mono block
- > Green, dyed in the mass, UV treated
- > Food grade, rot-proof, inert to many chemicals
- > ISO 9002 Certified
- > H x W x L: 70 x 400 x 600 mm

Cat. No.	Description	Price
322000	Lab retention tray 8 litres without grating	N/A -
322001	Gratings	N/A -

### > General characteristics

- > Fast and secure storage during handling
- > Holds liquids at the bottom of the tank in case of a leak
- > Easy to clean
- > Edge to hold stored containers in place

### Steel retention tray



Steel retention tray

- > For toxic, noxious and polluting products, delivered without grating
- > To be completed with a grating model 060291B and 060198B

Cat. No.	Dim. H x W x D (mm)	Storage Capacity		Retention capacity(l)	Weight (kg)	Price
		1 l bottle	2 l bottle			
060274B	30 x 490 x 410	16	9	6	3	N/A -
060276B	30 x 1000 x 410	36	20	12	2	N/A -
060290B	100 x 1000 x 410	36	2	20	41	N/A -
060294B	100 x 480 x 410	16	9	20	5	N/A -

### Gratings for steel tray

- > The grating Cat. No. 060291B reduces the retention capacity of the tray by 6 l
- > The grating Cat. No. 060198B reduces the retention capacity of the tray by 3 l

Cat. No.	For tray Cat. No.	Dim. H x W x D (mm)	Storage Capacity		Weight (kg)	Price
			1 l bottle	2 l bottle		
060291B	060290B	90 x 990 x 400	36	2	3	N/A -
060198B	060294B	90 x 480 x 400	16	9	2	N/A -

### Accessory

Cat. No.	Description	Price 10 units
060070	Absorbent sheet mats	N/A -

## Retention bins in HDPE



001047B



212025

- > Approved for food contact, HACCP
- > Empty nestable, stackable with lid
- > Use -40 °C to +90 °C
- > HDPE grids (-40 °C to +90 °C)
- > Transparent polypropylene lids (-20 °C to +90 °C)

### 8 l bins

	Dimensions L x W x H (mm)	Weight (kg)	White	Red	Blue	Green	Yellow	Price
Tray	485 x 335 x 75	0.65	001047B	212021B*	212022B*	212023B*	212024B*	N/A -
Grid	420 x 270 x 8	0.17	212025	-	-	-	-	N/A -
Lid	490 x 340	0.31	211967	-	-	-	-	N/A -

\* with HACCP traceability label

### 8 l bin + grid + lid

Colours	White	Red	Blue	Green	Price
Cat. No.	212026B	212027B	212028B	212029B	N/A -

### 10 l bins - white

Cat. No.	Type	Dimensions L x W x H (mm)	Weight (kg)	Price
001048	Tray	535 x 385 x 80	0.81	N/A -
212034	Grid	470 x 320 x 8	0.21	N/A -

## Retention bins

### Plastic retention trays

- For small packaging
- Optimised dimensions for European pallets
- With or without gratings



Volume (l)	Dimensions (mm)	Gratings	Cat. No.	Price
7	200 x 400 x 120	No	571397	N/A -
		Yes (galvanised steel)	571398	N/A -
		Yes (plastic steel)	571399	N/A -
15	400 x 400 x 120	No	571400	N/A -
		Yes (galvanised steel)	571401	N/A -
		Yes (plastic steel)	571402	N/A -
32	400 x 800 x 120	No	571403	N/A -
		Yes (galvanised steel)	571404	N/A -
		Yes (plastic steel)	571405	N/A -
68	800 x 800 x 120	No	571406	N/A -
		Yes (galvanised steel)	571407	N/A -
		Yes (plastic steel)	571408	N/A -

### Smartsafe steel retention bins



- Complies with the order of 4 October 2010
- Authorised for the storage of flammable liquids
- Made of 2 mm thick welded steel

Storage capacity in 200 litre drums	4	8
Storage capacity in 1000 litre drums	1	2
Retention Volume (l)	1100	1230
Dimensions (mm)	1285 x 1300 x 864	2564 x 1290 x 487
Version	Galvanised	Galvanised
<b>Cat. No.</b>	<b>571424</b>	<b>571425</b>
<b>Price</b>	<b>N/A -</b>	<b>N/A -</b>

## Retention trays and pallets

- Made of polyethylene
- High chemical resistance
- Easy to clean
- Removable grating with yellow anti-slip surface
- Pallet with fork passage
- Pallet for 2 x 200 l drums: with lockable sliding door

Cat. No.	Retention capacity (l)	Gratings	Dimensions H x L x D (mm)	Load capacity (kg)	Price
060283	20	No	155 x 600 x 400	50	N/A -
060277		Yes			N/A -
960360	30	No	155 x 805 x 405	50	N/A -
060278		Yes			N/A -
960513	40	No	155 x 800 x 600	100	N/A -
960404		Yes			N/A -
960382	60	No	175 x 1000 x 600	200	N/A -
060381		Yes			N/A -
960312	100	No	172 x 1200 x 800	200	N/A -
960313		Yes			N/A -
960521	250*	Yes	2110 x 1565 x 995	650	N/A -
960405	1100**	Yes	1000 x 1450 x 1450	2000	N/A -

\* Covered retention pallet for 2 x 200 litre drums.

\*\* Retention pallet for 1000 litre cube.





## Clip-on gratings in HDPE



- ▶ Insulating and non-slip, good mechanical strength
- ▶ Easy to clean: water jet, high pressure cleaner, machine
- ▶ Optimal fluid removal
- ▶ Simple, scalable installation
- ▶ Use: -40 °C to +90 °C
- ▶ Dimensions: 500 x 500 mm

Thickness (mm)	Weight (kg)	White	Red	Blue	Green	Yellow	Price
22	1.02	212059	212060	212061	212062	212063	N/A -
50	2.16	212064	-	-	-	-	N/A -

## Bench top protection trays

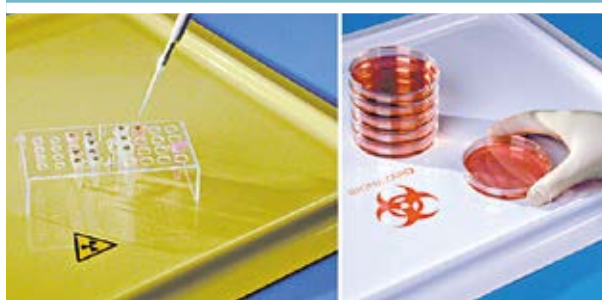

- ▶ PVC, with raised edges to delimit the work area and contain spills
- ▶ Available in white, white with biohazard pictogram or yellow with radioactivity pictogram
- ▶ Can be used with disposable APET liner

Dimensions (mm)	460 x 260		540 x 340		570 x 540		1130 x 540	
Colours/inscriptions	Cat. No.	Price	Cat. No.	Price	Cat. No.	Price	Cat. No.	Price
White	263231	N/A -	263240	N/A -	263232	N/A -	263233	N/A -
White "BioHazard"	263228	N/A -	263243	N/A -	263229	N/A -	263230	N/A -
Yellow "Radioactivity"	263234	N/A -	263245	N/A -	263235	N/A -	263236	N/A -
Protective liner (per 25)	263225	N/A -	263242	N/A -	263226	N/A -	263227	N/A -

## Anti-splash trays for bench top



- ▶ Made of chemical-resistant polyethylene
- ▶ Transparent sidewalls: easy to spot leaks
- ▶ Removable grid
- ▶ Spout for quick and easy draining
- ▶ Compact: fits on a bench, counter or worktop

Cat. No.	Ext. dimension (mm)	Capacity (l)	Price
333200	420 x 300 x 100	5.6	N/A -
333201	520 x 420 x 100	11.3	N/A -

## Anti-beta waste containers



Waste containers that can hold:

- the 20 litre Nalgene bottles (large model);
- the 10 litre bottles (small model);
- as well as cardboard waste boxes.

Cat. No.	Description	L x W x H (mm)	Price
028033	Anti-beta acrylic container for waste box small model	330 x 330 x 432	N/A -
028689	Anti-beta acrylic container for large waste box	457 x 457 x 737	N/A -

## Waste box for radioactive pipette tips

Acrylic box for the recovery of radioactive tips.

Clear acrylic for beta rays [<sup>32</sup>P]

- Top lid with hinges
- Hatch in the lid for the insertion of tips
- Complete with bags printed with the "Radioactive" pictogram



Cat. No.	Description	L x W x H (mm)	Price
037929	Anti-beta box	154 x 171 x 206	N/A -

## Protective containers

Acrylic waste containers, supplied with a 2 litre Nalgene bottle. Thickness: 9 mm.



Cat. No.	Description	Ø x H (mm)	Price
029117	Radioactive waste container with a 2 litre bottle	140 x 286	N/A -

## Spare bottles

Cat. No.	Description	Price
029330A	Spare bottle 2 litres	N/A -

## Beta radioactive waste box

9.5 mm thick acrylic box for the protection of beta radioactive isotopes.

- Removable lid
- L x W x H: 304 x 203 x 381 mm, holds bags measuring L x W x H: 305 x 152 x 380 mm
- Equipped with clips for fixing bags



Cat. No.	Description	Price
045900	Acrylic box	N/A -

## Anti-beta protection shield

Anti-beta protection screen with a wide base acting as a tray for samples. Straight and then tilted for a better view of the completed work. Thickness: 9.5 mm.

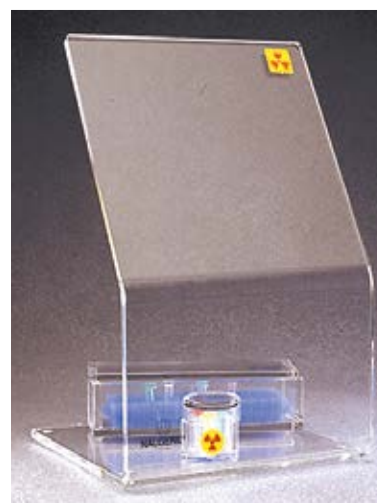

Cat. No.	Description	L x W x H (mm)	Price
028678	Acrylic anti-beta shield	305 x 305 x 457	N/A -
028679	Acrylic anti-beta shield	457 x 305 x 610	N/A -

## TFD foam, radioactivity decontaminant

Effective during all decontamination operations of radioisotopes usually used in nuclear medicine (Technetium Tc 99, Thallium Tl 201, Gallium Ga 67, Indium In 111, Iodine I 131), in research laboratories (Carbon C 14, Chromium Cr 51, Tritium T 3, Iodine I 125, Phosphorus P 32, Xenon Xe 131, Yttrium Y90)

Composition:

- surfactants: anionic and non-ionic;
- Sequestrants;
- propellant stabilisers: butane / propane mixture

- Detergent and degreaser: the foam removes all kinds of contaminated dirt and grease
- Decontamination of radioactivity: the sequestrants remove and carry away radioisotopes fixed on all types of support, forming easily removable water-soluble metal complexes
- Odourless white foam
- pH = 7
- Compatible with all types of materials
- To be used by spraying directly onto the surface to be decontaminated

Cat. No.	Description	Price
711171	Radioactive decontaminant TFD foam 500 ml	N/A -



See also our labels "radioactivity symbol" page 1244



## TFD Radioactive decontaminant skin cleaner

- Foaming cream soap
- Unscented
- Cleaner, softener, radioactivity decontaminant
- neutral pH
- Prevents the skin from drying out

Cat. No.	Description	Price
711547B	TFD skin radioactivity decontaminant 460 g	N/A -



See Disinfecting detergents radioactivity page 1282



## Sterilsop® Protec Transport and storage bags after sterilisation



Allows the transport and storage of sterile instrumentation. Allows for an increase in the shelf life of sterilised items, according to the point scale from the 1993 "Good Sterilisation Practices".

- Made of 60 micron polyethylene
- Self-adhesive tamper-evident closure (tight and airtight when closed)
- Pre-printed label for date and content identification
- Bottom gusset to prevent tearing when inserting items into the protective bag

Cat. No.	Dimensions (mm)	Units/box	Price / box
161554B	230 x 380 mm	200	N/A -
161555	320 x 500 mm	200	N/A -
161556	420 x 760 mm	200	N/A -

## Heat-sealable sheaths



- In HDPE
- Thickness 100 µm
- Very resistant
- Certified for food contact

Cat. No.	Roll width (mm)	Roll length (m)	Price the roll
999651	40	350	N/A -
999652	60	350	N/A -
999650	80	350	N/A -
999653	120	350	N/A -

## Dry heat sterilisation bags and sheaths



Sachets and sheaths for the sterilisation of objects, tools, using dry heat (Poupinel). Maximum temperature: 180 °C.

- Special polyamide for welding (260/270 °C)
- Sterilisation indicator
- Available in bags or in sheaths rolls

### Dry heat bags

Cat. No.	L x W (mm)	Units/box	Price/box
018001	200 x 50	100	N/A -
018002	200 x 80	100	N/A -
018003	250 x 120	100	N/A -
018005	300 x 200	100	N/A -
018004	500 x 300	100	N/A -

### Dry heat sheaths

Cat. No.	Width (mm)	Roll of	Price/roll
018006	50	50 m	N/A -
018007	80	50 m	N/A -
018008	120	50 m	N/A -
018009	200	50 m	N/A -
018010	300	50 m	N/A -

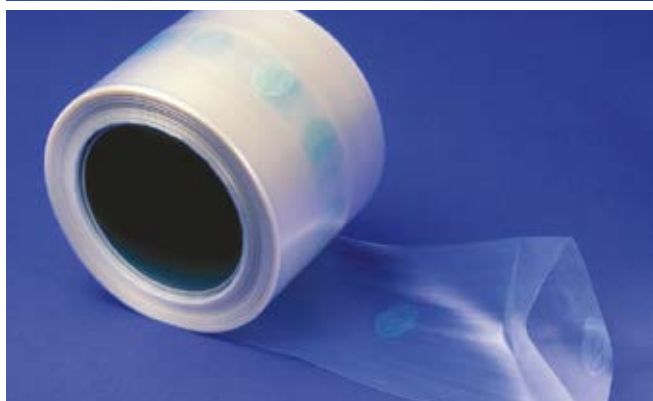



## Sterilsop SX bags and sheaths

Heat-sealable moist heat sterilisation packaging.

Responds to 3 main functions: permeability to the sterilising agent, maintenance of the sterility of the contents, aseptic extraction of the sterilised material.

- Complies with EN ISO 11607 and EN 868-5
- Class 1 medical device
- Permeable paper side with indicators
- Transparent pink complex side: polyester (12 µm)/polypropylene (40 µm)
- Indicators change from pink to brown after steam sterilization
- Sealing 175 °C - 185 °C (impulse sealer), 170 °C - 190 °C (scroll sealer)

### Peelable bags

Dim. L x W (mm)	Cat. No.	Price 100 units
75 x 150	067960B	N/A -
75 x 200	067952B	N/A -
75 x 250	067961B	N/A -
75 x 300	067962B	N/A -
100 x 150	067963B	N/A -
100 x 250	067964B	N/A -
100 x 300	067950B	N/A -
100 x 350	067966B	N/A -
120 x 300	067967B	N/A -
150 x 200	067968B	N/A -
160 x 220	067969B	N/A -
160 x 330	067953B	N/A -
150 x 350	067970B	N/A -
210 x 420	067971B	N/A -
210 x 280	067972B	N/A -
210 x 350	067951B	N/A -
220 x 420	067974B	N/A -
280 x 350	067954B	N/A -
270 x 430	067975B	N/A -
270 x 450	067976B	N/A -
320 x 520	067977B	N/A -
420 x 500	067955B	N/A -
420 x 600	067956B	N/A -

- 6 indicators/bag (spread over 3 sides)



### Flat peelable sheaths

Sheath Width (mm)	Cat. No.	Price the roll of 50 m
50	161536B	N/A -
75	161537B	N/A -
90	161538B	N/A -
100	161539B	N/A -
120	161540B	N/A -
210	161524D	N/A -
270	161527D	N/A -
320	161534B	N/A -
400	161535B	N/A -

- Indicators on both sides of the roll
- 50 m roll



## ULTRA® Sterilisation bags and sheaths

- 1 non-woven porous side "ULTRA" 90 g/m<sup>2</sup> and 1 transparent side for the visualization of the content
- High resistance to mechanical forces and perforation
- Peelable without tearing
- No defibrination, no particulate emissions
- Suitable for autoclave sterilisation
- Complies with NF EN ISO 11607-1 et EN 868-5

### Flat sheaths

Cat. No.	Dimensions (mm)	Dimensions (mm)	Units/box	Price/box
095125	120	70	2	N/A -
095126	160	70	2	N/A -
095129	320	70	1	N/A -
095130	380	70	1	N/A -
095131	420	70	1	N/A -
095132	470	70	1	N/A -
095133	520	70	1	N/A -
095134	580	70	1	N/A -



### Flat bags

Cat. No.	Dimensions (mm)	Units/box	Price/box
095117	120 x 400	1000	N/A -
005948	160 x 300	1200	N/A -
095120	285 x 450	500	N/A -
095121	320 x 500	500	N/A -
095122	280 x 450	500	N/A -

## Sterilisation bags and sheaths made of paper/clear plastic

- Compliant with EN ISO 11607 and DIN 868-5
- Paper 70 g/m<sup>2</sup> impermeable to micro-organisms but permeable to air
- Blue Film 12/40 PET/PP

- For steam and gas sterilisation
- 3 indicators printed outside the filling area: steam, ethylene oxide, formaldehyde

### Gusseted bags



Cat. No.	Dim. W x L x D (cm)	Units/box	Price/box
019622	10 x 30 x 5	2000	N/A -
019623	10 x 40 x 5	2000	N/A -
019624	15 x 28 x 5	1000	N/A -
019625	15 x 40 x 5	1000	N/A -
019626	20 x 40 x 5	1000	N/A -
019627	20 x 48 x 5	500	N/A -
019628	25 x 48 x 6.5	500	N/A -
019629	30 x 61 x 6.5	500	N/A -
019630	41 x 61 x 6.5	500	N/A -

### Flat bags



Cat. No.	Dim. W x L (cm)	Units/box	Price/box
019580	5.5 x 20	2000	N/A -
019581	5.5 x 25	2000	N/A -
019582	7.5 x 15	2000	N/A -
019583	7.5 x 20	2000	N/A -
019584	7.5 x 25	2000	N/A -
019585	7.5 x 30	2000	N/A -
019586	10 x 15	2000	N/A -
019587	10 x 20	2000	N/A -
019588	10 x 25	2000	N/A -
019589	10 x 30	2000	N/A -

### Flat or gusseted sheaths



#### Flat sheaths (200 m roll)

Cat. No.	Width (cm)	Units/box	Price/box
019631	5	6	N/A -
019632	7.5	4	N/A -
019633	10	3	N/A -
019634	12.5	2	N/A -
019635	15	2	N/A -
019636	20	2	N/A -
019637	25	2	N/A -
019638	30	1	N/A -
019639	38	1	N/A -
019640	42	1	N/A -

#### Gusseted sheaths (100 m roll)

Cat. No.	Dim. W x D (cm)	Units/box	Price/box
019641	7.5 x 2.5	4	N/A -
019642	10 x 5	3	N/A -
019643	15 x 5	2	N/A -
019644	20 x 5	2	N/A -
019645	25 x 6.5	2	N/A -
019646	30 x 6.5	1	N/A -
019647	38 x 8	1	N/A -

### Clear plastic non-woven bags and sheaths



- Compliant with EN ISO 11607 and DIN 868-5
- Made of 60 g/m<sup>2</sup> fleece and plastic film: flexible fleece with high air and vapour permeability for large volumes
- For steam and gas sterilisation
- 3 indicators printed outside the filling area: steam, ethylene oxide, formaldehyde

Cat. No.	Type	Dimensions W x L	Units/box	Price/box
019648	Flat bag	27 x 36 cm	500	N/A -
019649	Flat bag	32 x 45 cm	500	N/A -
019650	Flat bag	40 x 52 cm	250	N/A -
019651	Flat bag	50 x 60 cm	250	N/A -
019652	Flat bag	57 x 72 cm	250	N/A -
019653	Flat sheath	20 cm x 100 m	2	N/A -
019654	Flat sheath	42 cm x 100 m	1	N/A -

Cat. No.	Dim. W x L (cm)	Units/box	Price/box
019606	21 x 33	1000	N/A -
019607	22 x 30	1000	N/A -
019608	22 x 35	1000	N/A -
019609	22 x 42	1000	N/A -
019610	25 x 38	1000	N/A -
019611	25 x 40	1000	N/A -
019612	25 x 42	1000	N/A -
019613	25 x 48	500	N/A -
019614	27 x 45	500	N/A -
019615	30 x 42	500	N/A -
019616	30 x 57	500	N/A -
019617	32 x 50	500	N/A -
019618	36 x 58	500	N/A -
019619	38 x 50	500	N/A -
019620	42 x 50	500	N/A -
019621	42 x 61	500	N/A -
019590	10 x 36	1000	N/A -
019591	10 x 40	1000	N/A -
019592	10 x 52	1000	N/A -
019593	12.5 x 25	2000	N/A -
019594	12.5 x 30	2000	N/A -
019595	12.5 x 40	1000	N/A -
019596	12.5 x 52	1000	N/A -
019597	15 x 20	1000	N/A -
019598	15 x 27	1000	N/A -
019599	15 x 30	1000	N/A -
019600	15 x 38	1000	N/A -
019601	15 x 61	1000	N/A -
019602	16 x 22	1000	N/A -
019603	20 x 27	1000	N/A -
019604	20 x 40	1000	N/A -
019605	20 x 61	1000	N/A -

### Tyvek® bags and sheaths, transparent plastic



- Complies with EN ISO 11607 and DIN 868-9
- In Tyvek® 1073B of 75 g/m<sup>2</sup>
- For heat sensitive instruments
- Plasma sterilisation, ethylene oxide, irradiation
- 2 indicators printed outside the filling area: plasma, ethylene oxide
- Very limited ethylene oxide absorption, low residual gases
- Excellent barrier against micro-organisms and moisture
- Heat sealable between 115 and 135 °C

Cat. No.	Type	Dimensions W x L	Units/box	Price/box
019655	Flat bag	7.5 x 20 cm	1000	N/A -
019656	Flat bag	10 x 27 cm	500	N/A -
019657	Flat bag	15 x 30 cm	500	N/A -
019658	Flat bag	20 x 40 cm	500	N/A -
019659	Flat bag	25 x 48 cm	500	N/A -
019660	Flat sheath	7.5 cm x 100 m	2	N/A -
019661	Flat sheath	10 cm x 100 m	2	N/A -
019662	Flat sheath	15 cm x 100 m	1	N/A -
019663	Flat sheath	20 cm x 100 m	1	N/A -
019664	Flat sheath	25 cm x 100 m	1	N/A -
019665	Flat sheath	30 cm x 100 m	1	N/A -
019666	Flat sheath	38 cm x 100 m	1	N/A -
019667	Flat sheath	50 cm x 100 m	1	N/A -

## Bags and sheaths for sterilisation

### Flat bags (sealable)

Cat. No.	W x L (mm)	Pack unit.	Price
005906	80 x 250	100	N/A -
005909	120 x 200	100	N/A -
005915	160 x 200	100	N/A -
005919	160 x 500	100	N/A -
005922	220 x 300	100	N/A -
005924	220 x 450	100	N/A -
005929	250 x 400	100	N/A -
005934	285 x 450	100	N/A -
005939	320 x 550	100	N/A -
005945	420 x 650	100	N/A -

### Gusseted bags (sealable)

095012B	100 x 300 x 40	100	N/A -
095013B	160 x 360 x 45	100	N/A -
095014	200 x 400 x 50	100	N/A -
095015B	320 x 500 x 60	100	N/A -
095016B	420 x 600 x 90	100	N/A -

### Flat bags (self-adhesive closure)

095017	70 x 230	100	N/A -
095018	90 x 230	100	N/A -
095020	130 x 254	100	N/A -
095116	130 x 356	100	N/A -
095021	200 x 330	100	N/A -
095022	300 x 390	100	N/A -

### Flat sheaths (welded closure)

Cat. No.	Width (mm)	Price the 200 m roll
095023B	50	N/A -
095024B	80	N/A -
095025D	120	N/A -
095026B	160	N/A -
095027B	220	N/A -
095028B	285	N/A -
095029B	320	N/A -
095030B	420	N/A -

Flat sheaths and bags



For autoclave and ethylene oxide.

Bags and sheaths for packaging devices, compatible with steam and ethylene oxide gas sterilisation processes.

- 1 paper 60 g/m<sup>2</sup> side, 1 transparent PET/PP plastic side
- Steam and gas sterilisation indicator OE
- Welded or self-adhesive closure
- Flat (single) bags and sheaths or gusseted (increases bag capacity) bags and sleeves
- Sachets and sheaths are peelable when opened



Gusseted sheaths and bags

### Gusseted sheaths (welded closure)

Cat. No.	L x W (mm)	Roll length (m)	Price the roll
095109	75 x 30	100	N/A -
095110	100 x 40	100	N/A -
095111	150 x 50	100	N/A -
095112	200 x 50	100	N/A -
095113	250 x 60	100	N/A -
095114	300 x 60	100	N/A -
095115	380 x 80	100	N/A -
095037	420 x 90	66	N/A -

## Quattro Premium sterilisation bags and sheaths

- For steam sterilisation, ethylene oxide; with class 4 sterilisation indicators
- In paper (60 g/m<sup>2</sup>) and polypropylene and polyethylene film (50 µm)
- Puncture resistant, multi-layer thick polypropylene and polyethylene film
- Blue transparent film for easy viewing of contents and identification of tears or perforations
- Clean opening of the seal for aseptic extraction of the contents

### Self-adhesive flat sterilisation bags

Cat. No.	Dimensions (mm)	Price the box of 200
475315A	70 x 229	N/A -
475316A	89 x 133	N/A -
475317A	89 x 229	N/A -
475318A	57 x 102	N/A -
475319A	133 x 254	N/A -
475320A	191 x 330	N/A -
475321A	254 x 356	N/A -
475322A	305 x 432	N/A -

### Flat sterilisation sheaths

Cat. No.	Dimensions (mm)	Price the roll of 200
475328A	50	N/A -
475329A	75	N/A -
475330A	100	N/A -
475331A	150	N/A -





## Sterilisation foils

- According to ISO 11607, EN 868, CE
- For the packaging of parts to be sterilised, from the lightest to the most demanding

### Sterilisation foils made of crepe paper



- The standard paper for packaging kits and lightweight instruments
- 100% medical grade cellulose paper
- The "Crepe Sensitive" material is softer and more flexible to use

White	Green	Dim. L x W (cm)	Units/box	Price/box
<b>Standard Crepe paper</b>				
019504	019512	80 x 80	250	N/A -
019505	019513	90 x 90	250	N/A -
019506	019514	100 x 100	250	N/A -
019507	019515	120 x 120	125	N/A -
<b>"Sensitive" crepe paper</b>				
019517	019522	75 x 75	250	N/A -
019518	019523	90 x 90	250	N/A -
019519	019524	100 x 100	250	N/A -

### Alternately stacked sheets



- Damage to the packaging is more easily distinguishable through the alternately stacked sheets
- Use the green non-woven fabric in internal packaging

Cat. No.	Dim. L x W (cm)	Units/box	Price/box
<b>Blue/green non-woven 52 g/m<sup>2</sup></b>			
019544	75 x 75	200	N/A -
019545	90 x 90	200	N/A -
019546	100 x 100	200	N/A -
019547	120 x 120	100	N/A -
019548	120 x 140	100	N/A -
<b>SMMS 43 g/m<sup>2</sup> and green non-woven 57 g/m<sup>2</sup></b>			
019573	75 x 75	200	N/A -
019574	100 x 100	200	N/A -
019575	120 x 120	120	N/A -
019576	140 x 140	120	N/A -
<b>SMMS 60 g/m<sup>2</sup> and green non-woven 67 g/m<sup>2</sup></b>			
019577	100 x 100	160	N/A -
019578	120 x 120	120	N/A -
019579	140 x 140	80	N/A -

### Non-woven sterilisation sheets 52 g/m<sup>2</sup>

- For packaging instrument baskets and textiles

Blue	Green	Dim. L x W (cm)	Units/box	Price/box
019526	019537	50 x 50	500	N/A -
019527	019538	60 x 60	500	N/A -
019528	019539	75 x 75	200	N/A -
019529	019540	90 x 90	200	N/A -
019530	019541	100 x 100	200	N/A -
019531	-	100 x 140	100	N/A -
019532	019542	120 x 120	100	N/A -
019533	-	120 x 140	100	N/A -
-	019543	130 x 130	100	N/A -
019534	-	130 x 150	100	N/A -
019535	-	140 x 140	100	N/A -
019536	-	150 x 190	100	N/A -

### Non-woven sterilisation sheets 59 g/m<sup>2</sup>

- Recommended for internal packaging of heavy parts
- Made of cellulose blend with polyester fibres: good strength and drape

Blue	Dim. L x W (cm)	Units/box	Price/box
019549	60 x 60	500	N/A -
019550	75 x 75	200	N/A -
019551	90 x 90	200	N/A -
019552	100 x 100	200	N/A -
019553	120 x 120	100	N/A -
019554	140 x 140	100	N/A -

### Polypropylene non-woven sterilisation sheets SMMS 37 g/m<sup>2</sup> or 60 g/m<sup>2</sup>



- Polypropylene fibres in 4 layers: The 2 Spunbond layers provide exceptional flexibility and drapability, whereas the 2 meltblown layers provide excellent defence against bacteria.

- Offers good tear resistance

Blue	Dim. L x W (cm)	Units/box	Price/box
<b>37 g/m<sup>2</sup></b>			
019555	75 x 75	200	N/A -
019556	90 x 90	200	N/A -
019557	100 x 100	200	N/A -
019558	120 x 120	120	N/A -
019559	120 x 140	120	N/A -
019560	140 x 140	120	N/A -
019561	140 x 190	80	N/A -
<b>60 g/m<sup>2</sup></b>			
019570	100 x 100	104	N/A -
019571	120 x 120	96	N/A -
019572	140 x 140	80	N/A -

### Polypropylene non-woven sterilisation sheets SSMS 43 g/m<sup>2</sup>

- Non-woven polypropylene 43 g/m<sup>2</sup>

- For packaging heavier medical products

- Promotes the absorption of residual moisture after sterilisation

- Compliant with DIN EN 13795: surgical drapes for "less critical areas"

- 1 blue side, 1 purple side

Cat. No.	Dim. L x W (cm)	Units/box	Price/box
019562	50 x 50	500	N/A -
019563	75 x 75	200	N/A -
019564	90 x 90	200	N/A -
019565	100 x 100	200	N/A -
019566	120 x 120	120	N/A -
019567	120 x 140	120	N/A -
019568	140 x 140	120	N/A -
019569	150 x 190	48	N/A -

## Sterilising paper sheets



- Format 40 x 60 cm
- For dry heat sterilisation
- Supplied per 500 sheets

Cat. No.	Description	Price 500 units
006950	Sterilisation sheets	N/A -

## Greaseproof paper



Large sheet paper 65 cm x 1 metre.  
For sterilisation and packaging of large objects.

Cat. No.	Description	Price 500 units
094001	Greaseproof paper 65 x 100 cm	N/A -

## DEXTEX Sterilisation sheets

Non-woven sterilisation sheets. For packaging various products for ethylene oxide or steam sterilisation. Two models available:

- DEXTEX 1 (blue) 56 g/m<sup>2</sup>, 64 % cellulose, 10 % polyester fibres, 26% acrylic binder;
- DEXTEX 2 (green) 67 g/m<sup>2</sup>, 64 % cellulose, 15 % polyester fibres, 21 % acrylic binder

- Prevent migration of micro-organisms
- Hydrophobic packaging
- Non-woven, lint-free

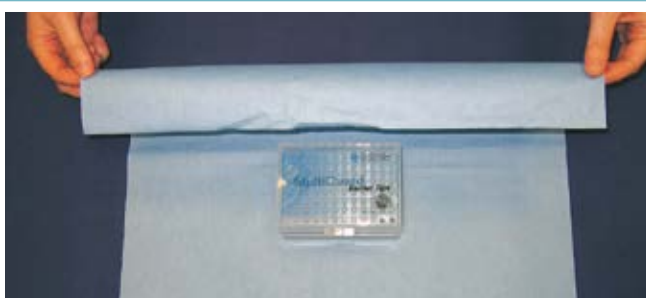

### DEXTEX 1 non-woven sterilisation sheets 56 g/m<sup>2</sup>

Cat. No.	L x W (mm)	Units/box	Price/box
095046	500 x 500 mm	500	N/A -
095047	600 x 600 mm	500	N/A -
095048B	750 x 750 mm	200	N/A -
095049B	900 x 900 mm	200	N/A -
095050	1000 x 1000 mm	200	N/A -
095051	1200 x 1200 mm	100	N/A -
095052	1370 x 1370 mm	100	N/A -

### DEXTEX 2 non-woven sterilisation sheets 67 g/m<sup>2</sup>

Cat. No.	L x W (mm)	Units/box	Price/box
095055	600 x 600 mm	500	N/A -
095056	750 x 750 mm	250	N/A -
095057	900 x 900 mm	250	N/A -
095058	1000 x 1000 mm	200	N/A -
095059	1200 x 1200 mm	100	N/A -

## SENSITIVE Sterilisation sheets

- Economical solution
- Made of crepe paper, 60 g/m<sup>2</sup>
- High water resistance
- Suitable for steam and ethylene oxide sterilisation
- Easy to handle
- Good mechanical strength in dry or wet condition



### Crepe sterilisation sheets, lilac

Cat. No.	L x W (mm)	Units/box	Price/box
095100	500 x 500 mm	500	N/A -
095071	600 x 600 mm	500	N/A -
095072	750 x 750 mm	250	N/A -
095073	900 x 900 mm	250	N/A -
095075	1000 x 1000 mm	200	N/A -
095076	1200 x 1200 mm	125	N/A -

### Crepe sterilisation sheets, green

Cat. No.	L x W (mm)	Units/box	Price/box
095081	500 x 500 mm	500	N/A -
095083	600 x 600 mm	500	N/A -
095041	750 x 750 mm	250	N/A -
095084	900 x 900 mm	250	N/A -
095086	1000 x 1000 mm	250	N/A -
095087	1200 x 1200 mm	125	N/A -

# INDICATORS FOR STERILISATION

## Autoclave indicator tape



- Self-adhesive
- Roll 19 mm x 50 m
- For steam sterilisation between 121 °C and 134 °C
- The tape changes colour when sterilisation is carried out

Cat. No.	Description	Price
490009	Autoclave indicator tape	N/A -

## Neutral autoclave adhesive tape

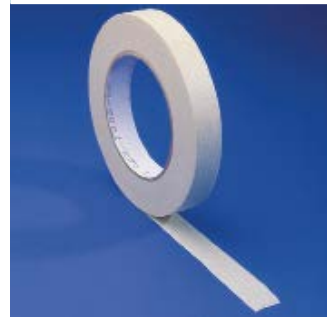

Adhesive tape for closing containers or packaging products for autoclaving. Does not have a sterilisation indicator.

Cat. No.	Description	Price
150262	18 mm x 50 m roll	N/A -
150272	24 mm x 50 m roll	N/A -
150263	48 mm x 50 m roll	N/A -
086000	Tape dispenser	N/A -

## Sterilisation indicator tapes

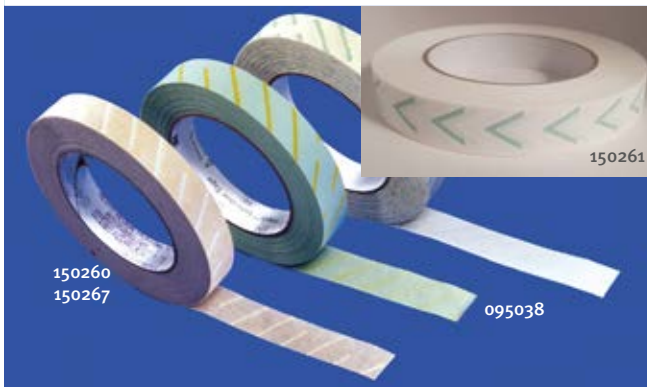

The adhesive indicator tapes to be placed on the products to be sterilised allow the passage to sterilisation to be certified. Coloured bands appear at the end of the sterilisation process. 3 models of indicator tapes are available: for autoclave (wet heat), for poupinel (dry heat) and for gas (ethylene oxide).

Dispensers 086000 and 140265 are suitable for use with the tape (see page 1235).

Cat. No.	Description	Dimensions	Units/box	Price/box
150260	Autoclave Indicator tape	50 m x 19 mm	1	N/A -
150261	Poupinel Indicator tape	55 m x 19 mm	1	N/A -
095038	Ethylene oxide Indicator tape	50 m x 19 mm	1	N/A -
150267	Autoclave Indicator tape 3M	55 m x 18 mm	1	N/A -
150283	Autoclave Indicator tape 3M	55 m x 24 mm	1	N/A -

## Steripoint® sterilisation indicator



- High accuracy in the shift time
- Constant reproducibility
- Quality commitment due to the numerous controls of shift times during production
- The shift of Steripoint® is inhibited by the presence of a steam / air or gas mixture, or when one of the parameters of the cycle is insufficient
- The shift from purple to green ink indicates compliance of time, temperature and steam conditions during sterilisation cycles

Cat. No.	Colours	Sterilisation point	Units/box	Price/box
950171	Blue	134 °C 3,5 min. - 121 °C 15 min.	250	N/A -
950172	Pink	134 °C 5,3 min. - 121 °C 15 min.	250	N/A -
950173	Orange	134 °C 7 min. - 121 °C 20 min.	250	N/A -
950174	Green	134 °C 18 min.	250	N/A -

## Sterilisation and washing indicators



- Non-sequential integrator
- Declination according to autoclave cycles:
  - TST SKC short cycle: 121 °C/15 min
  - TST 3702 standard cycle: 125 °C/20 min

Cat. No.	Description	Units/box	Price/box
972446	Sterilisation and washing indicator TST SKC short cycle	200	N/A -
972440	Sterilisation and washing indicator 3702 SKC short cycle	200	N/A -



## Bowie-Dick Browne autoclave pack



Ready-to-use Bowie-Dick test pack for steam sterilizers. Indicator to be used in specific tests as defined in EN 867-1 class B and 867-4 and ISO 11140 class 2. Instructions for use: place the test in the centre of the top shelf and perform a BD cycle. Open the packet and check the sheet: a successful test is blue, another colour indicates a failure.

- Colour shift: from yellow to blue
- CE marked medical device
- Single use
- L x W x H (mm): 125 x 125 x 30

Cat. No.	Description	Tests/ pack	Price/ pack
972455	Bowie-Dick Browne Pack for autoclave	20 tests	N/A -

## Bowie & Dick Test "Mini-Control Pack"

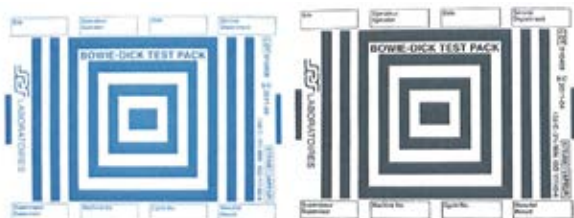

Steam penetration test "Mini-Control Pack".

- Lead-free ink
- Turning from blue to black
- Stable shift over several years
- Standards: EN ISO 11140-1 (class 2) and EN ISO 11140-4
- Can be used in large or small type b sterilizers (EN 13060)
- Sheets of blotting paper reproducing the constraints of the original Bowie & Dick test
- Minimum exposure conditions: 134 °C, saturated steam for 3 minutes 30 sec. or 121 °C saturated steam for 15 minutes

Cat. No.	Description	Tests/ pack	Price/ pack
095040	Test Mini-control Pack	30 tests	N/A -

## Bowie & Dick VISA test



To approach the daily vapour penetration test. The test sheet is placed in a "sandwich" within 2 laminated layers, reproducing the strain of steam penetration in accordance with EN 867-4. The removal of the paper packaging improves the constraints linked to waste disposal.

- Lead-free ink
- Colour shift from pink to green
- Compact: facilitates storage conditions
- Reproducibility and stability of the shift after sterilisation (stable over several years)
- Blotting paper test sheet placed between two laminate layers: removal of wrapping paper pack
- Minimum exposure conditions: 134 °C in saturated steam for 3 minutes 30 seconds, 121 °C in saturated steam for 15 minutes.
- Standards: EN ISO 11140-1 (class 2) and EN ISO 11140-4

Cat. No.	Description	Tests/ pack	Price/ pack
095096	Bowie & Dick Test VISA	120 tests	N/A -

## Prion Emulator 134-18 NS

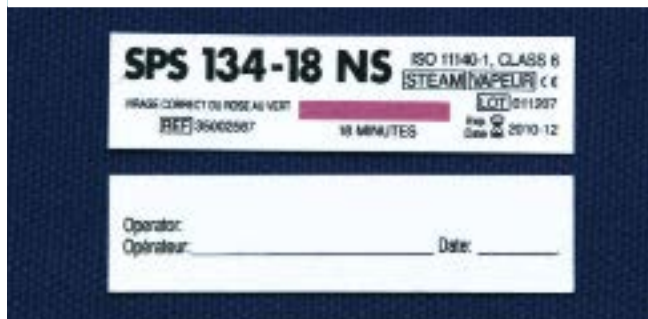

The Prion 134-18 NS emulator is a multi-parameter class 6 indicator (temperature, time and saturated steam). It is used for steam sterilisation, Prion cycle 134 °C / 18 minutes.

- Class 6 non-sequential emulator
- Multi-parameters (time/temperature/steam contact)
- Designed to improve the threshold of detection of possible malfunctions
- Physiochemical ink
- 2 laminated sides to avoid any risk of migration
- Compliance with EN ISO 11140-1

Cat. No.	Description	Units/ box	Price/ box
095089	Prion Emulator 134-18 NS	250	N/A -

## Gamma ray sterilisation indicators

- 12.5 mm diameter adhesive labels
- Store in the fridge between 5 and 10 °C
- Exposition > 10 kGy: colour shift from yellow to red
- 24 month life span

Cat. No.	Description	Labels/ roll	Price/ roll
071500	Round gamma sterilisation indicator labels	5000	N/A -

## Brushes for cleaning glass tubes



Cat. No.	Length (mm)	L x ø head (mm)	Price
020391	290	100 x 30	N/A -
020392	360	120 x 50	N/A -

## Brushes for burettes and tubes



➤ Brush for burettes: nylon garnishing

➤ Brushes for tubes: straight plastic end

Cat. No.	Diameter (mm)	Lining	Tip	Brush length (mm)	Total length (mm)	Price
069142A	4	Nylon 9/100°	Rough end	50	450	N/A -
069143A	4	Nylon 10/100°	Twisted with loop	60	480	N/A -
069146A	4	Nylon 10/100°	Rough end	40	250	N/A -
069141A	6	Nylon 10/100°	Rough end	50	450	N/A -
069140A	10	Silk	Twisted with loop	110	480	N/A -
069137A	12	Silk	Twisted with loop	80	270	N/A -
069138A	12	Silk	Tufted end	80	270	N/A -
069144A	15	Silk	Tufted end	80	270	N/A -
069130A	18	Silk	Twisted with loop	110	360	N/A -
069131A	18	Silk	Tufted end	110	360	N/A -
069132A	25	Silk	Twisted with loop	110	360	N/A -
069133A	25	Silk	Tufted end	110	360	N/A -
069127A	25	Nylon 20/100°	Tufted end	110	610	N/A -
069134A	30	Silk	Twisted with loop	110	360	N/A -
069136A	30	Nylon 30/100°	Twisted with loop	110	360	N/A -
069135A	30	Silk	Tufted end	110	360	N/A -
069129A	50	Silk	Tufted end	120	620	N/A -
069128A	50	Silk	Twisted with loop	90	440	N/A -



## ProCare Lab cleaning product range

For various applications and soil removal in washer-disinfectors.

Product	ProCare Lab 11 MA	ProCare Lab 11 AP	ProCare Lab 10 MA	ProCare Lab 10 AP	ProCare Lab 10 AT	ProCare Lab 10 AO	ProCare Lab 30 C	ProCare Lab 30 P
pH value	Detergent, mildly alkaline	Alkaline detergent	Alkaline detergent	Alkaline detergent	Alkaline detergent	Alkaline detergent	Acid neutralizing agent based on citric acid	Acid neutralizing agent based on phosphoric acid
PH range	11.7 - 11.9	11.5 - 11.7	11.6 - 11.8	12.5 - 12.7	12.2 - 12.5	11.8 - 12.1	2.9 - 2.5	-
Physical state	Powder	Powder	Liquid	Liquid	Liquid	Liquid Powder	Liquid	Liquid Powder
Properties	Anti-foam action, without oxidising agents	Oxidising effect, phosphate-free	Free of surfactants and oxidising agents	Free of surfactants, phosphates, and oxidising agents	Surfactants, without phosphates, silicates or oxidising agents	Oxidising agents, without surfactants	Free of surfactants and phosphates	Surfactant-free
Components	Phosphates, silicates, surfactants	Oxygen bleach, surfactants	Alkali hydroxide, phosphates, silicates	Alkaline hydroxide, polycarboxylates	Alkaline hydroxide, polycarboxylates, surfactants	Chlorine-based bleach, phosphates	Citric acid	Phosphoric acid
Types of soiling	Blood, proteins, food residues	Organic impurities and inorganic	Blood, protein, soil residues	Stubborn and dry residues	Stubborn residues such as oils, greases, paraffins, resins, organic dyes	Blood, proteins, soil residues, inorganic residues, cell culture residues and tissue, radioactive components, algae	Acid soluble residues	Limestone and other acid soluble impurities
Compatible materials	Stainless steel, laboratory glassware, ceramics, and plastics (PE, PP, PVDF, PTFE)	Stainless steel, laboratory glassware, ceramics, and plastics (PE, PP, PVDF, PTFE)	Stainless steel, laboratory glassware, ceramics, and plastics (PE, PP, PVDF, PTFE)	Stainless steel, laboratory glassware, ceramics, and plastics (PE, PP, PVDF, PTFE)	Stainless steel, laboratory glassware, ceramics, and plastics (PE, PP, PVDF, PTFE)	Stainless steel, laboratory glassware, ceramics, and plastics (PE, PP, PVDF, PTFE)	Stainless steel, laboratory glassware, ceramics, and plastics (PE, PP, PVDF, PTFE), neutralisation of non-anodised aluminium	Stainless steel, laboratory glassware, ceramics, and plastics (PE, PP, PVDF, PTFE)
Non-compatible materials	Anodised aluminium	Light metals, non-ferrous metals, aluminium, anodised aluminium	Anodised aluminium	Light metals, non-ferrous metals, aluminium, anodised aluminium	Light metals, non-ferrous metals, aluminium, anodised aluminium	Light metals, non-ferrous metals, anodised aluminium, aluminium	Light metals, non-ferrous metals, chrome and nickel surfaces, anodised aluminium, acid pre-wash of non-anodised aluminium	Light metals, non-ferrous metals, chrome and nickel surfaces, anodised aluminium, aluminium
Packaging	10 kg	10 kg	5 l 10 l	5 l 10 l	5 l 10 l	5 l 12 kg	5 l 10 l	5 l 12 kg
Cat. No.	933452	933453	933444 933445	933446 933447	933448 933449	933450 933451	933454 933455	933456 933457
Price	N/A -	N/A -	N/A - N/A -	N/A - N/A -	N/A - N/A -	N/A - N/A -	N/A - N/A -	N/A - N/A -

Product	ProCare Lab Universal 61
Physical state	Regenerating salt, coarse-grained
Applications	Limescale deposition and load protection
Packaging	6 kg
Cat. No.	933458
Price	N/A -

### Accessory

Cat. No.	Description	Price
933459	Canister key, facilitates the opening of sealed canisters for safety reasons	N/A -



## Neodisher® Detergents and disinfectants



### Alkaline detergent powder

- **Neodisher® A8:** intensive alkaline detergent with high cleaning power for laboratory glassware
- **Neodisher® F:** intensive detergent with high cleaning power, good complexing and dispersing efficiency, phosphate-free, surfactant-free
- **Neodisher® GK:** low-alkaline detergent with disinfectant action, especially for glass objects with cell and tissue cultures, free of surfactants
- **Neodisher® LA:** intensive detergent with high emulsifying, dispersing and non-foaming efficiency, particularly suitable for the removal of greases, oils and paraffins

### Liquid alkaline detergents

- **Neodisher® FA:** a good emulsifying and dispersing detergent with high material protection, free of surfactants and oxidising agents
- **Neodisher® FT:** Surfactant-free detergent especially for microbiology

### Acid neutralizers and detergents

- **Neodisher® N:** phosphoric acid-based neutralizer and acid detergent, neutralizes by adding to the first rinse after using an alkaline detergent, without surfactants
- **Neodisher® Z:** Neutralizer and acid detergent based on organic acids, free of surfactants, phosphates and nitrogen-containing complexing agents. Particularly suitable as a neutraliser when added to the first rinse after using a low alkaline detergent

### Additive products

- **Neodisher® S Defoamer:** based on emulsified silicone oil A small dose is sufficient to prevent foam, even at low temperatures

### Disinfectant for food surfaces

- **Neoform K Plus:** terminal disinfection after the rinsing phase or cleaning and disinfection in one operation.

	Neodisher N		Neodisher Z			Neodisher A8		Neodisher F		Neodisher GK		Neodisher LA		Neodisher FA		Neodisher FT		Neodisher S Defoamer		Neoform K Plus	
<b>Use</b>																					
- In autoclave	•	•	•	•	•	•	•	•	•	•	•	•	•	•	•	•	•	•	•	•	•
- In manual																				•	•
<b>Function</b>																					
- Washing				•	•	•	•	•	•	•	•	•	•	•	•	•	•	•	•	•	•
- Neutralization	•	•	•																		
<b>Agents</b>																					
- A.C.S.	-	-	-	-	-	-	Chlorine	Chlorine	-	Chlorine	-	-	-	-	Chlorine	Silicone	-	-	-	-	-
- Caustic alkalis							•	•	•	•	•	•	•	•	•	•	•	•	•	•	•
- Alkali salts							•	•	•	•	•	•	•	•	•	•	•	•	•	•	•
- Complexing agents							•	•	•	•	•	•	•	•	•	•	•	•	•	•	•
- Combinations phosphoric	•	•	•				•	•	•	•	•	•	•	•	•	•	•	•	•	•	•
- Acid	•	•	•	•	•	•															
- Surfactants, emuls. agents												•							•		
<b>pH range</b>	Acid	Acid	Acid	Acid	Acid	Acid	Alkaline	Alkaline	Alkaline	Alkaline	Alkaline	Alkaline	Alkaline	Alkaline	Alkaline	Alkaline	Alkaline	Neutral	-	-	-
<b>Physical state</b>	Liquid	Liquid	Liquid	Liquid	Liquid	Liquid	Powder	Powder	Powder	Powder	Powder	Powder	Liquid	Liquid	Liquid	Liquid	Liquid	Liquid	Liquid	Liquid	Liquid
<b>Conditionnement</b>	Flacon	Bidon	Bidon	Bidon	Bidon	Bidon	Bucket	Flacon	Bucket	Bucket	Bucket	Bucket	Bidon	Bidon	Bidon	Flacon	Bidon	Bidon	Bidon	Bidon	Bidon
<b>Weight</b>	1 l	5 l	12 kg	5 l	10 l	20 l	10 kg	1 kg	3 kg	10 kg	3 kg	5 l	10 l	12 kg	1 l	5 l	10 l	1 l	5 l	10 l	10 l
<b>Cat. No.</b>	148606	148600	148601	148602	148603	148615	148616	148607	148619	148620	148621	148622	148623	148625	148627	148629	B148630	B148630	B148630	B148630	B148630
<b>Price</b>	N/A -	N/A -	N/A -	N/A -	N/A -	N/A -	N/A -	N/A -	N/A -	N/A -	N/A -	N/A -	N/A -	N/A -	N/A -	N/A -	N/A -	N/A -	N/A -	N/A -	N/A -



## RBS detergents and cleaners

Range of cleaning products for various uses.

- Available in different pH ranges
- Liquid detergents for manual, ultrasonic or soaking cleaning
- T 141: Alkaline multipurpose detergent cleaner
- T 105: alkaline detergent
- T 115: alkaline detergent phosphate-free
- T 120: alkaline detergent, phosphate-free, chloride-free
- T 230: neutral detergent
- T 305: acidic detergent based on phosphoric acid
- T 310: acidic detergent, phosphoric-acid-free
- T 342: deoxidising cleaner based on nitric acid
- Liquid detergents for automatic washing machines
- 50: Alkaline detergent
- A 260: Neutral detergent
- B 136: Acid detergent phosphoric acid based
- Available with or without phosphate
- Powder detergents for automatic washing machines
- SOLID: alkaline detergent
- SOLID pF: alkaline detergent, phosphate-free
- Acid neutralizers for automatic washing machines
- A 375: Phosphate-free acid neutralizer
- NA 2: Acid neutralizer based on phosphoric acid
- To be used in conjunction with alkaline detergents
- Radioactive cleaning and decontamination agent
- IND 470: cleans and decontaminates, halogen-free



711666



711669



711670



711687

	T 105	T 115	T 120	T 230	T 305	T 310	T 141	T 342	50	A 260	B 136	SOLID	A 375	NA 2	IND 470
--	-------	-------	-------	-------	-------	-------	-------	-------	----	-------	-------	-------	-------	------	---------

### Use

Automatic machine									•	•	•	•	•	•	
Manual or by dipping	•	•	•	•	•	•	•	•							•
For ultrasonic baths	•	•	•	•	•	•	•	•							

### Applications

Glassware	•	•	•				•	•	•			•	•	•	
Stainless steel, plastic, porcelain	•	•	•				•		•				•	•	
Sensitive materials (Al, Zn, and alloys)				•			•	•		•					
Descaler, deoxidiser Ideal for animal cages					•	•		•			•				
Acid neutralizer													•	•	
Radioactive decontamination															•

### Physical state

Liquid	•	•	•	•	•	•	•	•	•	•	•	•	•	•	•
Powder												•			
pH	Alkaline	Alkaline	Alkaline	Neutral	Acid	Acid	Alkaline	Acid	Alkaline	Neutral	Acid	Alkaline	Acid	Acid	Alkaline

### Composition

Phosphate-free		•	•				•						•		
Chloride free			•												
Phosphoric acid based					•						•			•	
Packaging	4 x 5 l	4 x 5 l	4 x 5 l	4 x 5 l	4 x 5 l	4 x 5 l	4 x 5 l	4 x 5 l	4 x 5 l	4 x 5 l	4 x 5 l	2 x 4.5 kg	4 x 5 l	4 x 5 l	4 x 5 l
Cat. No.	711668	711666	711669	711670	711671	711672	711688	711689	711673	711686	711676	711687	711679	711680	711681
Price	N/A -	N/A -	N/A -	N/A -	N/A -	N/A -	N/A -	N/A -	N/A -	N/A -	N/A -	N/A -	N/A -	N/A -	N/A -
Packaging	5 l	-	5 l	5 l	5 l	5 l	5 l	5 l	5 l	5 l	5 l	4.5 kg	5 l	5 l	5 l
Cat. No.	711668A	-	711669A	711670A	711671A	711672A	711688A	711689A	711673A	711686A	711676A	711687A	711679A	711680A	711681A
Price	N/A -	-	N/A -	N/A -	N/A -	N/A -	N/A -	N/A -	N/A -	N/A -	N/A -	N/A -	N/A -	N/A -	N/A -

## Franklab disinfectant detergents



	TFD 4	TFD 4 PF	TFD Neutral	DDN 9	TFD 7	TFD 7 PF	TFD 14	TFD 14 PF	Neutrax PF	Phosphax	NA 6	TFD Powder
<b>Type</b>	Foaming degreasing detergent			Neutral disinfectant detergent for the pre-disinfection of DM	Alkaline degreasing detergent				Acidic rinse agent for scrubbers	Acid neutralizer for scrubbers and renovation of surgical instruments	Detergent for cleaning animal cages	Alkaline powder detergent
<b>Use</b>												
Washer-disinfectors					x	x	x	x	x	x	x	x
Manual or soaking	x	x	x	x						x	x	x
Ultrasonic baths	x	x	x	x						x		
<b>Properties</b>												
Disinfectant				x								
Radioactive decontaminant	x	x	x	x	x	x	x	x				x
<b>Applications</b>												
Glassware	x	x	x	x	x	x	x	x	x			x
Stainless steel, plastic, porcelain	x	x	x	x	x	x	x	x	x			x
Sensitive materials			x	x	x	x			x	x	x	
Cages for animals										x	x	
Neutralizer									x	x		
<b>Type</b>	Liquid	Liquid	Liquid	Liquid	Liquid	Liquid	Liquid	Liquid	Liquid	Liquid	Liquid	Powder
pH	Alkaline	Alkaline	Neutral	Neutral	Alkaline	Alkaline	Alkaline	Acid	Acid	Acid	Acid	Alkaline
<b>Composition</b>												
Phosphate-free		x				x		x	x			x
Chloride free	x	x	x		x	x	x	x	x	x		x
Phosphoric acid based										x	x	
<b>Cat. No.</b>	<b>711590</b>	<b>711552</b>	<b>711526B</b>	<b>711591</b>	<b>711592</b>	<b>711593</b>	<b>711542B</b>	<b>711557</b>	<b>711540B</b>	<b>711594</b>	<b>711565</b>	<b>711173</b>
Packaging	4 x 5 l	4 x 5 l	4 x 5 l	4 x 5 l	4 x 5 l	4 x 5 l	4 x 5 l	4 x 5 l	4 x 5 l	4 x 5 l	4 x 5 l	4 x 5 kg
<b>Price</b>	<b>N/A -</b>	<b>N/A -</b>	<b>N/A -</b>	<b>N/A -</b>	<b>N/A -</b>	<b>N/A -</b>	<b>N/A -</b>	<b>N/A -</b>	<b>N/A -</b>	<b>N/A -</b>	<b>N/A -</b>	<b>N/A -</b>
<b>Cat. No.</b>	<b>711169B</b>	<b>711552A</b>	<b>711526A</b>	<b>711514B</b>	<b>711170B</b>	<b>711549</b>	<b>711542A</b>	<b>711557A</b>	<b>711540A</b>	<b>711528B</b>	<b>711565A</b>	<b>711173A</b>
Packaging	1 x 5 l	1 x 5 l	1 x 5 l	1 x 5 l	1 x 5 l	1 x 5 l	1 x 5 l	1 x 5 l	1 x 5 l	1 x 5 l	1 x 5 l	1 x 5 kg
<b>Price</b>	<b>N/A -</b>	<b>N/A -</b>	<b>N/A -</b>	<b>N/A -</b>	<b>N/A -</b>	<b>N/A -</b>	<b>N/A -</b>	<b>N/A -</b>	<b>N/A -</b>	<b>N/A -</b>	<b>N/A -</b>	<b>N/A -</b>
<b>Cat. No.</b>					<b>711253</b>	<b>711555</b>	<b>711527</b>	<b>711558</b>	<b>711172</b>	<b>711563</b>	<b>711595</b>	-
Packaging					2 x 10 l	2 x 10 l	2 x 10 l	2 x 10 l	2 x 10 l	2 x 10 l	2 x 10 l	-
<b>Price</b>					<b>N/A -</b>	<b>N/A -</b>	<b>N/A -</b>	<b>N/A -</b>	<b>N/A -</b>	<b>N/A -</b>	<b>N/A -</b>	-
<b>Cat. No.</b>					<b>711253A</b>	<b>711555A</b>	<b>711527A</b>	<b>711558A</b>	<b>711172A</b>	<b>711563A</b>	<b>711174</b>	-
Packaging					1 x 10 l	1 x 10 l	1 x 10 l	1 x 10 l	1 x 10 l	1 x 10 l	1 x 10 l	-
<b>Price</b>					<b>N/A -</b>	<b>N/A -</b>	<b>N/A -</b>	<b>N/A -</b>	<b>N/A -</b>	<b>N/A -</b>	<b>N/A -</b>	-

## Anios RN Neutralizer



Machine rinser and neutralizer. Neutralization of alkaline residues from detergents and water during the automatic machine washing cycle of medical-surgical devices and instruments.

- Suitable for short tank washing cycles
- Complexing effect of minerals
- Traceable by conductivity (1.77 mS/cm)
- Formulated with phosphoric acid (pH 2.5)
- Directions for use: dilute between 0.1 and 0.5% (1 to 5 ml/l); rinse with water at the end of the cycle

Cat. No.	Description	Price
059941A	ANIOS RN - 5 l canister	N/A -
059942	ANIOS RN - 10 l canister	N/A -

## Anios DLH Detergent



Instrumentation detergent. Cleaning of devices and equipment.

- Alkaline products
- Use with Anios RN
- Can be used in any water quality
- Non-corrosive
- pH 13.1
- Stability up to 95 °C
- Instructions for use: dilution between 0.3 and 0.5%; optimum temperature between 55 °C and 70 °C

Cat. No.	Description	Price
059948A	ANIOS DLH - 5 l canister	N/A -

## Specific detergent for glassware Lancer LLL



- Machine washable up to 95 °C
- Applicable to all types of glassware: laboratory, foodstuffs, baby bottles
- Sodium hydroxide based, environmentally friendly in normal use
- In 10 litre cans
- **NEW FORMULA:**
- Phosphate-free
- Non-toxic

Cat. No.	Description	Price
331700B	Liquid detergent LLL 10 litres	N/A -

## Lancer NLL liquid neutralizer



- Specific rinsing solution for glassware, allows to obtain a neutral pH after washing
- Applicable to all types of glassware: laboratory, foodstuffs, baby bottles
- Acetic acid based, environmentally friendly in normal use
- In 10 litre cans

Cat. No.	Description	Price
331701	Liquid neutralizer NLL 10 litres	N/A -

## Broxal® classic regenerating salt



- Compacted salt for water softening in dishwashers
- Suitable for all types of dishwashers

Cat. No.	Description	Price
155006	Broxal regenerating salt for dishes 2 kg	N/A -

## Regenerating salt for automatic washing machines



Softens the washing water, for a residue-less cleaning.

- Sodium chloride
- Odourless white granule

Cat. No.	Description	Price
711667	Regenerating salt, 5 l bucket	N/A -

## Lancer Regenerating Salt



Very high purity white salt, without insolubles that could block the softener. The packaging per kilo corresponds exactly to the quantity needed to fill the salt jar (thus avoiding random dosing). The packaging per unit allows the granulometry to be preserved in order to facilitate its dissolution during a cycle (without risk of agglomeration).

- Allows easier handling (built-in handle, easier to store) and reduction of packaging (ISO 14001 standard)

Cat. No.	Description	Price
331705B	Regenerating salt - 2 kg	N/A -

## NEOSEL Regenerating Salt



Recrystallising sodium chloride obtained by evaporation under vacuum and mechanically compressed. Specially developed to obtain a very high purity brine.

Cat. No.	Description	Price
148608	NEOSEL Regenerating Salt - 5 kg bucket	N/A -



## Tickopur and Stammopur cleaning solutions

- Increase cavitation
- Cleans intensively without chlorine compounds
- Can be used cold or hot



Range	Tickopur						Stammopur
	TR 3	R 27	R 30	R 33	RW 77	J 80 U	24
Description	TR 3	R 27	R 30	R 33	RW 77	J 80 U	24
Detergent	Special	Special	Neutral	Universal	Ammoniacal	Anti-oxidant / Anti-corrosion	Disinfectant, cleaner
Type	Concentrate	Concentrate	Concentrate	Concentrate	Concentrate	Ready to use	Concentrate
Properties	Weak acid, pH 3 to 1%	Acid, pH 1.9 to 1%	Neutral, pH 7	Alkaline, pH 9.9 to 1%	Alkaline, pH 9.9 to 1%	Acid, pH 2	Alkaline, pH 9.4 to 1%
Dosage	1 to 5 %	1 to 5 %	1 to 5 %	1 to 5 %	5 to 10 %		1 to 2 %
Notes	Nitric acid based, phosphate free	Bactericidal, algicidal, fungicidal	-	-	-	Use in glass/plastic beakers	-
Recommended for the following materials	Steel, stainless steel Non-ferrous metals Precious or light metals Glass Plastics	Steel, metals Glass Ceramic Plastics	Steel Non-ferrous metals Aluminium Glass Rubber Optical compounds, strainer	Metals Glass Ceramic Plastics Rubber	Steel, stainless steel Non-ferrous metals Glass Optical compounds, strainer Plastics	Non-ferrous metals Aluminium Copper Electronic microscope optics Plastics	Highly compatible
Remove	Mineral residues Corrosion Grease Oil Waxes Pigments Grinding and polishing residues	Rust Tartar Mineral residues Silicates Phosphates Cement Urine traces	Grease Oil Dust Proteins Waxes Silicone films	Grease Oil Ink residues Proteins Waxes Silicone films	Grease Oil Waxes Silicone films Lubricants Grinding and polishing residues	Oxide layers Sulphite layers	Bacteria Tuberculosis Yeast Viruses (BVDV, HBV, HCV, HIV) Anti-corrosion
Cat. No. - 1 litre	780143	780146	780149	780152	780155	780158	-
Price	N/A -	N/A -	N/A -	N/A -	N/A -	N/A -	-
Cat. No. - 2 litres	780144	780147	780150	780153	780156	780159	780161
Price	N/A -	N/A -	N/A -	N/A -	N/A -	N/A -	N/A -
Cat. No. - 5 litres	780145	780148	780151	780154	780157	780160	780162
Price	N/A -	N/A -	N/A -	N/A -	N/A -	N/A -	N/A -
Cat. No. - 25 litres	-	-	-	-	-	-	780163
Price	-	-	-	-	-	-	N/A -

### Detergent 7X

- Suitable for the maintenance of cell culture material
- Non-toxic
- Safe to use for the most delicate cleaning tasks
- Suitable for use in machines and ultrasonic baths



Cat. No.	Description	Can of	Units/box	Price/box
150115	Detergent 7X	3.8 litres	4	N/A -
150117	Detergent 7X O-Matic	4 litres	4	N/A -

### Detergent L-900 for plastics

Liquid detergent for cleaning plastics with a neutral pH. Use at a concentration of 5%.



Cat. No.	Description	Price
029301	Liquid detergent L-900 (4 litre can)	N/A -

## Aquet detergent



- Phosphate-free
- PH neutral
- For glass or plastic surfaces
- Non-ionic
- Biodegradable
- Use diluted to 1%

Cat. No.	Description	Price
088831	Aquet Detergent 20 bags x 20 ml	N/A -
085935	Aquet detergent 4 litres	N/A -

## Saniris concentrated degreasing cleaner



- Foaming concentrate for all surfaces
- Degreases and destroys bad odours in a lasting way
- Free of phenol derivatives, dyes, heavy metals and phosphates
- Formulas with essential oils or neutral fragrance

Perfume	1 l bottle	5 l canister
Garrigue (thyme, rosemary, mint, eucalyptus)	005641A	005642A
Lavender (lavender, bergamot, lemon)	005644A	005645A
<b>Price</b>	N/A -	N/A -
Neutral fragrance	005647A	005648A
<b>Price</b>	N/A -	N/A -

## Radioactive foaming degreasing/decontaminating detergent TFD<sub>4</sub>



- Odourless translucent liquid
- Alkaline solution (3% pH = 11.8; 10% pH = 12.5; pure pH = 13.5; specific gravity = 1.08)
- Composition: anionic and non-ionic surfactants, sequestering agents, stabilising agents
- Properties: detergent, bactericidal degreaser, radioactivity decontaminant, foaming, also for ultrasonic baths
- **Instructions for use:**
  - Immediate action: pour TFD<sub>4</sub> on the surface to be cleaned. Leave for a few moments and rub in. Rinse.
  - Fast acting: dilute TFD<sub>4</sub> (3 to 5%) in hot water at about 50 °C.
  - Soak the material for one hour. Brush if necessary. Rinse thoroughly with water.
  - Normal action: prepare a 0.5 to 3% solution of TFD<sub>4</sub> with warm water.
  - Immerse the material for 4 to 12 hours. Rinse thoroughly.

Cat. No.	Description	Price
71169B	Detergent / radioactive decontaminant TFD <sub>4</sub> 5 litres	N/A -

## LIPSOL detergent



- **Instructions for use**
  - 2-5% diluted solution
  - Soak the instruments between 2 and 24 hours
  - Rinse well with water with a final rinse with distilled water
  - Not recommended for washing machines

**TIP**



See other radioactive decontaminants on page 1267

Concentrated cleaning agent for laboratory and industrial applications.

- Non-corrosive, non-irritant
- Phosphate and enzyme free, fully biodegradable
- Effective as a radioactive decontamination agent
- Fully removed by rinsing
- Delivered in a sturdy UN-compliant cardboard box
- Tamper-proof cap
- Classification according to the latest CHIP standards (chemical regulations an categories chemical chemical for handling and transport)

Cat. No.	Description	Price
090844	LIPSOL detergent - 5 litre canister	N/A -

## Aniosyme X3 - pre-disinfectant detergent for instrumentation



- Enhanced cleaning and pre-disinfection of instrumentation
- Ultra high performance detergent, cleaning and degreasing power
- Clear blue liquid
- Optimised anti-microbial effectiveness in as little as 5 minutes
- Cleaning in an ultrasonic tank
- Collection of soiled instrumentation
- Tri-enzyme complex combined with a new generation non-ionic surfactant
- neutral pH: compatible with aluminium alloys (pH of the pure product: about 8)
- Formulated without chloride: anti-corrosive effect on materials
- **Instructions for use**
  - Dilute to 0.5%, i.e. pour a dose of 25 ml for 5 litres of cold or lukewarm water
  - Immerse the device completely (recommended soaking time: 5 min)
  - Brush if necessary
  - Rinse thoroughly with mains water (of good microbiological quality)
  - Wipe with a clean cloth

	25 x 25 ml doses	200 x 25 ml doses	1 litre dispensing bottle	12 x 1 litre dispensing bottles	5 litre canister	4 x 5 litre canister
Cat. No.	059918A	059918	059919A	059919	059920A	059920
Price	N/A -	N/A -	N/A -	N/A -	N/A -	N/A -

## Anios'Clean Excel D - pre-disinfectant instrument cleaner

- **Non-corrosive, compatible with a wide range of materials**
- **Broad antimicrobial spectrum**
- **pure pH: 7: effective formulation in soft and hard water**
- **Can be used as an ultrasonic tank**
- **Lemon scent**

### ➤ Instructions for use

- To be diluted to 0.5%: a dose of 25 ml in 5 litres of cold or lukewarm tap water
- Recommended soaking time: 15 min.
- Rinse thoroughly with tap water
- Wipe with a clean cloth



	200 x 25 ml doses	12 x 1 litre bottles	1 litre bottle	4 x 5 litre cans with pump
Cat. No.	059851	059852	059852A	059853
Price	N/A -	N/A -	N/A -	N/A -

## Anioxide 1000 - instrument disinfectant

ANIOS high-level total disinfection of surgical, medical and endoscopy equipment, heat-sensitive materials and medical devices.

### ➤ Composition

Extemporaneous production of peracetic acid from acetyl-caprolactam (PHERA system). ANIOXIDE 1000 generator contains 3% hydrogen peroxide.

### ➤ Instructions for use

- Clean and rinse all instruments very thoroughly before soaking in ANIOXYDE 1000 (activated solution)
- Before using for the first time, wait at least 30 minutes
- Check the peracetic acid level with an ANIOXYDE 1000 strip
- Soaking time: 10 minutes (30 minutes for spores)
- Rinse very thoroughly with sterile or filtered water



Cat. No.	Description	Units/box	Price/box
059669	Anioxide 1000, 5 l canister	4	N/A -
059669A	Anioxide 1000, 5 l canister	1	N/A -

## Neutral disinfectant detergent DDN9

- **For pre-disinfection of instruments: recommended for hollow instruments with complex shapes**
- **Suitable for ultrasonic tanks**
- **Antibacterial and yeasticidal**

Cat. No.	Description	Price
711514B	Disinfectant detergent DDN9, 5 litre canister	N/A -
711515	Disinfectant detergent DDN9, 1 litre bottle	N/A -
711516	Disinfectant detergent DDN9, 250 x 25 ml bags	N/A -





## Steranios 2% and Opaster'Anios - Total cold disinfection of instruments



- **Instructions for use**
- Ready to use: do not dilute
  - Clean and rinse all instruments very thoroughly before soaking
  - Soaking time according to the desired efficiency spectrum:
    - bactericidal, fungicidal, virucidal: 20 minutes
    - sporicida: 1 hour

Cold disinfectant for instruments.

► **Steranios 2%**

- **Simple: no neutral pH activator**
- **Effective: bactericidal, fungicidal and virucidal in 20 minutes, sporicidal in 1 hour**

► **Opaster'Anios**

- **High level disinfectant for thermosensitive medical devices**
- **Bactericidal, virucidal, fungicidal, and mycobactericidal activity in 5 minutes**
- **Anti-corrosive effect on metals sterile or filtered 0.2 µm**
- **Wide compatibility with all types of materials**
- **Active on Clostridium Difficile 0127**

### Steranios 2%

Cat. No.	Description	Price
059604	Steranios 2%, 5 litre canister	N/A -
059605	Steranios 2%, 4 x 5 litre canister	N/A -

### Opaster'Anios

Cat. No.	Description	Price
059917A	Opaster'Anios, 5 litre canister	N/A -
059917	Opaster'Anios, 4 x 5 litre canisters	N/A -
059987	Control strips - tube of 50	N/A -

## ANIOS soaking bins



Soaking containers for collection, pre-disinfection of instrumentation.

- **Two models: 2 and 5 litres**
- **For use with SterAnios and Aniosyme DD1**
- **2 litre version with or without slot on the lid**

Cat. No.	Model	Int. dim. (mm)	Ext. dim. (mm)	Price
059815	2 l.	230 x 170 x 90	295 x 200 x 130	N/A -
059817	2 l. with slot	230 x 170 x 90	295 x 200 x 130	N/A -
059816	5 l.	365 x 255 x 125	430 x 290 x 125	N/A -

## Autoclavable soaking container



- **For pre-disinfection and disinfection**
- **Polypropylene tray autoclavable at 134 °C for 18 minutes**
- **Equipped with a fish bowl and a lid**

Cat. No.	Description	Dimensions L x W x H (mm)	Volume (l)	Price
972534	Tray	257 x 180 x 128	3	N/A -
972536	Bin + tray	890 x 200 x 145	12	N/A -

## Non-autoclavable soaking container



- **For pre-disinfection and disinfection**
- **Equipped with a fish bowl and hollow handles**
- **Transparent anti-splash lid for easy insertion of objects without opening the lid**

Cat. No.	Description	Dimensions L x W x H (mm)	Volume (l)	Price
972538	Tray	550 x 200 x 120	5	N/A -
972539	Container without tap	390 x 290 x 170	10	N/A -
972540	Container with tap	615 x 400 x 220	30	N/A -

## DNA-ExitusPlus and DNA-ExitusPlus IF - RNase-ExitusPlus

### DNA-ExitusPlus

For decontamination in 10 minutes at temperatures of 20 °C or above. For the decontamination of surfaces, equipment, plastics and glassware as well as pipettes. Simply apply the product to the surfaces to be decontaminated or dip the containers in the decontaminant. Instructions for use supplied with the product. Based on bio-degradable compounds. Incorporates a coloured indicator to identify the treated surface before wiping (IF version without indicator).

### DNA-ExitusPlus

Volume	100 ml	500 ml	1 l	2.5 l
Spray	049918	049920	-	-
Price	N/A -	N/A -	-	-
Bottle	-	-	049922	049923
Price	-	-	N/A -	N/A -

### DNA-ExitusPlus IF

Volume	100 ml	500 ml
Spray	049927	049929
Price	N/A -	N/A -



### RNase-ExitusPlus

Non-alkaline, non-corrosive, non-carcinogenic, highly active cleaning solution for RNase contamination. Stable for about 18 months and heat resistant. Biodegradable, non-toxic compounds. Mineral acids and alkaline substances that are not harmful to equipment even after long incubation times. A temperature of about 50 °C will increase the reaction rate. Store at room temperature.

Volume	500 ml	1 l	2.5 l
Spray	049912	-	-
Price	N/A -	-	-
Bottle	-	049914	049915
Price	-	N/A -	N/A -

## RNase Away and DNA Away

Remove all traces of RNase and DNA!

### ➤ RNase Away

Ready to use, RNase Away solution avoids any risk of RNase contamination. In spray bottle or bottle.

### ➤ DNA Away

To remove all traces of DNA from PCR workstations, benches and equipment. Ready to use.

### RNase Away spray bottle and flask

Description	Spray bottle 475 ml	Bottle 250 ml	Bottle 1 litre	Bottle 4 litres
Cat. No.	038184	038185	038186	038187
Price	N/A -	N/A -	N/A -	N/A -

### DNA Away bottle

Cat. No.	Description	Price
038188	250 ml bottle of DNA Away	N/A -



## Decontaminant DNADecon

- Highly effective decontamination solution for the removal of DNA and RNA contamination from surfaces, instruments and laboratory equipment
- Ideal for decontamination of PCR workplaces, as it destroys and completely removes DNA molecules from any surface
- Can also be used for decontamination of electrophoresis chambers, pipettes, reaction tubes, etc.

### ➤ Advantages: ready to use, non-alkaline, non-carcinogenic

Cat. No.	Description	Price
215445	250 ml Spray bottle	N/A -
215446	500 ml Refill	N/A -



## Incubator-Clean™



PanReac  
AppliChem  
ITW Reagents

Disinfectant solution for incubators, sterile cell culture benches and molecular biology laboratories. Prevents contamination and growth of fungi and spores, yeast, bacteria and spores, mycoplasma and viruses (including HIV and Hepatitis B).

- **Active ingredient:** benzylammonium quaternary
- **Nontoxic and biodegradable**
- **Compatible with most work surfaces:** aluminium, chrome, nickel steel, polycarbonate..
- **Sterile, filtered solution in a spray bottle**
- **Storage:** at room temperature
- **Stability:** minimum 3 years
- **Recommendations for use:**
  - incubators: spray incubators every 15 days
  - dry without leaving any residue, so there is no need to rinse
  - sterile benches: to be used before each manipulation on the bench

Cat. No.	Type	Price
670931	Incubator Clean 500 ml	N/A -

## Incuwater-Clean™



Disinfectant for use in incubator water tanks.

- **Non-toxic, non-volatile**
- **Does not damage stainless steel or copper trays in CO<sub>2</sub> incubators**
- **Conditions of use:** add 50 ml of Incuwater-Clean to the water tank with sterile water - repeat every fortnight

PanReac  
AppliChem  
ITW Reagents

Cat. No.	Type	Price
670934	Incuwater Clean 100 ml	N/A -

## Aquabator-Clean™ (100x)



Disinfectant for use in water baths against bacteria and fungi.

- **Operating conditions:** 10 ml per litre of water - change water every 4-6 weeks and add aquabator-clean every 1-2 weeks
- **Stable at 100 °C**
- **Biodegradable**

PanReac  
AppliChem  
ITW Reagents

Cat. No.	Type	Price
670935	Aquabator Clean (100x) 250 ml	N/A -

## Disinfectant for water baths Réa-Stabil



Concentrated bactericidal disinfectant for water baths and thermostatic baths. The results are even better with distilled or demineralised water.

- **Efficiency:** 2 to 3 months
- **Water colouring:** blue
- **Very economical:** 1 ml per litre (10 ml for a 10 litre bath)
- **Biodegradable**
- **Components:** biguanides surfactants and dye

Cat. No.	Description	Price
074022	Bottle of 200 ml Réa-Stabil	N/A -

## Autoclave cleaner



- **Weak acid to be used diluted to clean autoclaves**
- **For use on walls and also for cleaning water tanks**

Cat. No.	Description	Price
032204	Autoclave cleaner 1 l	N/A -

## Mycoplasma - prevention



### Biogard S

- **Surface disinfectant**
- **Compatible with all types of surfaces**
- **Free of Alcohol, phenol and formaldehyde**
- **Non-toxic and biodegradable**

Cat. No.	Description	Vol.	Price
500176	Biogard S Surface disinfectant spray	1 l	N/A -



### Biogard A disinfectant for CO<sub>2</sub> incubator water tank

- **Non-toxic, non-volatile**
- **Compatible with stainless steel**

Cat. No.	Description	Vol.	Price
500177	Biogard A disinfectant for waterbaths and CO <sub>2</sub> incubators	100 ml	N/A -



## Aquanet water bath stabiliser

Stabiliser for water baths, with an original formula, very effective in particular against the proliferation of bacteria, it prevents the appearance of unpleasant odours.

- **Composition:** Didecyldimethylammonium chloride - CAS No. 7173-51-5: Concentration 15 % (m/m) / Benzalkonium chloride - CAS No 68424-85-1: Concentration 10% (m/m)
- **Appearance:** liquid
- **Odour:** odourless
- **Colour:** blue
- **pH of the delivered product:** Weak base
- **pH of the product diluted in water to 2%:** 9.3 (+/- 0.5)
- **Compatibility:** 135 °C at a pressure of 2.5 bar
- **Dosage:** 100 ml for 3 litres of water
- **Efficiency:** 2 months



Cat. No.	Description	Price
063103	Aquanet bottle 100 ml	N/A -
063104	Aquanet bottle 1 litre	N/A -

### Activity:

- bactericidal: EN1276 (dirt conditions - 0.5 % - 5 min - 20 °C), EN 13697 (dirt conditions - 0.5 % - 5 min - 20 °C), NF EN 13727 (dirt conditions - 0.5 % - 5 min - 20 °C), NF EN 14561 (dirt conditions - 1 % - 5 min - 20 °C)
- yeasticidal: EN1650 (dirt conditions - 0.25 % - 15 min - 20 °C), EN 13697 (dirt conditions - 0.25 % - 15min - 20 °C), EN 13624 (dirt conditions - 0.5 % - 5 min - 20 °C), NF EN 14562 (dirt conditions - 0.5 % - 15min - 20 °C)
- sporicidal: EN 13704 on Bacillus subtilis and Clostridium difficile (cleanliness conditions - 5% - 60 min - 20 °C)
- virucidal: EN 14476 on PRV\*, BVDV\*, H1N1, (dirt conditions - 2% - 5min - 20 °C) Herpes, Vaccinia virus, Rotavirus (dirt conditions - 0.5% - 5 min - 20 °C), Norovirus (dirt conditions - 2% - 15 min - 20 °C), HIV (dirt conditions - 2% - 60 sec - 20 °C)
- \*Swine Pseudorabies Virus (PRV) and Bovine Viral Diarrhea Virus (BVDV) are substitutes for HBV and HCV

## Tablets and granules for disinfection of Haz-Tab solutions

- **Tablets against viruses, bacteria and fungi**
- **Absorbent and disinfectant granules**
- **Made from sodium dichloroisocyanurate (NaDcc)**

Cat. No.	Description	Price
074025	Tube of 100 Haz-Tab tablets	N/A -
140237	Haz-Tab Granules - 500 g tube	N/A -



## Anios'R Odour Destroyer

- **Odour destroyer, fragrance after-effect**
- **Cleans and pleasantly perfumes washable floors and surfaces for many hours**
- **750 ml (odour destroying spray) or 5 litre (bactericidal detergent/disinfectant) versions, and 50 ml bottle**
- **2 perfumes: Fresh garden or Sun way**
- **No rinsing required**



Perfume	750 ml bottle	20 x 50 ml bottles	5 litre canister with pump
Fresh garden	059797	059865	059799
Sun way	059798	059864	059800
Price	N/A -	N/A -	N/A -

## Odo clave



- **Odour neutraliser**
- **Sachet to be placed in the autoclave**
- **Format 32 x 32 mm**

Cat. No.	Perfume	Price 100 units
085953	Clove	N/A -
085954	Cherry	N/A -
085955	Pine	N/A -
085956	Lemon	N/A -

## Deodoriser for autoclave

A range of deodorisers that can be used to neutralise odours in the autoclave.

Cat. No.	Description	Volume (ml)	Units/box	Price/box
150280	Classic Autoclave Deodorant (capsules)	-	100	N/A -
150281	Poma Autoclave Deodorant (capsules)	-	100	N/A -
150282	Citrus Autoclave Deodorant (capsules)	-	100	N/A -
150321	Anabac Peach Deodorant (capsules)	-	100	N/A -



## Anios Multi-Surface Cleaner



➤ **Multi-surface cleaner for daily maintenance of surfaces**

➤ **Instructions for use**

- ready-to-use product;
- spray the solution on the surface to be cleaned or on the microfibre used to apply the product to the surface;
- wipe off and allow to dry;
- no rinsing required unless the surface is likely to come into contact with foodstuffs.

➤ **Composition**

- surfactant in hydroalcoholic medium;
- declaration according to regulation (CE) n° 648/2004;
- contains less than 5% non-ionic surfactants and also contains perfume and lactic acid;
- surfactants of plant origin.

➤ **Physico-chemical data**

- fluid liquid;
- density at + 20 °C: 1.001;
- pH of the pure product at + 20 °C: 6.13;
- storage between + 5 °C and + 30 °C.



Cat. No.	Description	Price
059662B	Anios Multi-Surface Cleaner - 750 ml	N/A -

## Phagospray DM Surface disinfectant



Disinfectant detergent spray for non-invasive medical devices and their surfaces.

Anti-microbial activity: EN 1040, EN 1276, EN 13697, EN13727.

Fungicidal: standard EN 1275 (C.albicans), EN 13697 (C.albicans), EN 13624 (C.albican).

Mycobactericidal: EN 14348 (M.avium).

Virucidal: EN 14476 on Rotavirus and Influenza A virus H1N1, HIV, HBV.

➤ **Clear, colourless liquid**

➤ **Grapefruit scent**

➤ **pH at 20 °C (pure product): 10.5 +/- 0.5**

➤ **Use undiluted, do not rinse**

➤ **Spray on a disposable cloth and apply to the surface**

Cat. No.	Description	Price
972499	Phagospray DM 750 ml with sprayer	N/A -
972500	Phagospray DM 5 litres without sprayer	N/A -

## Virkon Disinfectant Cleaner



Disinfectant cleaner in effervescent tablets or in powder form, to be dissolved in water, based on monopersulfate and sulfamic acid. Apply by wet cleaning or spraying on floors and surfaces.

➤ **pH = 2.6 / proven effectiveness: bactericidal, fungicidal, virucidal, sporicidal**

➤ **Dose for use: 1 %, i.e. one tablet per 500 ml, or one bag per 5 litres**

Cat. No.	Description	Pack unit	Price/ sales unit
972472	Virkon 5 g tablets	box of 50	N/A -
972473	Virkon 50 g doses	50 doses bag	N/A -
972497	Virkon 5 kg bucket	1 bucket	N/A -

## Anios DTS Cleaning Stain Remover



➤ **Cleans and removes stains from all washable surfaces**

➤ **Instructions for use:**

- Ready-to-use solution;
- Spray the surface to be cleaned;
- Leave the product to work;
- Wipe with a single-use paper or microfiber;
- Rinse with drinking water when the surface comes into contact with unpackaged foodstuffs.

Cat. No.	Description	Price
059805B	Anios DTS Multi-Purpose Stain Remover - 750 ml bottle	N/A -

## Multi-surface cleaner



➤ **Cleans all surfaces thoroughly, without scrubbing**

Cat. No.	Volume (ml)	Price
280009	750	N/A -

# SURFACE DISINFECTANTS

## Aniospray Surf 29 - disinfectant spray

- Disinfection of previously cleaned surfaces, medical equipment and non-immersible, non-invasive medical devices
- Ready to use: active on enveloped viruses in 1 minute
- Leaves no trace when drying and no greasy film after spraying
- Clear, colourless solution
- pH at +20 °C: approx. 5.5
- Spray pressure: 1 ml of product

- **Instructions for use**
  - Spray directly onto the surface
  - Leave the room closed for at least 15 minutes



	12 x 1 litre bottles with 4 sprayers	4 x 5 litre canisters
Cat. No.	059844	059845
Price	N/A -	N/A -

## Aniospray Quick - spray disinfectant

- Ready to use
- Broad spectrum activity in a short time
- Does not leave traces after drying
- Pleasant smell
- No aldehyde, no colour
- pH at 20 °C: 5.5
- **Instructions for use**
  - Clean the room with Anios disinfectant detergent beforehand
  - Spray evenly
  - Leave without contact for 30 seconds



	12 x 1 litre bottles with 4 sprayers	4 x 5 litre canister
Cat. No.	059915	059916
Price	N/A -	N/A -

## Incidin Oxyfoam S sporicidal spray disinfectant cleaner

- For surfaces and instruments
- Ready-to-use product sporicidal, virucidal, bactericidal, fungicidal
- Hi-Speed H<sub>2</sub>O<sub>2</sub>, technology, based on hydrogen peroxide
- Disinfectant cleaner for medical devices (DM class IIb) and surfaces (Biocide Group 1-TP2)
- Alcohol free
- **Instructions for use**
  - Spray directly onto the surface from a distance of about 30 cm
  - Allow to dry



Cat. No.	Description	Price
059983A	Incidin Oxyfoam S - Spray bottle 750 ml	N/A -

## Isopropyl alcohol 70% "Biocide"

- Biocidal effect
- For body (healthy skin) and surface disinfection

Cat. No.	Packaging	Price
280018A	Spray 110 ml	N/A -
280019A	Spray 100 ml	N/A -
280020A	1 l bottle	N/A -
280017A	2 l bottle	N/A -
280021A	5 l bottle	N/A -
280014B*	Blister pack of 10 wipes	N/A -

\*sold by 24 blisters of 10 wipes





## Surfa'Safe premium - surface disinfectant foam



- Disinfectant detergent foam for cleaning and disinfecting surfaces
- Bactericidal, fungicidal, virucidal
- **Instructions for use**
  - Apply the disinfectant detergent foam to the surface
  - Spread the foam
  - Respect the contact time according to the desired antimicrobial activity
  - Allow to dry
  - Do not rinse (except for surfaces in contact with foodstuffs, skin or mucous membranes)



	Compact foam	Diffuse foam	scented formula
Cat. No. 750 ml bottle	059841	059842	059843
Price	N/A -	N/A -	N/A -

## Isopropyl alcohol 70% IP sterile



- Isopropanol PE compliant
- Made with WFI or purified water
- Filtration at 0.2 µm
- Radiosterilized
- Double packaging
- Endotoxin < 0.25 UI/ml

Cat. No.	Packaging	Price
059956A	1 l bottle	N/A -
059957A	Spray 400 ml	N/A -

## Disinfectant detergent FB Spray



- For the bio-cleaning of high surfaces
- Ready to use, compatible with food contact surfaces
- neutral pH (pH 6+/-1)
- Based on non-ionic surfactants and didecyldimethylammonium chloride
- CMR-free, dye-free, fragrance-free
- Active on Bacillus subtilis and Clostridium difficile



Cat. No.	Description	Units/box	Price/box
711575	FB spray 750 ml	12	N/A -

## VIROSPRAY virucidal disinfectant cleaner



- For cleaning and disinfection of reusable and non-immersible medical devices
- Bi-alcohol combination for an enhanced activity spectrum
- Fast drying and streak-free, no rinsing required
- Bactericidal, yeast-killing, tuberculocidal, virucidal activities
- Formulation based on amphoteric surfactant, alkylamine in alcoholic solution; aldehyde-free and quaternary ammonium-free
- pH 7



Cat. No.	Description	Units/box	Price/box
711584B	Viro spray 1 l	6	N/A -

## Anios Quick'Wipes



- Impregnated with a fast-acting disinfectant solution for previously cleaned, alcohol-resistant, non-immersible and non-invasive medical devices and surfaces
- Aldehyde-free, dye-free formulation
- Ready-to-use wipes
- **Instructions for use**
  - Apply the wipe to the area to be treated
  - Respect the contact time indicated for the desired antimicrobial activity
  - Rinsing is not necessary unless there is prolonged contact with the skin or mucous membranes
  - Close the package tightly after each opening

Cat. No.	Description	Price
059863	Anios Quick'Wipes - box of 120	N/A -

## Aspetto Biocide Wipes



- Cleaning wipes for surfaces
- Virucidal, bactericidal and fungicidal actions

Cat. No.	Packaging	Price
280007	Dispenser for 40 wipes	N/A -
280008	Dispenser for 100 wipes	N/A -

# SURFACE DISINFECTANTS

## Acusat IPA 75% disinfectant wipes

- IPA 75% impregnated wipes
- Fast and optimal membrane penetration of viruses and bacteria
- Virucidal EN 14476
- Do not leave residues or traces after wiping
- For the disinfection of instruments and surfaces
- Wipes size: 16 x 20 cm



Cat. No.	Description	Price
133016A	Acusat 75% IPA wipe - bag of 50 wipes	N/A -

## Disinfecting wipes for food contact

- Wipes impregnated with a quaternary ammonium solution
- Bactericidal, yeasticidal, fungicidal, virucidal activities
- Food contact compatible: TP2 and TP4 biocides
- For the disinfection of instruments and surfaces
- Wipes size: 32 x 20 cm



Cat. No.	Description	Price
133017A	Acusat Virucidal Wipe TP2 & TP4 - bag of 40 wipes	N/A -

## Wip'Anios Excel wipes

- Disinfecting wipes for the treatment of surfaces and medical devices
- Made of 100% biodegradable viscose
- Alcohol-free, fragrance-free impregnation solution
- Broad virucidal spectrum
- Microbial efficiency from 3 minutes
- Type 4 biocide for use on food contact surfaces

### Instructions for use

- Apply the wipe to the area to be treated
- Allow to dry
- Rinse only if the areas to be treated come into contact with the skin, mucous membranes or foodstuffs



	Bag of 50	Bag of 100
Cat. No.	059849	059850
Price	N/A -	N/A -

## Bactinyl® odourless disinfectant wipes

- For contact disinfection of non-invasive medical devices, instrumentation, medical materials and equipment
- Suitable for disinfecting healthy skin
- Medical device class IIa
- Disinfectant solution based on hydrogen peroxide, quaternary ammoniums, ethanol
- Format: 165 x 400 mm

### Bactericidal activity:

- EN 13727 (dirt conditions - 1 min, 20 °C)
- EN 14561 (dirt conditions - 5 min, 20 °C)
- EN 16615 (dirt conditions - 2 min +/- 15 sec, 20 °C)

### Yeast killing activity:

- EN 13624 (dirt conditions - 1 min, 20 °C)

### Virucidal activity:

- EN 14476



Cat. No.	Description	Price/ box of 120 wipes
011501	Odourless disinfectant wipes	N/A -

## Meliseptol® Disinfecting Detergent Wipes



- Made of polyethylene terephthalate, free of alkaline, dyes and perfumes
- Detergents and disinfectants impregnated with pure Meliseptol® Foam
- Broad virucidal spectrum
- Size (mm): 200 x 152

### Instructions for use

- Apply the wipe to the area to be treated
- Allow to dry
- In case of visible contamination: 2-step procedure
  - decontamination with a wipe
  - disinfection with a new wipe

	Box of 60 wipes	Bag of 60 wipes
Cat. No.	921114	921115
Price	N/A -	N/A -

## Anios Floor Cleaner



- Floor cleaner for daily cleaning of floors and surfaces
- Respect the precautions for use (established according to the European directive 99/45/CE)
- Information available on the safety data sheet and the label

### ➤ Instructions for use

- concentrated product to be diluted to 0.25%;
- use one 20 ml dose for an 8 litre bucket of water;
- apply the solution to the surface to be cleaned using a flat mop;
- let it dry.

### ➤ Composition

- declaration according to regulation (CE) n° 648/2004;
- contains 5% or more, but less than 15% of non-ionic and anionic surfactants, less than 5% of phosphonates, also contains perfume;
- colourless to very slightly yellow liquid;
- density at + 20 °C: 1.027;
- pH of the pure product at + 20 °C: 9;
- storage between + 5 °C and + 35 °C.

Cat. No.	Description	Price
059661B	Anios Floor Cleaner - 1 litre	N/A -

## Déterg'Anios - Cleaning of floors and surfaces



Over-odorizing detergent with high cleaning power.

- Persistent deodorant effect
- Wetting, dispersing and solubilising effect on organic and mineral soils
- No rinsing
- Cleaning of all types of surfaces, glossy, protected or not, in hospitals
- Compatible with disinfectant detergents

### ➤ Instructions for use

- Dilute to 0.25%, i.e. 20 ml or one pump pressure per 8 litres of cold or warm water

Cat. No.	Description	Price
059644B	Deterg'anios 1 l dispensing bottle	N/A -
059664	Deterg'anios bottle, 500 doses of 20 ml	N/A -
059665B	Deterg'anios 4 x 5 litres + 1 dosing pump	N/A -
059665BA	Deterg'anios, 5 litre bottle	N/A -



## DETER Surf Neutral detergent for floors and surfaces

- Compatibility with a wide range of materials
- Dilution: 0.25% (20 ml/8 l) in cold or hot water
- No rinsing
- pH neutral: 7.7 (pure)
- Based on anionic and non-ionic surfactants
- Available unscented or with lemon scent

Cat. No.	Description	Colour	Price
711537	Deter Surf SP unscented - 1 l canister	Blue	N/A -
711572	Deter Surf SP unscented - 5 l canister (4 units)	Blue	N/A -
711570A	Deter Surf Lemon GB - 1 l canister	Green	N/A -
711571	Deter Surf Lemon GB - 5 l canister (4 units)	Green	N/A -



## Duotex - ready-to-use disinfectant cleaner

- Cleaning and disinfection of all surfaces
- Non-flammable, CMR-free, environmentally friendly
- Compliant with food contact without rinsing (TP4)
- Ready to use
- Bactericidal, yeasticidal, virucidal activities

Cat. No.	Description	Price
7130236	Duotex wipes - bucket of 500 wipes	N/A -
7130233	Duotex sprayer 750 ml	N/A -
7130234	Duotex 1 l bottle	N/A -
7130235	Duotex 5 l canister	N/A -



## Aniosurf ND Premium - floor and surface disinfection

- Cleaning and disinfection of floors, walls and equipment
- Broad anti-microbial effectiveness
- Non-corrosive formulation compatible with washable surfaces
- Dries without traces or sticky residue
- Can be used in cold or warm water

### Instructions for use

- To be diluted to 0.25%: i.e. a dose of 20 ml in 8 litres of water

Perfume	500 x 20 ml doses	1 litre bottle	4 x 5 litre canisters + pump
Citrus	059833	059834A	059835
Price	N/A -	N/A -	N/A -



## Anios Oxy'Floor - floor and surface disinfectant detergent

- Broad spectrum cleaning and disinfection for floors and surfaces, including those that may come into contact with foodstuffs
- Odourless powder
- Simultaneous cleaning and disinfecting action
- Active on clostridium difficile in 15 minutes
- Alternative to chlorine
- Single dose: avoids overdose

### Instructions for use

- 0.5% dilution, i.e. a dose of 25 g in 5 litres
- Storage of the solution: 8 hours

	100 doses of 25 g	1 kg bucket
Cat. No.	059861	059862
Price	N/A -	N/A -



## Désintex BGF - aldehyde-free disinfectant detergent



Suitable for all materials, protected and unprotected floors and above ground. Combines high-capacity cleaning elements with a synergy of broad-spectrum disinfectant families.

- ▶ Bactericidal according to EN 1040-1276 (dirt conditions), fungicidal according to EN 1275 (Candida albicans), virucidal according to EN 14476 (Adenovirus type 5, clean conditions)
- ▶ Active on influenza viruses H<sub>1</sub>N<sub>1</sub> and H<sub>5</sub>N<sub>1</sub>
- ▶ Complies with the decree of 08/09/1999 on cleaning products for materials in contact with foodstuffs
- ▶ Biodegradable in accordance with EU Regulation 648/2004
- ▶ Labelling according to the labour and/or transport code
- ▶ Dosage: 0.25 %

Cat. No.	Packaging	Price
7130230	5 litre transparent polyethylene drum	N/A -
7130231	1 l dispensing bottle/20 ml dose	N/A -

## Surfanios Premium - Disinfectant detergent for floors and surfaces



- ▶ Product combining detergent and disinfectant actions
- ▶ Effective on bacteria and moulds isolated from the hospital environment
- ▶ Formulated without aldehyde
- ▶ Optimisation of ecotoxicological data
- ▶ No rinsing
- ▶ **Instructions for use**
  - To be diluted to 0.25%: 20 ml or one pump pressure for 8 litres of water

Cat. No.	Description	Price
059783	Surfanios Premium - 1 l dispensing bottle	N/A -
059784	Surfanios Premium - 4 x 5 l canisters with 20 ml dosing pump	N/A -
059840	Surfanios Premium - 2 x 5 l canisters + 2 pumps	N/A -
059782	Surfanios Premium - 500 x 20 ml bags	N/A -

## One Shot Bactericidal



- ▶ Bactericidal and fungicidal formula approved to EN1276 and EN1650
- ▶ Allows to treat a volume up to 50 m<sup>3</sup>
- ▶ Active 5 minutes after the product has been applied

Cat. No.	Volume (ml)	Price
280022A	50	N/A -
280023	150	N/A -

## Aseptanios AD ready-to-use disinfectant



- ▶ Stabilised solution of peracetic acid and hydrogen peroxide
- ▶ Bactericidal, fungicidal, yeasticidal, sporicidal

Cat. No.	Description	Price
059790	Aseptanios AD - 2 l canister (set of 4 x 2 l canisters)	N/A -
059790A	Aseptanios AD - 2 l Canister	N/A -

## Vet'Anios - specific pet range

Broad spectrum disinfectant detergent.  
For the treatment of floors, surfaces and materials.

### Aniosyme Synergy WD high efficiency detergent

Highly effective detergent for cleaning surgical and medical equipment and medical devices.

- For automatic washing machines and washing tunnels
- Effective in soft and hard water
- Tri-enzymatic complex effective on many soils
- Density: 1.16
- Clear yellow liquid

#### Instructions for use

- Use at dilutions of 0.2% and 0.5%
- Effective from 1 minute
- Maximum operating temperature: 60 °C



Cat. No.	Description	Price
061414	Aniosyme Synergy WD - 5 l canister (2 units)	N/A -

### Anios'Clean Excel D

Pre-scrubbing detergent for medical surgical instruments. Suitable for heat-sensitive instruments.

- High level of detergency
- Efficient even in hard water
- Non-corrosive
- Clear blue solution
- pH of the pure product: 7

#### Activities at 20 °C:

- Bactericidal in 5 min at 0.5% (EN 13727, EN 14561)
- Levuricidal in 15 min at 0.5% (EN 13624, EN 14562)
- Tuberculocidal in 60 min at 2% (EN 14348, EN 14563)

#### Instructions for use

- Concentrated solution, to be used at a dilution of 0.5% (5 ml/l)
- Soake the material for some minutes in the soaking bath
- Rinse thoroughly
- Renew the soaking bath at least once a day



Cat. No.	Description	Price
059932	Anios'Clean Excel D - 1 l dispensing bottle (6 unit)	N/A -
059933	Anios'Clean Excel D - 5 l canister with pump (2 unit)	N/A -

## Phagosurf ND Disinfectant Floor and Surface Detergent

Disinfectant detergent for surfaces: floor, furniture and non-surgical equipment.

- Anti-microbial activity: standard NF EN 1040, standard NF EN 1276
- Fungi: methodology NF EN 1275, C.albicans
- Viruses: methodology vs. HIV, HBV: scientific file on request.

- Chemical nature of the active ingredient of the product: quaternary ammonium, amphoteric, coactive agents
- Liquid appearance: clear green / Odour: fresh lemon
- pH (20 °C - 0.25 % dilution of mains water): ~ 9.4

#### Instructions for use

- Dilute in cold water from 0.125% to 0.25% for heavy soiling
- Pour in water first, then a 10 ml or 20 ml measure per 8 l of water
- Allow to dry after 15 min. application without rinsing or wiping according to protocol

Cat. No.	Description	Price
972488	Phagosurf ND - 5 litre canister (2 units)	N/A -





## Sanilair air pollution control



- Spray to restore healthy, invigorating air
- Microemulsion with essential oils
- Adsorption and removal of malodours
- Ethyl alcohol free (VOC < 2%)
- Botanically and biochemically defined essential oils

Perfume	Spray 200 ml	500 ml sprayer
Garrigue (thyme, rosemary, mint, eucalyptus)	005600A	005601A
Citrus (mandarin, orange, bergamot)	005604A	005605A
Lavender (lavender, bergamot, lemon)	005602A	005603A
Hypoallergenic (special formulation for sensitive/allergic people: cedar, wild thyme, myrrh, vanilla, amyris, patchouli)	005606A	005607A
Price	N/A -	N/A -

## Aeroseptin 4



- "One shot" spray disinfectant for surfaces and furniture
- Bactericidal and yeasticidal: effective in 1 minute according to EN 1040 and EN 1275

Cat. No.	Description	Price
711568A	Aeroseptin 4 - 50 ml bottle	N/A -

## HPderm® 500 Cleaner



Mild cleanser for frequent washing of sensitive and reactive skin.

- Enriched with plant lipoamino acids, which regenerate the epidermis
- Solvent and abrasive free
- Fragrance and dye free
- Pouches 061913 only work with dispenser 061915
- Developed, manufactured and controlled under pharmaceutical supervision
- Soap free

### Uses

- Frequent cleaning at the work station
- Collectivities, food and agriculture
- Household hygiene

Cat. No.	Description	Price
061912	HPderm 500 - 1 litre bottle	N/A -
061913	HPderm 500 - 1 litre pouch	N/A -
061915	Dispenser for pouches	N/A -

## Anios Concept CPA Dispensers



059968



059971

- Electronic or manual wall mounted dispensers
- Side view window
- Key lock system

Type	White	Grey	Price
Manual dispenser	059968	059969	N/A -
Electronic dispenser	059970	059971	N/A -

## Consumables for distributors Concept CPA



059976

- 1 l square retractable bottle
- Sealed bulbs

Cat. No.	Description	Units/box	Price/box
059972	Aniosgel 85 NPC	12	N/A -
059973	Aniosgel 800	12	N/A -
059975	Aniosafe Manuclear HF	12	N/A -
059976	Aniosafe Manuclear NPC HF	12	N/A -

## Aniosafe Manuclear HF Hand Wash Solution

Simple hand washing solution for frequent use.

- **Made without allergens and enriched with moisturising substances, without perfume or colouring agents**
- **Protective effect against possible microbial pollutants**
- **Softer than mild soap**

Cat. No.	Description	Units/box	Price/box
059648	500 ml bottle with white pump 1.5 ml	12	N/A -
059649	1 litre bottle with pump	12	N/A -
059649A	1 litre bottle with pump	1	N/A -
059803	Airless 1 litre bottle	12	N/A -
059803A	Airless 1 litre bottle	1	N/A -
059804	5 litres canister	1	N/A -



## Liquid Marseille soap

- **Traditional Coprah-Olive manufacturing**
- **Gentle and effective skin cleansing**
- **Unscented formula for sensitive skin**
- **Fragrant formulas with essential oils and refreshing power**

	pump-bottle 500 ml	Pump-bottle 1 l	5 l canister
<b>Perfume</b>			
Garrigue (thyme, rosemary, mint, eucalyptus)	005628A	005629A	005630A
Citrus (mandarin, orange, bergamot)	005631A	005632A	005633A
Lavender (lavender, bergamot, lemon)	005634A	005635A	005636A
<b>Price</b>	N/A -	N/A -	N/A -
Neutral fragrance	005638A	005639A	005640A
<b>Price</b>	N/A -	N/A -	N/A -



## Phagoderm® Sensitive Soap

Foaming solution for simple and frequent washing.

- **Suitable for sensitive skin**
- **Hypoallergenic**
- **Paraben-free, dye-free, fragrance-free, phenoxyethanol-free**

Cat. No.	Description	Price
972569	Pump bottle 500 ml	N/A -



## HPDerm superfatted soap for sensitive skin

- **For the daily hygiene of sensitive skin**
- **Soap base of vegetable origin enriched with moisturising and protective active ingredients of natural origin (shea oil, glycerine)**
- **High tolerance formula for face and body, hypoallergenic, no added fragrance**

Cat. No.	Description	Price
061938A	HPDerm Superfatted Soap - 150g bar	N/A -



## HP derm 7 Lotion



Foaming lotion for hygienic hand washing.

- Enriched with a natural superfatting agent
- Fragrance-free, paraben-free, dye-free
- Allows for frequent washing
- Ideal for sensitive or reactive skin
- Bactericidal (EN 1040), Fungicidal on Candida Albicans (NFT 72-301)
- Developed, manufactured and controlled under pharmaceutical supervision
- Uses: hygienic hand washing, medical, paramedical and hospital environments, food industry

Cat. No.	Description	Price
061925	HP Derm 7 lotion - 500 ml pump bottle	N/A -
061926	HP Derm 7 lotion - 1 l bottle	N/A -
061927B	HP Derm 7 lotion - 800 ml pouch - pack of 2	N/A -
061915	Dispenser for pouches 1 l	N/A -
061928	HP Derm 7 lotion - 5 l canister	N/A -
061929	Pump for 1 l bottle	N/A -
061917	Metal wall dispenser for 1L bottle	N/A -

## Baktolin Pure Hand Cleansing Lotion



Gentle hand wash.

- No dyes, no perfume
- pH neutral for the skin (approx. 5.5)
- Soap free, alkali free, paraben free
- Mild surfactants
- Can be taken with a dispenser or in a bottle with pump (not supplied)

Cat. No.	Description	Price
684356	Baktolin pure, 500 ml bottle	N/A -
684357	Baktolin pure, 1 l bottle	N/A -
684358	Baktolin pure, 5 l canister	N/A -

## Estesol Hand Cleaner



Liquid skin cleanser with high cleaning power.

- Good skin compatibility
- Deep cleaning of all light soiling
- Incorporates a conditioning agent to smooth the skin
- Soap free
- Slightly acidic pH
- For use with the Vario ULTRA dispensers

Cat. No.	Description	Price
678318	Estesol, 2 l cartridge	N/A -
678320	Vario ULTRA soap dispenser	N/A -

## Frapantol Hand Cleaner



Special creamy skin cleanser for gentle cleansing.

- Good skin compatibility
- Deep cleaning of all light soiling
- Dermatologically tested
- Incorporates a conditioning agent to smooth the skin
- No soap, no perfume, no dye
- Slightly acidic pH
- LaFleur European Ecolabel
- For use with Vario ULTRA soap dispensers

Cat. No.	Description	Price
678319	Frapantol, 2 l cartridge	N/A -
678320	Vario ULTRA soap dispenser	N/A -



## Dermanios Scrub CG

Antiseptic for hygienic and surgical washing of healthy skin.

- **Good skin tolerance, pH close to that of the skin**
- **Perfect for frequent use**
- **Applications**
  - Allows to fight against the transitional microbial flora responsible for possible contaminations
- **Instructions for use**
  - Hygiene treatment: 3 ml dose
  - Surgical disinfection: 2 x 3 ml dose
  - Get your hands wet
  - Apply a dose of soap
  - Rub hands and forearms for at least 1 minute.
  - Rinse hands for at least 30 seconds
  - Dry hands with a single-use towel



Cat. No.	Description	Price
059643	Dermanios Scrub CG, 12 x 500 ml bottles + pumps	N/A -
059643A	Dermanios Scrub CG, 1 x 500 ml bottle + pump	N/A -
059656	Dermanios Scrub CG, 12 x 1 litre bottles + pumps	N/A -
059656A	Dermanios Scrub CG, 1 x 1 litre bottle + pump	N/A -
059801	Dermanios Scrub CG, 12 x 1 litre bottle Airless	N/A -
059801A	Dermanios Scrub CG, 1 x 1 litre bottle Airless	N/A -
059802	Dermanios Scrub CG, 1 x 5 litre bottle	N/A -

## Dermanios Scrub Chlorhexidine 4% - antiseptic foaming solution



- **Pre-operative whole body washing and disinfection**
- **Chlorhexidine-based formulation (4%)**
- **Hygienic hand washing: 3 ml / 30 sec (EN 1499)**
- **Surgical wash: 2 x 3 ml / 5 minutes (EN 12791)**
- **product pH: pH 5,5 +/- 0.5**
- **Alcohol free**
- **Viscosants and emollients: better skin tolerance**

	100 x 30 ml bottles	12 x 500 ml bottles	12 x 1 litre bottles with pump	12 x 1 litre airless bottles
Cat. No.	059866	059867	059868	059869
Price	N/A -	N/A -	N/A -	N/A -

## HP derm 7 gel

Hydroalcoholic gel for the hygienic treatment and disinfection of hands.

- **Enriched with glycerine, prevents the skin from drying out**
- **Fragrance-free, paraben-free, dye-free**
- **Allows for a reduction in hand-carried contamination and can be used away from any water source**
- **Bactericidal (EN 1040), Fungicidal on Candida Albicans (EN 1275), Virucidal (NFT 72180)**
- **Developed, manufactured and controlled under pharmaceutical supervision**
- **Uses: hand disinfection, medical, paramedical and hospital environments, food industry**

Cat. No.	Description	Price
061922B	HP Derm 7 gel - 800 l bottle pouch - 2 pack	N/A -
061915	Dispenser for 1 l pouches	N/A -
061917	Metal wall dispenser for 1 l bottle	N/A -



**TIP**

See also our disinfectant wipes or spray pages 1285 to 1293

## Aniosgel 85 NPC

### ➤ Instructions for use

- Hygienic treatment: 3 ml (2 pump strokes) for 30 sec. friction time. Rub in until completely dry. Do not rinse
- Surgical disinfection: 2 x 4.5 ml (2 x 3 pump strokes) for a total rubbing time of 3 min. Rub in until completely dry. Do not rinse.

Cat. No.	Description	Price
059812	Aniosgel 85 NPC, 1 bottle 100 ml	N/A -
059950	Aniosgel 85 NPC, 1 blue bottle 300 ml + 1 pump 3 ml screw	N/A -
059951	Aniosgel 85 NPC, 1 blue bottle 500 ml + 1 pump 3 ml screw	N/A -
059952	Aniosgel 85 NPC, 1 blue bottle 1 l + 1 pump 3 ml screw	N/A -
059953	Aniosgel 85 NPC, 1 blue bottle 1 l airless	N/A -
059667	Airless plastic holder	N/A -

Thixotropic hydroalcoholic gel for hygienic treatment and surgical disinfection of hands by friction.

- **Incorporates moisturising and skin-protecting agents**
- **Has a broad antimicrobial spectrum including activity on Poliovirus in 30 seconds**
- **Aniosgel 85 NPC is formulated without dyes or perfumes**
- **Active on H<sub>1</sub>N<sub>1</sub>**
- **Pump 3 ml**



## Aniosgel 800



Ready-to-use thixotropic hydroalcoholic gel for the hygienic treatment and surgical disinfection of hands.

- **Broad antimicrobial spectrum including activity on poliovirus in 30 sec.**
- **Preventing the spread of antimicrobial resistance**
- **Fragrance-free, dye-free**
- **Suitable for sensitive skin**
- **Preserves the skin's moisture**

Cat. No.	Description	Price
059908	Aniosgel 800 squeeze bottle 30 ml	N/A -
059909	Aniosgel 800 squeeze bottle 100 ml	N/A -
059910	Aniosgel 800 bottle 300 ml + 3 ml screw-in pump	N/A -
059911	Aniosgel 800 bottle 500 ml + 3 ml screw-in pump	N/A -
059912	Aniosgel pump bottle 1 l	N/A -
059913	Aniosgel airless bottle 1 l	N/A -

## Aniosgel 85



Thixotropic hydroalcoholic gel for hygienic treatment and surgical disinfection of hands by friction.

- **Hypoallergenic formula**
- **Free of allergenic substances**
- **Broad antimicrobial spectrum: active on bacteria, yeast, moulds and viruses**
- **Hygienic treatment: 3 ml / 30 sec**
- **Surgical disinfection: 2 x 3 ml / 2 x 45 sec.**
- **Does not require a water point**

Cat. No.	Description	Price
059825	Aniosgel 85 blue, 1 bottle 100 ml	N/A -
059820	Aniosgel 85 blue, 1 bottle 300 ml + 1 pump 1.5 ml	N/A -
059632	Aniosgel 85 blue, 1 bottle 500 ml + 1 pump 1.5 ml	N/A -
059826	Aniosgel 85 blue, 1 bottle 1 litre + 1 pump 1.5 ml	N/A -
059827	Aniosgel 85 blue, 1 bottle 1 litre Airless	N/A -
059828	Holder for 300 ml bottle	N/A -
059829	Holder for 500 ml bottle	N/A -

## Phytogel efficiency - alcohol-free hand disinfectant gel



- **Alcohol-free formulation**
- **Bactericidal, fungicidal, yeasticidal, virucidal activities; contact 1 minute**
- **Hand protection (avoids skin dryness, irritation)**
- **With essential oils**

Phytogel - alcohol-free disinfectant gel	Cat. No.	Units/box	Price/box
Spray bottle 10 ml	005608	100	N/A -
Spray bottle 50 ml	005610A	1	N/A -
Pump bottle 500 ml	005611A	1	N/A -
Pump bottle 1 l	005612A	1	N/A -
5 l canister	005613A	1	N/A -

## Phagorub SPS Gel



- **Controlled viscosity suitable for hygienic friction**
- **Fragrance-free, dye-free and preservative-free**
- **Special for sensitive skin**
- **Active ingredient: ethanol**
- **Bactericidal, fungicidal, virucidal**

Cat. No.	Description	Volume (ml)	Units/box	Price/box
972521	Doses	5	250	N/A -
972522	Flasks	100	30	N/A -
972526	Airless bottles	1000	12	N/A -

## Phagorub hydroalcoholic solution

For hand disinfection by friction.

- **Bactericidal, fungicidal, virucidal (effective in 15 seconds)**
- **72% ethanol - no phenoxyethanol, no preservatives and no colourants**

### Activities:

- Bactericidal: EN 1040, EN 1500, EN12791
- Fungicidal: EN 1275 sur C.albicans, EN 1650 on C.albicans
- Virucidal: EN 14476 (BVDV, Vaccinia virus, HBV-HCV-HIV, Influenza A/ H<sub>5</sub>N<sub>1</sub>, Influenza A/ H<sub>1</sub>N<sub>1</sub>, Rotavirus)

### Uses

- As an alternative to simple hand washing or hygienic washing
- in the absence of water outlets
- during serial contact
- Before any aseptic procedure or in a controlled atmosphere zone

Cat. No.	Description	Price
972502B	Phagorub - 500 ml mounted pump	N/A -
972503	Phagorub - 1000 ml Airless	N/A -



## Hydroalcoholic gel

Cat. No.	Volume (ml)	Price
280005	200	N/A -
280006	100	N/A -



## Hydroalcoholic gel for hand disinfection

Ready-to-use gel for the hygienic treatment and disinfection of hands.

- **Bactericidal, yeasticidal and virucidal activity**
- **Dries instantly, does not stick**
- **Effective against H<sub>1</sub>N<sub>1</sub>**
- **100 ml or 300 ml bottle**
- **300 ml bottle with pump**

Cat. No.	Packaging	Price
011507	Bottle 100 ml with dispenser cap	N/A -
011506	Bottle 300 ml with mounted pump	N/A -



## Biocidium Gel +

- **Hydroalcoholic antiseptic gel**
- **No rinsing**
- **Contains aloe vera and glycerine**
- **Fragrance-free, dye-free**

Cat. No.	Description	Units/box	Price/box
711529	100 ml bottle	1	N/A -
711531	500 ml bottle with pump	1	N/A -
711578	1 l bottle with pump	6	N/A -
711579	1 l bottle Airless	12	N/A -



## Manuphyl Intensive Repair Hand Cream

- **Repairs and protects hands that have been badly damaged by cold, humidity, washing, work, irritating substances, etc**
- **Non-greasy, non-staining formula enriched with wheat protein and glycerine**
- **Delicately scented, suitable for sensitive skin**
- **Helps maintain the skin's natural pH and normal moisture levels**
- **Apply a dab of cream to clean, dry hands 1 to 3 times a day**

Cat. No.	Description	Price
062416A	Manuphyl intensive hand repair cream - tube 50 ml	N/A -

Product available in 1 l bottle, consult us.





## MANUPHYL® Protective Cream



MANUPHYL is a moisturising and protective cream for hands that have been damaged and dried out by frequent washing or wearing gloves.

- **Protects, moisturises and penetrates quickly**
- **Non-greasy, unscented**
- **Maintains the physiological pH balance of the skin**
- **With vegetable lipoamino acids, lanolin-free**
- **Paraben-free, dye-free and fragrance-free**
- **Hand cream with allantoin**
- **Developed, manufactured and controlled under pharmaceutical supervision**

### ➤ Uses

- Skin sensitised by cold or frequent washing
- All work situations that cause irritation and minor injuries
- Can also be used for daily prevention

Cat. No.	Description	Price
061906	Manuphyl - tube 100 ml	N/A -
061907	Manuphyl - pouch SORIBAG 800 ml*	N/A -

\*SORIBAG wall mounted pouch dispenser

### Wall-mounted dispensers for pouches, cartridges and bottles

SORIBAG 800 ml pouches are to be used with the wall-mounted dispensers provided, which can either be glued or fixed to the wall. The pouches are airtight, which guarantees the quality of the cream throughout their use. Fixing kits supplied.

Cat. No.	Description	Price
061915	Dispenser for 800 ml pouches (red, blue or transparent)	N/A -
061917	Metal dispenser for 1 litre bottle	N/A -



## Skin protective cream



Protection of the skin from repeated aggression due to working conditions.

- **Enriched with superfatting and moisturising agents**
- **Discreet fragrance**

Cat. No.	Description	Price
059651	50 ml Bottle	N/A -
059652	100 ml Tube	N/A -
059668A	500 ml bottle and pump	N/A -

## ANTHYDRO® water barrier cream



Protective cream to be applied before work and specially designed for people who frequently work with water or aqueous solutions (detergents, etc.).

- **Protects from aqueous environments**
- **Low fat, unscented**
- **Developed, manufactured and controlled under pharmaceutical supervision**

### ➤ Uses

- Repeated contact with water, aqueous acid or alkaline solutions, brines, soluble oils
- Maintenance and cleaning agents
- Agri-food sector

Cat. No.	Description	Price
061900	Anthydro - 125 ml tube	N/A -

## PHYPROL® anti-solvent gel



Hydroalcoholic gel that protects the skin from solvents and water-immiscible products.

- **Solvent resistant**
- **Protects the skin's hydrolipidic layer**
- **Unscented**
- **Developed, manufactured and controlled under pharmaceutical supervision**

### ➤ Uses

- Organic solvents (white spirit, toluene, hexane, etc.)
- Ketone compounds
- Glues, resins, varnishes, solvent-based paints
- Water-insoluble cutting oils

Cat. No.	Description	Price
061904	Phyprol - tube 125 ml	N/A -

## LIBAL® Multi-Purpose Protective Cream



Multi-purpose protective cream that protects the skin from aqueous and non-aqueous solutions.

- **Silicone-free hand, arm and face cream**
- **Protects against aqueous or solvent-based media**
- **Fast penetration**
- **Preserves the skin's natural buffering capacity**
- **Developed, manufactured and controlled under pharmaceutical supervision**

### ➤ Uses

- Water and aqueous, acid or alkaline solutions
- Paints, varnishes, resins, cements
- Certain solvent mixtures
- All types of cutting oils, moulding, locked...

Cat. No.	Description	Price
061902	Libal - 50 ml tube	N/A -



## Cabinets for acids and bases



571010B



571015B

- External steel construction, epoxy coated
- Melamine lining and non-metallic venting to resist corrosion
- Swing doors with security locks
- Seals on doors and air ducts to prevent the release of harmful fumes
- Sliding shelves with a removable, waterproof PE drip tray
- Permissible distributed load per shelf: 25 kg
- Retention Volume: 15 l/bac
- Connection Ø 75 mm, for ventilation system on top of the cabinet (strongly recommended, see page 1308)



The safety cabinets are delivered carriage paid to the quay.  
For delivery on the first floor, please consult us.

Type	Tall cabinets		Underbench cabinets	
Model	SL.196.120	SL.196.60	SL.60.110	SL.59.60
No. of doors	2	1	2	1
Compartment No.	2	2	2	1
out.Ø (W x D x H) (mm)	1200 x 605 x 1970	600 x 605 x 1970	1100 x 570 x 600	590 x 570 x 600
inn.Ø / compartment (W x D x H) (mm)	485 x 565 x 1865	485 x 565 x 930	485 x 550 x 530	480 x 530 x 560
Weight (kg)	160	125	60	40
Interior equipment	8 sliding shelves	-	2 sliding shelves	1 sliding shelves
Cat. No.	571009B	-	571013C	571016B
Price	N/A -	-	N/A -	N/A -
Interior equipment	12 sliding shelves	4 sliding shelves	-	2 sliding shelves
Cat. No.	571010B	571011B	-	571015C
Price	N/A -	N/A -	-	N/A -

## Combined cabinet with 30 min fire resistance NF EN 14470-1



- Two separate inner compartments for storing flammable liquids and chemicals in one cabinet
- Door holding system included
- Transport base with plinth for easy movement
- Security lock with interchangeable barrel
- Shelves adjustable in height in 32 mm increments
- Permissible distributed load per shelf: 75 kg
- Connection Ø 75 mm for ventilation system on top of the enclosure (strongly recommended, see page 1308)
- Certified to NF EN 14470-1

Model	K-30.197.120.MV.FWAS
Fire protection	30 min
Ext. Dim. W x D x H (mm)	1197 x 617 x 1969
int. Dim. W x D x H (mm)	-
Weight (kg)	-
Left compartment (flammable liquids)	3 shelves Gratings Floor retention tray 27 l
Right compartment (Acids and bases)	4 metal-free tray shelves Plastic tray 15 l
Cat. No.	571121
Price	N/A -



The safety cabinets are delivered carriage paid to the quay.  
For delivery on the first floor, please consult us.



## Fire resistant cabinets 30 min glass door NF EN 14470-1

- Cabinets with glass door for quick viewing of containers
- Fire resistant for 30 minutes
- Width: 86 cm
- Grey body and door with a choice of 3 colours: yellow, grey, red
- Automatic door closure by means of an integrated thermofuse in the event of fire
- Doors remain open in any angle
- Transport base for easy movement and optional plinth
- Permissible distributed load per shelf: 75 kg
- Connection Ø 75 mm for ventilation system on top of the enclosure (strongly recommended, see page 1308)
- Dimensions L x D x H (mm) 864 x 620 x 1947
- Weight of cabinet without internal equipment: 212 kg
- Supplied with 3 shelves, 1 grating and 1 floor drain tray



Q-DISPLAY-30 cabinet with filter chamber (filter chamber shown as an option on page 1308)

### Accessories

Cat. No.	Description	Price
571162	Additional shelf	N/A -
571163	On a shelf box	N/A -
571164	Base cover panel	N/A -



Door colour	Yellow	Grey	Red	Price
Cat. No.	571159	571160	571161	N/A -

## Fire resistant under-bench cabinets 30 min or 90 min NF EN 14470-1

- Steel outer body
- Chemical-resistant interior lining
- Doors or drawers with lock(s)
- Connection Ø 75 mm for ventilation system at the rear of the cabinet (strongly recommended, see page 1308)



571043B



The safety cabinets are delivered carriage paid to the quay. For delivery on the first floor, please consult us.

Type	Model 90 min			Model 30 min	
	VBF.60.110-S	VBF.60.110-2S	VBF.60.110-T/01110	F30.60.110-S	UB30.60.110.2T
Fire protection	90 min	90 min	90 min	30 min	30 min
Number of doors/drawers	1 drawer	2 drawers	2 doors	1 drawer	2 doors
Ext. Dim. W x D x H (mm)	1102 x 574 x 600	1102 x 574 x 600	1102 x 574 x 600	1100 x 550 x 598	1100 x 550 x 598
int. Dim. W x D x H (mm)	979 x 453 x 502	479 x 453 x 502	978 x 452 x 502	930 x 481 x 534	980 x 482 x 534
Weight (kg)	120	120	120	120	120
Interior equipment	Retention tray integrated in the drawer		Retention tray gratings	Retention tray integrated in the drawer	Retention tray gratings
Cat. No.	571043B	571042B	571044C	571036B	571140
Price	N/A -	N/A -	N/A -	N/A -	N/A -

## 90 min fire resistant cabinets NF EN 14470-1 with hinged doors



- Steel outer body
- Chemical-resistant interior lining
- Door holding system included
- Security lock with interchangeable barrel
- Shelves adjustable in height in 32 mm increments
- Permissible distributed load per shelf: 75 kg
- Connection Ø 75 mm for ventilation system on top of the enclosure (strongly recommended, see page 1308)
- Certified to NF EN 14470-1



The safety cabinets are delivered carriage paid to the quay.  
For delivery on the first floor, please consult us.

Model	S90.196.120.WDAS	S90.196.060.WDAS
Fire protection	90 min	90 min
Number of hinged doors	2	1
out.Ø (W x D x H) (mm)	1200 x 615 x 1968	600 x 615 x 1968
inn.Ø (W x D x H) (mm)	1050 x 520 x 1740	450 x 520 x 1720
Weight (kg)	420	260
Interior equipment	3 shelves, 1 retention tray and 1 grating and door holder	
Cat. No.	571024C	571025C
Price	N/A -	N/A -
Additional shelf	571046B	571045B
Price	N/A -	N/A -

## Q-Classic fire resistant security cabinets 90 min or 30 min NF EN 14470-1

## Model 90 min:

- Ext. dim. (W x D x H): 1193 x 615 x 1953 mm
- Int. dim. (W x D x H): 1050 x 522 x 1647 mm
- Weight: 424 kg

## Model 30 min:

- Ext. dim. (W x D x H): 1164 x 620 x 1947 mm
- Int. dim. (W x D x H): 1050 x 519 x 1626 mm
- Weight: 240 kg

- Automatic door closure by means of an integrated thermofuse in the event of fire
- Doors remain open in any angle
- Transport base for easy moving, optional removable plinth
- Shelves adjustable in height in 32 mm increments
- Permissible distributed load per shelf: 75 kg
- Connection Ø 75 mm for ventilation system on top of the cabinet (strongly recommended, see page 1308)
- Supplied as standard with 3 shelves (1040 x 432 x 30 mm), 1 retention tray 33 l and 1 grating



Door colours	Model 90 min		Model 30 min	
	Cat. No.	Price	Cat. No.	Price
Yellow	571094C	N/A -	571114B	N/A -
Grey	571095C	N/A -	571115B	N/A -
Red	571096C	N/A -	571116B	N/A -
Blue	571097C	N/A -	571117B	N/A -
Green	571098C	N/A -	571118B	N/A -
Silver	571099C	N/A -	571119B	N/A -
White	571100C	N/A -	571120B	N/A -

## Accessories

Cat. No.	Description	Price
571046B	Additional shelf (dim.: 1040 x 432 x 30 mm)	N/A -
571101B	Base cover panel	N/A -
571102B	Q-Mover 2-piece set (for easy transport of Q-cabinets through standard height doors)	N/A -

The safety cabinets are delivered carriage paid to the quay.  
For delivery on the first floor, please consult us.

## V-LINE fire resistant cabinet 90 min

- Reduced width cabinet, only 45 cm thanks to the drawer: space-saving, optimal storage capacity almost identical to conventional cabinets with 90 cm wide doors
- Tall cabinet with 1 vertical drawer
- Motor-assisted drawer opening and automatic closing after 60 seconds
- Overview of the stored products with easy access from the right or left side of the drawer
- Key lock of the drawer
- Ventilation holes DN75 for connection to a filter or self-contained ventilation system
- Equipped with 4 or 5 shelves, 1 grating and 1 retention tray 11-litre to the floor
- Colour: anthracite grey body and drawer colour to be chosen or unicolour model in grey or white
- Fire resistant for 90 minutes according to EN 14470-1
- Ext. Dimensions W x D x H (mm) 450 x 863 x 1966



Model Unicolour white

Drawer colour	Model with 1 vertical drawer 4 shelves		Model with 1 vertical drawer 5 shelves	
	Cat. No.	Price	Cat. No.	Price
Yellow	571207	N/A -	571212	N/A -
Grey	571208	N/A -	571213	N/A -
Red	571209	N/A -	571214	N/A -
Blue	571210	N/A -	571215	N/A -
Silver	571211	N/A -	571216	N/A -
Cabinet, unicolour: grey	-	-	571218	N/A -
Cabinet, unicolour: white	571219	N/A -	571220	N/A -

### Accessory

Cat. No.	Description	Price
571235	Safety rails for 1 shelf	N/A -

## Combined cabinet with 90 min fire resistance NF EN 14470-1

- Two separate inner compartments for storing flammable liquids and chemicals in one cabinet
- Door holding system included
- Security lock with interchangeable barrel
- Shelves adjustable in height in 32 mm increments
- Permissible distributed load per shelf: 75 kg
- Connection Ø 75 mm for ventilation system on top of the enclosure (strongly recommended, see page 1308)
- Certified to NF EN 14470-1



Model	K90.196.120.MF.FWAS	
Ext. Dim. W x D x H (mm)	1197 x 617 x 1969	
Int. Dim. W x D x H (mm)	1050 x 524 x 1742	
Weight (kg)	515	
Left compartment (flammable liquids)	3 shelves Gratings Floor retention tray 22.5 l	3 shelves Gratings Floor retention tray 22.5 l
Right compartment (Acids and bases)	4 shelf trays without metal Plastic tray	6 shelf trays without metal Plastic tray
Cat. No.	571002C	571049B
Price	N/A -	N/A -

## Refrigerated safety cabinet UB-S-90

- Under-bench cabinet with refrigeration system for keeping products in a refrigerated environment
- Fire resistance 90 min EN 14470-1
- Ventilation system with activated carbon filter for retention of solvent vapours
- Pull-out drawer with lock and stainless steel drip tray; ergonomic: remains open (regardless of opening)
- Load capacity 50 kg
- Maximum refrigeration capacity: 2 °C
- Ext. dim. W x D x H: 1108 x 574 x 630 mm / Dim. int. W x D x H: 980 x 450 x 500 mm
- Weight: 180 kg



Cat. No.	Description	Price
571122	Refrigerated safety cabinet UB-S-90	N/A -

The safety cabinets are delivered carriage paid to the quay. For delivery on the first floor, please consult us.





## ASECOS combi underbench cabinet

571104



571103

- **2 in 1: storage of flammable and aggressive substances in 1 cabinet**
- **Compartment for the storage of flammable hazardous substances:**
  - Easy handling, doors or drawers can be opened without too much effort
  - Doors and drawers remain open in any position
  - Self-closing door or drawer in case of fire
  - Lockable doors or drawers
- **Compartment for the storage of aggressive, non-flammable substances:**
  - Lockable doors
  - 2 sliding shelves with removable retention trays

Model	2 doors	1 drawer and 1 door
Ext. Dim. W x D x H (mm)	1100 x 500 x 600	1100 x 500 x 600
Int. Dim. W x D x H (mm)	2 x (470 x 450 x 500)	2 x (470 x 450 x 500)
Left compartment (flammable liquids)	Hinged door Floor retention tray with grating and shelf	Drawer Tray Drawer
Right compartment (corrosives)	2 sliding shelves with retention trays	2 sliding shelves with retention trays
Cat. No.	571104B	571103
Price	N/A -	N/A -

## Recirculating air filter system for solvent vapours



571008B

For filtering solvent vapours from cabinets.  
Only for fire resistant tall cabinet 90 min.

- Audible and visual alarm
- Automatic monitoring of the filter saturation rate
- Delivered ready to use

Cat. No.	Model	Description	Price
571008B	UFA.020.030	Recirculating air filter system for retaining solvent vapours	N/A -

## Accessory

Cat. No.	Description	Price
571056B	Replacement filter	N/A -

## Soundproof extraction unit



571052B

- To extract vapours from safety cabinets
- Air exchange in the cabinet up to 120 times per hour
- Quick assembly

Cat. No.	Model	Description	Price
571057B	HF.EA.8677	Standard unit	N/A -
571058B	HF.EA.11442	Unit with airflow control* - Power kW 0.035	N/A -

## Units for under-bench cabinets

Cat. No.	Model	Description	Price
571053B	HF.EA.15575	Wall-mounted unit with airflow control*	N/A -
571052B	HF.EA.11570	Standard soundproof ventilation unit for wall mounting	N/A -

\*Flow control: In case of fan malfunction or pressure drop, the green light goes off and the red light comes on.

## Filtration chambers



571004

For filtering vapours from safety cabinets.

- NFX 15-211 (1996) on the walls for toxins with recirculation of filtered air (ETRAF)
- Extremely effective filter with activated charcoal
- Saturation rate of filter controlled by taking manual samples
- Supplied ready to use with 1 metre of hose, 2 collars Ø 80 mm, a connector cable and a socket

Cat. No.	Model	Description	Price
571051	EPL.53048	Chamber for solvents	N/A -
571004	EPL.53049	Chamber for corrosives	N/A -

## Accessories

Cat. No.	Model	Description	Price
571074	EPL.53050	AS spare filter for solvents	N/A -
571075	EPL.53051	BE spare filter for corrosive products	N/A -

Chambers with specific filters for predominantly formaldehyde vapours, high particle efficiency or for powders on request.

## Safety cabinets for poisons

Specially designed for the storage of poisons. Can be used as a wall cabinet or as a poison chest within a large cabinet.

- 10/10 construction
- Epoxy paint RAL 9010
- Standard symbols
- Key lock

Cat. No.	H x L x D (mm)	Storage Capacity	Number of Shelves	Weight (kg)	Price
060037	380 x 470 x 205	12 l	2	10	N/A -
060036	580 x 470 x 205	19 l	4	15	N/A -



See also our medicine cabinets on page 1191

## 10 and 20 litre safety cabinets

Specially designed for the storage of small volumes of flammable products and other solvents. Optional CO<sub>2</sub> fire extinguisher with automatic activation in case of fire in accordance with CNPP FSE 98-006 specifications.

- Standard symbols
- Automatic key lock
- Made from steel coated with epoxy paint RAL 1013
- Sloping roof prevents uncontrolled storage
- Shelf on retention tray
- Integrated retention tray
- Supplied with a 120 gram fire extinguisher



Cat. No.	External dimensions H x L x D (mm)	Internal dimensions H x L x D (mm)	Storage Capacity	Retention capacity	Number of Shelves	Retention tray	Weight (kg)	Price
060091	455 x 500 x 250	260 x 490 x 220	10 l	10 l	1	1	12	N/A -
060092	500 x 700 x 250	260 x 690 x 220	20 l	15 l	1	1	20	N/A -

## Under-bench security cabinet, 30 litre

Specially designed to store your hazardous materials under laboratory benches. Available in versions for flammable, corrosive (acids and bases) or toxic products.



- 15/10<sup>th</sup> steel construction with double-walled door
- Epoxy paint
- Standard symbols
- Steel shelves and drip trays
- PVC over-shelf and drip tray for the acid model (AC<sub>30</sub>)
- Ventilation holes
- Key lock
- Options: swivel castors, forced ventilation

Cat. No.	For products	External dimensions H x L x D (mm)	Internal dimensions H x L x D (mm)	Storage Capacity	Retention capacity	Number of Shelves	Retention tray	Weight (kg)	Price
060084	Inflammables	670 x 550 x 500	650 x 530 x 470	30 l	28 l	1	1	30	N/A -
060086	Bases	670 x 550 x 500	650 x 530 x 470	30 l	28 l	1	1	30	N/A -
060087	Toxic	670 x 550 x 500	650 x 530 x 470	30 l	28 l	1	1	30	N/A -

Cat. No.	Description	Price
060088B	4 swivel castors, 2 of which are lockable, total height: 730 mm	N/A -
060089*	Integrated fan 90 m <sup>3</sup> /hour - 220 volts for acid, base or toxic models	N/A -
060090*	Control unit for fan M100/4	N/A -

\* not compatible with Cat. No. 060084

## Multi-risk modular cabinets



- Modular solution for product storage
- Compartment layout on request
- Epoxy painted steel construction
- Standardised pictograms
- Top and bottom ventilation
- 100 mm diameter roof outlet for possible connection (except 060330 and 060331 at the back)
- Height-adjustable steel retention shelf
- Removable steel drip tray at the bottom of each compartment



### Tall cabinets, width 560 mm

Doors	1 solid door	1 glass door	2 solid doors	2 solid doors	3 solid doors	3 solid doors
Compartments	1	1	2	2	3	3
Dimensions H x Wl x D (mm)	1825 x 560 x 545	1825 x 560 x 545	1825 x 560 x 545	1825 x 560 x 545	1825 x 560 x 545	1825 x 560 x 545
Storage Capacity	150	150	110	110	90	90
Retention capacity	40	40	70	70	90	90
Steel retention shelf	3 in steel	3 in steel	4 in steel	2 in steel and 2 in PVC	3 in steel	3 steel and 1 in PVC
Steel retention tray	1	1	2 in steel	1 in steel and 1 in PVC	3 in steel	2 in steel and 1 in PVC
Weight	60	60	65	65	70	70
<b>Cat. No.</b>	<b>060191</b>	<b>060295</b>	<b>060296</b>	<b>060285</b>	<b>060297</b>	<b>060160</b>
<b>Price</b>	<b>N/A -</b>	<b>N/A -</b>	<b>N/A -</b>	<b>N/A -</b>	<b>N/A -</b>	<b>N/A -</b>

### Tall cabinets, width 1120 mm

Doors	2 solid doors	2 glass doors	2 hinged doors	2 hinged glass doors	4 hinged doors	4 hinged glass doors
Compartments	1	1	2	2	4	4
Dimensions H x Wl x D (mm)	1825 x 1120 x 545	1825 x 1120 x 545	1825 x 1120 x 545	1825 x 1120 x 545	1825 x 1120 x 545	1825 x 1120 x 545
Storage Capacity	300	300	2 x 130	2 x 130	4 x 55	4 x 55
Retention capacity	80	80	2 x 40	2 x 40	4 x 35	4 x 35
Steel retention shelf	3 in steel	3 in steel	6 in steel	6 in steel	8 in steel	8 in steel and 2 in PVC
Steel retention tray	1 in steel	1 in steel	2 in steel	2 in steel	3 in steel	3 in steel and 1 in PVC
Weight	105	105	115	115	130	130
<b>Cat. No.</b>	<b>060298</b>	<b>060299</b>	<b>060322</b>	<b>060323</b>	<b>060324</b>	<b>060325</b>
<b>Price</b>	<b>N/A -</b>	<b>N/A -</b>	<b>N/A -</b>	<b>N/A -</b>	<b>N/A -</b>	<b>N/A -</b>

### Base cabinets, width 560 and 1120 mm

Doors	1 hinged door	2 solid doors	2 solid hinged doors	2 solid hinged doors
Compartments	1	2	2	2
Dimensions H x Wl x D (mm)	670 x 560 x 545	670 x 1120 x 545	670 x 1120 x 545	670 x 1120 x 545
Storage Capacity	30	-	2 x 30	2 x 30
Retention capacity	30	-	2 x 30	2 x 30
Steel retention shelf	1 in steel	1 in steel	2 in steel and 1 in PVC	2 in steel and 1 in PVC
Steel retention tray	1 in steel	1 in steel	2 in steel	2 in steel
Weight	25	48	50	50
<b>Cat. No.</b>	<b>060328</b>	<b>060329</b>	<b>060330*</b>	<b>060331**</b>
<b>Price</b>	<b>N/A -</b>	<b>N/A -</b>	<b>N/A -</b>	<b>N/A -</b>

Note: the safety cabinets are delivered free of charge (France) on the ground floor.  
For delivery on the first floor, please consult us.

\* model with standard fan, not suitable for storage of flammable products or solvents  
\*\* model without fan



## Anti-corrosion safety cabinets for acids and bases

- In white cellular PVC: perfect resistance to corrosive liquids and their vapours
- Ventilation holes Ø 100 mm top and bottom for connection
- Doors with key locks: hinged (960544, 960546 and 960548) or sliding (960545, 960547 and 960549)
- Feet with adjustment lift
- Sliding retention shelves



Cat. No.	Ext. dimension H x L x D (mm)	Number of compartments		Number of Shelves/ Retention bins		Storage Capacity (kg)	Retention capacity (l)	Weight (kg)	Price
		Main	Secondary	Main	Secondary				
960544	630 x 635 x 578	1	1	2	2	40	28	30	N/A -
960545	630 x 1135 x 578	2	0	4	0	72	44	60	N/A -
960546	900 x 635 x 615	2	2	6	6	120	84	90	N/A -
960547	1100 x 1135 x 615	2	0	6	0	100	66	110	N/A -
960548	1900 x 635 x 615	3	3	5	5	108	70	83	N/A -
960549	1900 x 1135 x 615	2	0	8	0	144	88	155	N/A -
060076	Additional shelf/sliding retention bin					20	11	6	N/A -

## 240 l safety cabinet for hazardous materials

For the storage of dangerous products.

- In 8/10<sup>th</sup> steel with grey paint RAL 7035
- Retention rack (H: 50 mm) supplied, height adjustable every 25 mm
- Retention bin at the bottom of the cabinet (H: 50 mm)
- Supplied with standardised pictograms
- Ventilation holes on the side
- Reminder: these cabinets are not suitable for storing highly corrosive products (nitric, sulphuric, hydrochloric acids, etc.). Consult us to find out which range of cabinets best suits your needs

Cat. No.	Dimensions H x L x D (mm)	Capacity of storage (l)	Capacity of retention (l)	Number of Shelves	Weight (kg)	Price
060287B	1800 x 920 x 420	240	80	4	60	N/A -

Note: the safety cabinets are delivered free of charge (France) on the ground floor.  
For delivery on the first floor, please consult us.



## 30 minute safety cabinets for flammable products



Specially designed for the storage of flammable products in accordance with EN 14470-1 (04/2004) and FM 6050.

- Insulated panel construction 38 mm thick
- Detachable drip tray in lower part
- Height-adjustable retention shelves
- Ventilation hole Ø 100 mm
- Standard symbols
- 3 door locks with key
- Door support system in open position with automatic closing in event of fire
- Meets the requirements of the American FM 6050 standard for the storage of flammable products
- 30 minutes fire resistance according to ISO 834 standard curve
- Models available with shelves or drawers

### 30 min shelving cabinets

Cat. No.	Ext. Dimensions W x D x H (mm)	Storage Capacity(l)	Retention capacity (l)	Number of doors	Number of Shelves	Number of Gratings	Weight (kg)	Price
060337	605 x 630 x 635	30	20	1	-	1	64	N/A -
060338	1115 x 630 x 635	60	41	2	-	1	108	N/A -
060339	605 x 550 x 1980	130	20	1	3	-	117	N/A -
060340	1115 x 550 x 1980	250	41	2	3	-	210	N/A -
060341	1092 x 537 x 1198	113	31	2	1	-	170	N/A -
060342	1092 x 457 x 1731	170	31	2	2	-	210	N/A -
060343	864 x 864 x 1731	228	54	2	2	-	210	N/A -

### 30 min drawer cabinets

Cat. No.	Ext. Dimensions W x D x H (mm)	Storage Capacity(l)	Retention capacity (l)	Number of doors	Number of drawers	Weight (kg)	Price
960328	605 x 550 x 1980	130	20	1	4	141	N/A -
960329	605 x 550 x 1980	130	20	1	5	147	N/A -
960330	605 x 550 x 1980	130	20	1	6	153	N/A -
960331	1115 x 550 x 1980	250	41	2	4	258	N/A -
960332	1115 x 550 x 1980	250	41	2	5	270	N/A -
960333	1115 x 550 x 1980	250	41	2	6	287	N/A -

## 30 min. safety cabinets with glass doors for flammable products



- 2 models with glass doors
- Immediate visualization of the products stored in the cabinet
- Tested and homologated to type 30 minutes in accordance with EN 14470-1
- Base with cover for easy movement by pallet jack when empty
- Ventilation holes Ø 100 mm for possible connection
- Door hold-open system with automatic closing in case of fire (thermal fuses)
- 3 door locks with key
- Lock with anti-spark lock
- Supplied with 3 shelves and 1 retention tray

Cat. No.	Ext. Dim. W x D x H (mm)	Storage Capacity(l)	Number of glass doors	Number of Shelves	Weight (kg)	Price
060391	605 x 550 x 1980	130	1	3	117	N/A -
060392	1115 x 550 x 1980	250	2	3	210	N/A -

## 30 minute multirisk cabinets - EN 14470-1 & FM

- ▶ 30 minutes fire resistance: tested and approved type 30 minutes to EN 14470-1
- ▶ Tested and approved 10 minutes to FM 6050 (Factory Mutual international)
- ▶ Separation by families of hazardous products
- ▶ Transport base with cover for easy transport with pallet jack (except for underbench model)
- ▶ 3-point key lock (non-sparking lock)
- ▶ Ventilation holes Ø 100 mm for possible connection
- ▶ Door holding system with automatic closing in case of fire
- ▶ Height-adjustable retention shelves in 32 mm increments
- ▶ Removable drip tray at the bottom

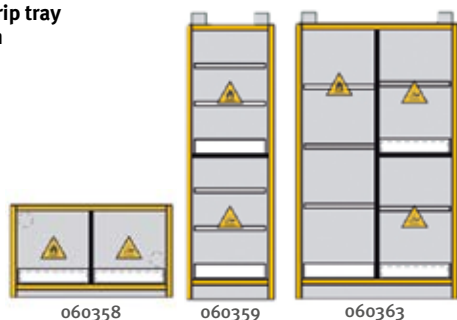

Cat. No.	Description	Ext. dimension H x L x D (mm)	Internal equipment			Weight (kg)	Price
			Retention shelf	Retention tray	Grating for bins		
060358	2-door under-bench cabinet with 2 compartments	635 x 1115 x 630	-	2	2	108	N/A -
060359	1 door tall cabinet with 2 compartments	1980 x 605 x 550	4	2	Option	126	N/A -
060360	1 door tall cabinet with 3 compartments	1980 x 605 x 550	3	3	Option	129	N/A -
060361	1-door tall cabinet with 4 compartments	1980 x 605 x 550	-	4	4	142	N/A -
060362	2-door tall cabinet with 2 compartments	1980 x 1115 x 550	6	2	Option	232	N/A -
060363	2-door tall cabinet with 3 compartments	1980 x 1115 x 550	7	3	Option	241	N/A -
060364	2-door tall cabinet with 4 compartments	1980 x 1115 x 550	6	4	Option	244	N/A -
060365	2-door tall cabinet with 4 compartments	1980 x 1115 x 550	8	4	Option	252	N/A -

## Safety cabinets with filtered ventilation

Ventilation/filtration system tested and approved to NF X 15.211. Self-contained cabinet ensuring your safety thanks to a filtration ventilation system adapted to the products stored.

- ▶ Made from steel coated with epoxy paint
- ▶ Standard symbols
- ▶ Perforated shelves and retention bin drawers at the bottom of the cabinet
- ▶ Key lock
- ▶ Glass doors for immediate viewing

### Accessories

Cat. No.	Description	Price
060120	Activated carbon filter for flammable vapours	N/A -
060112	Activated carbon filter for organic and corrosive vapours	N/A -



060109B

Cat. No.	Ext. dim. H x L x D (mm)	Int. dim. H x L x D (mm)	Storage Capacity(l)	Number of Shelves	Retention tray	Number of compartments	Weight (kg)	Price
060106B	1900 x 800 x 545	1500 x 780 x 500	140 litres	4	1	1	140	N/A -
060107B	1900 x 800 x 545	(2x) 1500 x 380 x 500	120 litres	8	2	2	150	N/A -
060108B	1950 x 1600 x 545	(2x) 1500 x 780 x 500	260 litres	8	2	2	280	N/A -
060109B	1950 x 1600 x 545	1500 x 780 x 500 + (2x) 1500 x 380 x 500	280 litres	12	3	3	290	N/A -
060119B	1950 x 1600 x 545	(4x) 1500 x 380 x 500	240 litres	16	4	4	300	N/A -



## Labopur® Recirculating air chambers



The electric fan allows the extraction of noxious and toxic vapours from the safety cabinets. The vapours are purified as they pass through the activated carbon filter and are then released into the atmosphere without harming the environment. Complies with NF X 15- 211.

- Construction in 12/10<sup>th</sup> steel and epoxy paint in white RAL9010 and blue RAL 5015
- Quiet fan 220/240 V, 20 W, 0.1 A, 43 dB, flow rate 86 m<sup>3</sup>/h
- Suction diameter (mm): 100
- Dust filter, 92% efficiency of particles > 3 µm
- Charcoal filter presence control screen
- Supplied without activated carbon filter\*

### Vertical chamber for under-bench cabinets

- For connection to under-bench cabinets (adaptable to all cabinets)
- Rear castors for easy movement

Cat. No.	Description	Dimensions H x L x D (mm)	Weight (kg)	Price
060469	Vertical chamber without filter	670 x 270 x 460	18	N/A -
060471	Multi-purpose activated carbon filter*	100 x 200 x 400	9	N/A -
060470	Activated carbon filter for organic vapours*	100 x 200 x 400	8	N/A -
060472	Activated carbon filter for formaldehyde vapours*	100 x 200 x 400	9	N/A -

\* Complete the diagnostic file for filter configuration

### Accessory

Cat. No.	Description	Price
060009	Connection kit for chamber	N/A -

### Options

- Activated carbon filter to be selected according to the products stored\*
- Connection kit for connection to the cabinet

## Ventilation and filtration chambers



For ventilating or filtering vapours in safety cabinets.

- Chamber with electric fan (220 v, 50 Hz)
- With or without activated carbon filter
- 100 mm suction diameter, optional chamber connection kit

Cat. No.	Activated carbon filter	H x L x D (mm)	Weight (kg)	Price
060008	No	225 x 400 x 195	11.5	N/A -

### Accessory

Cat. No.	Description	Price
060009	Connection kit for chamber	N/A -

Note: For delivery please consult us.

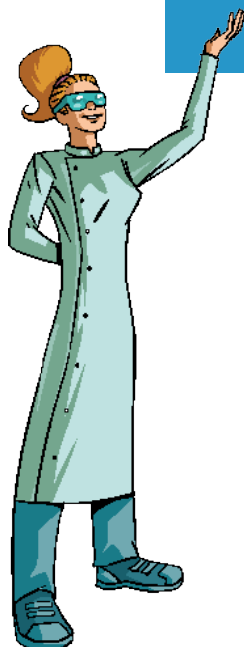



## Stainless steel serving trolley with wheels



- In 18/10 stainless steel
- 2 or 3 trays
- Delivered fully welded
- 4 wheels including 2 with brakes with electroplated tread
- Stainless steel tube diameter 25 mm

Cat. No.	Levels	Approximate dimensions L x D x H (mm)	Price
126004B	2	800 x 580 x 960 mm	N/A -
126005B	3	800 x 580 x 960 mm	N/A -
126204B	2	1000 x 670 x 960 mm	N/A -
126205B	3	1000 x 670 x 960 mm	N/A -

## Rack and tray dollies



- Stainless steel
- Useful dimensions (mm): 510 x 510
- Available with or without handle
- 4 swivel wheels Ø 100 mm
- Maximum load (kg): 80

Cat. No.	Description	Overall dimensions L x W x H (mm)	Price
909854	Stainless steel Rack dolly	515 x 515 x 165	N/A -
909855	Stainless steel Rack dolly with handle	600 x 515 x 850	N/A -

## Multipurpose trolleys



- Light grey
- Aluminium frame
- 2 or 3 polypropylene trays
- Load capacity: 100 kg/trolley and 60 kg/shelf

Cat. No.	Ext. dimension L x W x H (mm)	Int. dimensions L x W x H (mm)	Number of trays	Price
540040	485 x 365 x 720	480 x 360	2	N/A -
540041	485 x 365 x 720	480 x 360	3	N/A -

## Stainless steel trolleys



- 4 noise-reducing swivel wheels Ø 100 mm, 2 of which have brakes
- 4 corner stops
- Load capacity: 250 kg/trolley and 80 kg/shelf

Cat. No.	Ext. dimension L x W x H (mm)	Number of trays	Price
540042	930 x 610 x 935	2	N/A -
540043	930 x 610 x 935	3	N/A -
540044	710 x 405 x 810	2	N/A -

## Multipurpose plastic trolleys



- Aluminium frame and thick polypropylene trays
- Load capacity per shelf: 80 kg
- Load capacity per trolley: 250 kg
- 4 wheels Ø 100 mm, 2 of which have brakes
- Double ball bearing wheels
- Delivered unassembled, easy to assemble

No. of trays	Dimensions (W x L x H) (mm)	Black		Grey	
		Cat. No.	Price	Cat. No.	Price
2	850 x 480 x 950	040178	N/A -	040182	N/A -
3	850 x 480 x 1000	040179	N/A -	040183	N/A -
2	1100 x 520 x 950	040180	N/A -	040184	N/A -
3	1100 x 520 x 1020	040181	N/A -	040185	N/A -



## 6-wheel dollies

- ▶ Compatible with all 600 x 400 and 400 x 300 mm containers and crates
- ▶ High manoeuvrability and stability
- ▶ For loads up to 250 kg
- ▶ Steel axle and screws

Cat. No.	Description	Wheel material	Weight (kg)	L x W x H (mm)	Price
212056	6-wheel base	PP	2.87	613 x 414 x 135	N/A -
212057	Silent 6-wheel base	PA + rubber bandage	3.62	613 x 414 x 135	N/A -

### Stainless steel handle drawbar for wheel base

- ▶ Makes it easier to move heavy loads

Cat. No.	Description	Handle length (mm)	Weight (kg)	Price
212058	Stainless steel handle drawbar for 6-wheel base	960	1.1	N/A -



## Trolleys

### Standard trolley

- ▶ Smooth surfaces
- ▶ PP and aluminium tubes
- ▶ Withstands a load of 90 kg
- ▶ Dim.: 860 x 470 x 960 mm

Colours	White	Green	Price
Cat. No.	039672	039674	N/A -

### Large format trolley

- ▶ Scratch resistant surface
- ▶ White and aluminium colours
- ▶ Withstands a load of 135 kg
- ▶ Dim.: 1030 x 510 x 960 mm

Cat. No.	Description	Price
039675	Large format trolley	N/A -



## Folding trolley

- ▶ Practical for transporting files, small boxes, materials or tool boxes
- ▶ Aluminium frames and quality plastic trays
- ▶ Quickly folds down by means of a push button on the handle
- ▶ Mounted on 4 wheels: 2 pivoting at the front and 2 fixed with brakes at the rear
- ▶ Folds and unfolds easily
- ▶ Robust and handy
- ▶ Indoor and outdoor use
- ▶ Supplied with 1 folding 46 litre bin

Overall / folded height (mm)	1030 / 180
Overall / folded width (mm)	550 / 550
Overall / folded length (mm)	890 / 710
Upper/inf. tray Usable L x W (mm)	530 x 380 / 540 x 380
Upper/inferior tray force (kg)	20 / 40
Cat. No.	2004M11558
Price	N/A -



## Sterilisation cabinets

Stainless steel cabinet with rounded corners and transparent plexiglass door.

- ▶ Control knob at the bottom
- ▶ Timer from 0 to 2 hours
- ▶ Tube interruption device when doors are opened
- ▶ Key lock
- ▶ Protection class IP24

Cat. No.	Description	Dimensions L x D x H (mm)	Price
909851	Single door cabinet with magnetic bar	575 x 170 x 600	N/A -

### Replacement tube for cabinet length 575 mm

Cat. No.	Description	Price
909852	UV lamp, 15 W	N/A -





**FURNITURE**

**HEALTH  
AND SAFETY**

## Stainless steel work tables

Stainless steel tables with rounded edges. Hygiene assured and easy to clean.

- Quick assembly without tools
- Height: 900 mm
- Rounded front fascia and backsplash
- Stainless steel tube base, diameter 45 mm
- Feet with adjustment lift and anti-slip tips
- 65 mm recessed feet on backsplash table and 55 mm on center table
- Acoustic comfort, soundproof worktop



Different lengths and other dimensions on request



Stainless steel table without backsplash



Stainless steel table with backsplash

### Central stainless steel tables - depth: 600 mm

Dim.: D x L (mm)	Stainless steel table without backsplash		Stainless steel table with backsplash	
	Cat. No.	Price	Cat. No.	Price
600 x 600	909826	N/A -	909831	N/A -
600 x 1000	909827	N/A -	909832	N/A -
600 x 1200	909828	N/A -	909833	N/A -
600 x 1400	909829	N/A -	909834	N/A -
600 x 1500	909830	N/A -	909835	N/A -

### Central stainless steel tables - depth: 700 mm

Dim.: D x L (mm)	Stainless steel table without backsplash		Stainless steel table with backsplash	
	Cat. No.	Price	Cat. No.	Price
700 x 700	909836	N/A -	909841	N/A -
700 x 1000	909837	N/A -	909842	N/A -
700 x 1200	909838	N/A -	909843	N/A -
700 x 1400	909839	N/A -	909844	N/A -
700 x 1500	909840	N/A -	909845	N/A -

## Laboratory furniture and cabinets

### Mobile furniture

- Furniture with doors and/or drawers
- White water-resistant melamine panels, thickness 19 mm
- 4 swivel wheels, 2 of which have self-locking brakes
- Hinged doors on concealed hinges, 110° opening
- Single door unit with 1 adjustable shelf level
- Delivered assembled, optional locks

#### Furniture with doors

Cat. No.	Dimensions W x D x H (mm) (wheels included)	Composition	Price
922200	500 x 470 x 720	1 door and 1 shelf	N/A -
922201	1000 x 470 x 720	2 doors and 1 shelf	N/A -

#### Lock options

Cat. No.	Description	Price
922209	Lock* / **	N/A -
922238	Fixed price for furniture and lock assembly	N/A -

\* Mandatory Lockmounting  
\*\* For 2-door cabinet: 2 x 922209 and 1 x 922238 per furniture

#### Furniture with drawers

Cat. No.	Dimensions W x D x H (mm) (wheels included)	Composition	Price
922202	500 x 470 x 720	4 drawers	N/A -

#### Lock options

Cat. No.	Description	Price
922209	Lock* / **	N/A -
922238	Fixed price for furniture and lock assembly	N/A -

\* Mandatory Lockmounting  
\*\* For 4-drawer cabinets: 4 x 922209 and 1 x 922238 per furniture

#### Furniture with doors and drawers

Cat. No.	Dimensions W x D x H (mm) (wheels included)	Composition	Price
922203	1000 x 470 x 720	1 door and 4 drawers	N/A -
922204	500 x 470 x 720	1 door, 1 shelf and 1 drawer	N/A -

#### Lock options

Cat. No.	Description	Price
922209	Lock* / **	N/A -
922238	Fixed price for furniture and lock assembly	N/A -

\* Mandatory Lockmounting  
\*\* For furniture with drawers and doors: 1 x 922209 per door and drawer and 1 x 922238 per piece of furniture

#### Under bench cabinet

Cat. No.	Dimensions W x D x H (mm) (wheels included)	Composition	Price
922206	1000 x 470 x 720	1 door and 1 shelf	N/A -
922207	500 x 470 x 720	2 doors and 1 shelf	N/A -



French manufacture

Delivered assembled. Ready to use.

### Hanging furniture

- White water-resistant melamine panels, thickness 19 mm
- With solid swing door(s) or sliding glass door(s)
- Delivered assembled
- Equipped with one shelf for 1-door model, and 2 shelves for 2-door model
- Central divider for 2-door cabinet

Dimensions L x D x H (mm)	Solid doors	Glass doors	Composition	Cat. No.	Price
500 x 350 x 700	Yes	-	1 door and 1 shelf	922210	N/A -
500 x 350 x 700	-	Yes	1 door and 1 shelf	922236	N/A -
1000 x 350 x 700	Yes	-	2 doors and 2 shelves	922211	N/A -
1000 x 350 x 700	-	Yes	2 doors and 2 shelves	922237	N/A -

### High cabinets

- White water-resistant melamine panels, thickness 19 mm
- Hinged doors
- Equipped with 4 shelves for the 1-door model, and 2 x 4 shelves for the 2-door model
- 2-door model with central partition
- Feet with 4 adjustment lifts
- Delivered assembled

Cat. No.	Dimensions L x D x H (mm)	Composition	Price
922213	500 x 600 x 2000	1 hinged door and 4 shelves	N/A -
922214	1000 x 600 x 2000	2 hinged doors and 2 x 4 shelves (central separation)	N/A -

#### Cabinet option

Cat. No.	Description	Price
922216	Additional shelf	N/A -

## Köttermann laboratory furniture



Do you have a new laboratory project?  
Don't waste time...  
Call us!  
We take care of the complete study: 3D plans, estimate, installation...



## Köttermann fixed and mobile work tables

- Different widths and depths
- Melamine TopResist® or Trespa Toplab® Plus coating
- Table with steel shelf
- Total weight supported: 250 kg fixed bench and 100 kg mobile bench
- Delivered disassembled, easy assembly by screwing and gluing

► **TopResist® Melamine**, edge-free, versatile, good chemical resistance, robust, ideal for appliances

► **Laboratory grade HPL, Trespa® TopLab® PLUS**: composed of phenolic resins and cellulose fibres. Very dense, excellent chemical resistance, rot-proof. Easy to decontaminate, ideal for clean room, wet area, and various chemical applications



### Fixed tables 600 mm deep and 900 mm high

Coating	TopResist® Melamine		Trespa Toplab® Plus		
	Dimensions (mm) L x D x H	Cat. No.	Price	Cat. No.	Price
	900 x 600 x 900	382209	N/A -	382228	N/A -
	1200 x 600 x 900	382210	N/A -	382229	N/A -
	1500 x 600 x 900	382211	N/A -	382230	N/A -

### Mobile tables depth 600 mm height 900 mm

Coating	TopResist® Melamine		Trespa Toplab® Plus		
	Dimensions: L x D x H (mm)	Cat. No.	Price	Cat. No.	Price
	1200 x 600 x 900	382215	N/A -	382220	N/A -
	1500 x 600 x 900	382216	N/A -	382221	N/A -

### Fixed tables 750 mm deep and 900 mm high

Coating	TopResist® Melamine		Trespa Toplab® Plus		
	Dimensions (mm) L x D x H	Cat. No.	Price	Cat. No.	Price
	900 x 750 x 900	382212	N/A -	382231	N/A -
	1200 x 750 x 900	382213	N/A -	382232	N/A -
	1500 x 750 x 900	382214	N/A -	382233	N/A -

### Mobile tables depth 750 mm height 900 mm

Coating	TopResist® Melamine		Trespa Toplab® Plus		
	Dimensions: L x D x H (mm)	Cat. No.	Price	Cat. No.	Price
	900 x 750 x 900	382217	N/A -	382222	N/A -
	1200 x 750 x 900	382218	N/A -	382223	N/A -
	1500 x 750 x 900	382219	N/A -	382224	N/A -



## Köttermann under-bench furniture on castors

- Steel construction
- On castors
- Hinged doors, drawers or combined door and drawer openings
- Silent closing
- Furniture with a lock
- Cabinet height 740 mm and depth 516 mm

Description	Width: 450 mm	Width: 600 mm	Width: 900 mm	Width: 1200 mm
1 door and 1 shelf (hinged on the left)	<b>382151</b>	<b>382159</b>	-	-
<b>Price</b>	N/A -	N/A -	-	-
2 doors and 1 shelf	-	-	<b>382205</b>	<b>382143</b>
<b>Price</b>	-	-	N/A -	N/A -
4 drawers (drawers H: 150 mm)	<b>382154</b>	<b>382162</b>	<b>382171</b>	<b>382146</b>
<b>Price</b>	N/A -	N/A -	N/A -	N/A -
2 drawers (drawers H: 300 mm)	<b>382150</b>	<b>382158</b>	<b>382167</b>	<b>382142</b>
<b>Price</b>	N/A -	N/A -	N/A -	N/A -



## Köttermann high cabinets for laboratories

- Electrogalvanised steel construction
- Colour: Arctic white, anthracite base

- External height: 1920 mm
- Various widths: from 600 to 1200 mm



Open cabinet, 3 shelves



2 doors



2 sliding glass doors



2 sliding glass doors,  
2 doors below

### 366 mm deep tall cabinets

Description	Width: 600 mm	Width: 900 mm	Width: 1200 mm
Open cabinet, 3 shelves	<b>382024</b>	<b>382028</b>	<b>382018</b>
<b>Price</b>	N/A -	N/A -	N/A -
2 doors	-	<b>382029</b>	<b>382019</b>
<b>Price</b>	-	N/A -	N/A -
2 sliding glass doors	-	<b>382027</b>	<b>382017</b>
<b>Price</b>	-	N/A -	N/A -
2 sliding glass doors, 2 doors below	-	<b>382036</b>	<b>382034</b>
<b>Price</b>	-	N/A -	N/A -

### 516 mm deep tall cabinets

Description	Width: 600 mm	Width: 900 mm	Width: 1200 mm
Open cabinet, 3 shelves	<b>382025</b>	<b>382031</b>	<b>382021</b>
<b>Price</b>	N/A -	N/A -	N/A -
Cabinet 2 door 3 shelves	-	<b>382033</b>	<b>382023</b>
<b>Price</b>	-	N/A -	N/A -
Cabinet 2 door 4 sliding shelves	-	<b>382032</b>	<b>382022</b>
<b>Price</b>	-	N/A -	N/A -
2 sliding glass doors	-	<b>382030</b>	<b>382020</b>
<b>Price</b>	-	N/A -	N/A -
2 sliding glass doors, 2 doors below	-	<b>382037</b>	<b>382035</b>
<b>Price</b>	-	N/A -	N/A -

## Work furniture-benches to be assembled

Work furniture to be assembled, different colours of legs, panels and edges of shelves.

**Include:**

- worktop with or without sink
- 2 metal legs of 600 mm or 750 mm with or without skirting and shelf (3 metal legs for 1800 mm bench)
- 1 laminate front panel
- 1 back panel
- 1 furniture stop
- 1 fluid cover

**Maximum load: 180 kg**

**Additional mounting possible, please consult us**

**Complies with AFNOR 15201 standards**

**3 possible coatings: enamelled glass, laminate and stoneware**

**Choice of colours:**

- colour of base: white or red
- colour of fascia and edge of shelf: white, yellow or grey to be specified when ordering

1



Bench without skirting and shelf  
600-900-1200-1500 mm

### Bench base 750 mm deep

Coating	Enamelled glass		Laminate		Drawn sandstone		
	Dimensions: L x D (mm)	Cat. No.	Price	Cat. No.	Price	Cat. No.	Price
<b>750 mm worktop and 750 mm deep metal base</b>							
	600 x 750	374124	N/A -	374164	N/A -	374204	N/A -
	900 x 750	374125	N/A -	374165	N/A -	374205	N/A -
	1200 x 750	374126	N/A -	374166	N/A -	374206	N/A -
	1500 x 750	374127	N/A -	374167	N/A -	374207	N/A -
	1800 x 750	374128	N/A -	374168	N/A -	374208	N/A -

### Bench depth 600 mm or 750 mm

Coating	Enamelled glass		Laminate		Drawn sandstone		
	Dimensions: L x D (mm)	Cat. No.	Price	Cat. No.	Price	Cat. No.	Price
<b>600 mm worktop and 600 mm deep metal base</b>							
	600 x 600	374100	N/A -	374140	N/A -	374180	N/A -
	900 x 600	374101	N/A -	374141	N/A -	374181	N/A -
1	1200 x 600	374102	N/A -	374142	N/A -	374182	N/A -
	1500 x 600	374103	N/A -	374143	N/A -	374183	N/A -
2	1800 x 600	374104	N/A -	374144	N/A -	374184	N/A -
<b>750 mm worktop and 600 mm deep metal base</b>							
	600 x 750	374116	N/A -	374156	N/A -	374196	N/A -
	900 x 750	374117	N/A -	374157	N/A -	374197	N/A -
	1200 x 750	374118	N/A -	374158	N/A -	374198	N/A -
	1500 x 750	374119	N/A -	374159	N/A -	374199	N/A -
	1800 x 750	374120	N/A -	374160	N/A -	374200	N/A -

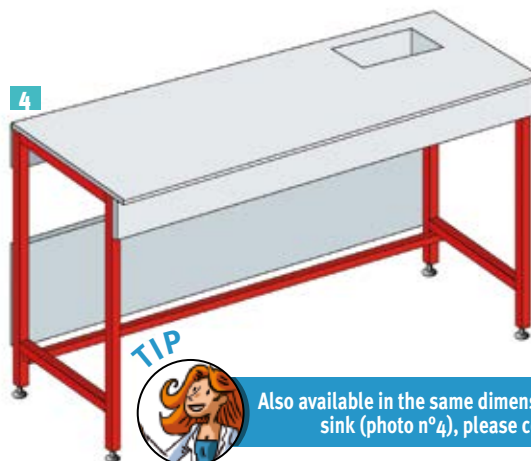

4



Also available in the same dimensions: bench with sink (photo n°4), please consult us.

**Note:**

750 mm deep benches with a 600 mm base cannot be fitted with skirting and shelf. It can only be retrofitted to 750 mm deep benches with 750 mm deep base

750 mm deep benches with a 600 mm base can be placed along the wall even when fluids (e.g. water) are present, thanks to the 150 mm gap between the wall and the base.

### Bench with skirting and shelf, height 90 cm

**Bench with skirting and shelf**

**The melamine backsplash accommodates the tapware and electrical outlets**

### Bench with skirting and shelf, overall depth 750 mm

Coating	Enamelled glass		Laminate		Drawn sandstone		
	Dimensions*: L x D (mm)	Cat. No.	Price	Cat. No.	Price	Cat. No.	Price
<b>600 mm worktop and 600 mm deep metal base</b>							
	600 x 750	374108	N/A -	374148	N/A -	374188	N/A -
	900 x 750	374109	N/A -	374149	N/A -	374189	N/A -
1	1200 x 750	374110	N/A -	374150	N/A -	374190	N/A -
	1500 x 750	374111	N/A -	374151	N/A -	374191	N/A -
	1800 x 750	374112	N/A -	374152	N/A -	374192	N/A -

### Bench with skirting and shelf, overall depth 900 mm

Coating	Enamelled glass		Laminate		Drawn sandstone		
	Dimensions*: L x D (mm)	Cat. No.	Price	Cat. No.	Price	Cat. No.	Price
<b>750 mm worktop and 750 mm deep metal base</b>							
	600 x 900	374132	N/A -	374172	N/A -	374212	N/A -
	900 x 900	374133	N/A -	374173	N/A -	374213	N/A -
	1200 x 900	374134	N/A -	374174	N/A -	374214	N/A -
	1500 x 900	374135	N/A -	374175	N/A -	374215	N/A -
3	1800 x 900	374136	N/A -	374176	N/A -	374216	N/A -

\* the overall depth is equal to the depth of the bench + the skirting and shelf (150 mm)

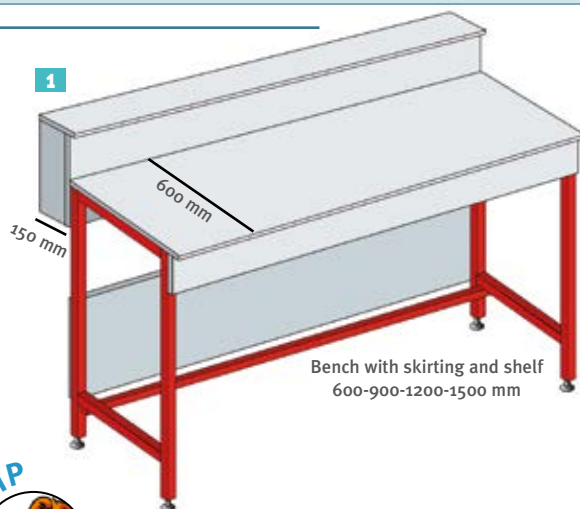

1

Bench with skirting and shelf  
600-900-1200-1500 mm



Bench tops with a skirting and shelf are also available with a washbasin, in the same dimensions. (photo n°4)



4

Bench with skirting and shelf  
with sink 1800 mm

## Workbenches with basins - height 90 cm

### Includes:

- 1 worktop with sink
- 1 sink trap
- 1 fascia strip
- 1 fixed cupboard under the sink or metal leg frame
- With or without skirting and shelf

### Bench with sink on cabinet

Sink composition		Sandstone sink		Polypropylene sink	
Dim.: L x D (mm)	Nbr de sinks	Cat. No.	Price	Cat. No.	Price
600 x 600	1	374276	N/A -	374260	N/A -
900 x 600	1	-	-	374261	N/A -
1200 x 600	2	-	-	374262	N/A -
1500 x 600	2	-	-	374263	N/A -
600 x 750	1	374281	N/A -	374264	N/A -
900 x 750	1	-	-	374265	N/A -
1200 x 750	2	-	-	374266	N/A -
1500 x 750	2	-	-	374267	N/A -

### Bench with sink on cabinet with skirting and shelf

Sink composition		Sandstone sink		Polypropylene sink	
Dim.: L x D (mm)	Nbr de sinks	Cat. No.	Price	Cat. No.	Price
600 x 750	1	374519	N/A -	374268	N/A -
900 x 750	1	-	-	374269	N/A -
1200 x 750	2	-	-	374270	N/A -
1500 x 750	2	-	-	374271	N/A -
600 x 900	1	374524	N/A -	374272	N/A -
900 x 900	1	-	-	374273	N/A -
1200 x 900	2	-	-	374274	N/A -
1500 x 900	2	-	-	374275	N/A -

## Accessories: taps

Gooseneck 250 water taps for tanks and gooseneck 150 for sink.

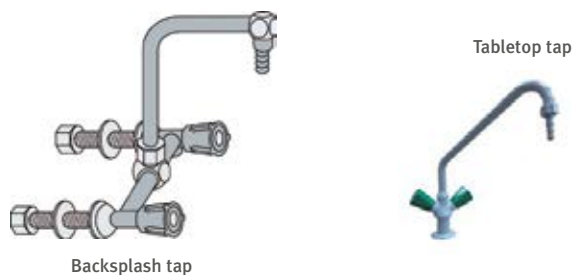

Backsplash tap

Tabletop tap

	Gooseneck at 250		Gooseneck at 150	
	Cat. No.	Price	Cat. No.	Price
Hot and cold water mixer	374306	N/A -	-	-
Cold water tap	374308	N/A -	374307	N/A -

Cat. No.	Description	Price
374316	Flexible water supply elbow on backsplash (2 flexible water supply hoses for the mixer)	N/A -
374318	Flexible discharge	N/A -

	Gooseneck at 250		Gooseneck at 150	
	Cat. No.	Price	Cat. No.	Price
Hot and cold water mixer	374361	N/A -	-	-
Cold water tap	374313	N/A -	374312	N/A -

Cat. No.	Description	Price
374317	Straight supply hose on table (2 hoses are needed for the mixer)	N/A -
374318	Flexible discharge	N/A -

## Weighing table

Cat. No.	Dim.: L x D (mm)	Skirting and shelf	Price
374252	600 x 600	Without	N/A -
374253	600 x 750	With	N/A -
374254	600 x 750	Without	N/A -
374255	600 x 900	With	N/A -

- Laminate worktop with anti-vibration mass
- Height: 900 mm

Weighing table without backsplash



Type of sink	Bench width (mm)	Internal sink dimensions (L x W x D mm)
Drawn sandstone slabs	600	1 sink: 450 x 390 x 210
	600	1 sink: 380 x 380 x 210
Made of polypropylene	900	1 sink: 540 x 380 x 310
	1200 y 1500	2 sink: 380 x 380 x 210

Bench with sink, on cabinet

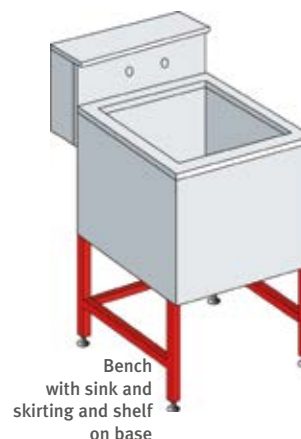
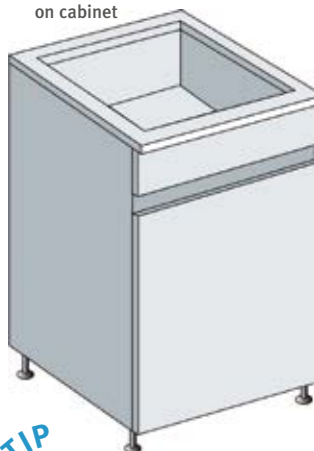

Bench with sink and skirting and shelf on base

TIP



Also available: bench with sink and/or skirting and shelf, consult us.

## Other sinks on request

## Angles for benches

### Includes:

- 1 worktop
- 1 corner base with or without skirting and shelf (skirting and shelf depth 150 mm)

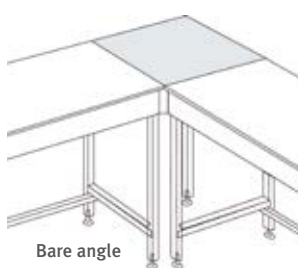

Bare angle

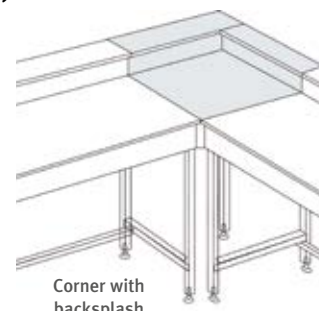

Corner with backsplash

### Bare angle

Coating	Enamelled glass		Laminate		Drawn sandstone	
	Cat. No.	Price	Cat. No.	Price	Cat. No.	Price
Dimensions: L x D (mm)						
600 x 600	374220	N/A -	374224	N/A -	374228	N/A -
750 x 750	374222	N/A -	374226	N/A -	374230	N/A -

### Corner with skirting and shelf

Coating	Enamelled glass		Laminate		Drawn sandstone	
	Cat. No.	Price	Cat. No.	Price	Cat. No.	Price
Dimensions: L x D (mm)						
750 x 750	374221	N/A -	374225	N/A -	374229	N/A -
900 x 900	374223	N/A -	374227	N/A -	374231	N/A -

## Central technical chamber

➤ Can be placed between 2 benches

➤ To be mounted

➤ Includes:

- melamine pedestal
- laminated brackets
- compact resin shelf

## Bare technical central housing

Dimensions (mm)	600 x 300	900 x 300	1200 x 300	1500 x 300	1800 x 300
Cat. No.	374232	374233	374234	374235	374236
Price	N/A -	N/A -	N/A -	N/A -	N/A -

## Technical central housing with small sink

Dimensions (mm)	1200 x 300	1500 x 300	1800 x 300
Cat. No.	374237	374238	374239
Price	N/A -	N/A -	N/A -

## Accessories: electrical outlets for backsplash or technical chamber

Cat. No.	Description	Price
374319	Block of 3 wired sockets (2 P + T)	N/A -
374320	Block of 4 wired sockets (2 P + T)	N/A -

## Furniture on castors

### Furniture with doors

Cat. No.	Dim.: L x H x D (mm)	Composition	Price
374323	535 x 720 x 450	1 door - 1 shelf	N/A -
374328	835 x 720 x 450	2 doors - 1 shelf	N/A -
374334	1135 x 720 x 450	2 doors - 1 shelf	N/A -

### 3-drawer furniture

Cat. No.	Dim.: L x H x D (mm)	Price
374383	535 x 720 x 450	N/A -
374384	835 x 720 x 450	N/A -

Door cabinet with drawers 374325

Door cabinet with drawers 374330



### Door cabinet with drawers

Cat. No.	Dim.: L x H x D (mm)	Composition	Price
374330	835 x 720 x 450	2 doors +1 drawer - 1 shelf	N/A -
374325	535 x 720 x 450	1 door +1 drawer - 1 shelf	N/A -

## Accessories: locks

Cat. No.	Description	Price
374438	Lock for mobile cabinet 1 or 2 doors	N/A -
374439	Lock for mobile cabinet on top drawer	N/A -
374440	Central lock for mobile drawer cabinet	N/A -

## Built-in cabinet with sliding doors

Dimension: L (mm)	For 600 mm deep base		For 750 mm deep base	
	Cat. No.	Price	Cat. No.	Price
1200	374335	N/A -	374338	N/A -
1500	374336	N/A -	374339	N/A -
1800	374337	N/A -	374340	N/A -

### Half-cabinet only for bench 1800

855	374341	N/A -	374342	N/A -
-----	--------	-------	--------	-------

➤ Delivered in kit, must be mounted under a bench

➤ Recessed underneath bench frames

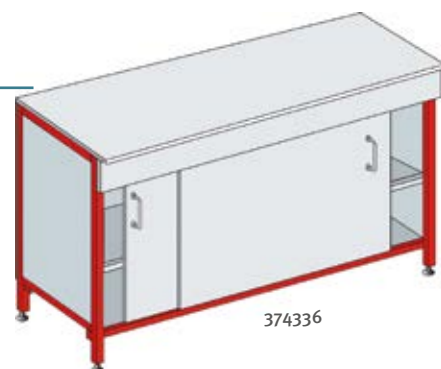

## Storage

### Wall cupboards

- Solid or glass doors
- White melamine
- 1 adjustable table
- Delivered assembled
- L x D x H (mm) 900 x 370 x 800

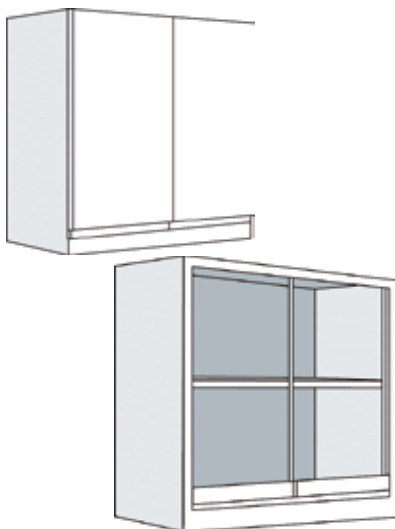

Cat. No.	Description	Price
374343	Cupboard with solid doors	N/A -
374346	Cupboard with glass doors	N/A -

### Tall cabinet

- White melamine, 165° opening
- 3 shelves, 2 of which are height adjustable
- 1 lock and 2 metal handles
- Delivered in kit form: to be assembled

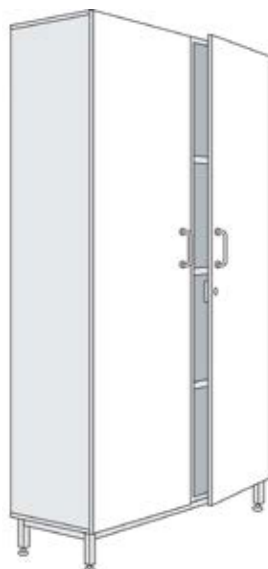

Cat. No.	L x D x H (mm)	Price
374345	1200 x 416 x 2000	N/A -

### Display cabinet

- Top with 2 glass sliding doors, 2 shelves on adjustable pins
- Bottom with 2 solid doors with 1 shelf on adjustable pins
- Delivered assembled in 2 parts (to be re-assembled)

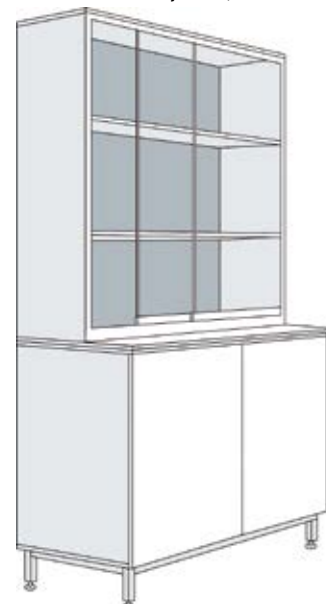

Cat. No.	L x H (mm)	P top (mm)	P bottom (mm)	Price
374348	1200 x 2000	350	600	N/A -



## Adjustable footrest

- **Massaging bumpy surface**
- **Fixed platform**
- **2 position adjustable tilt**
- **Dimensions L x D (cm): 44.8 x 33**



Cat. No.	Description	Price
959002	Adjustable footrest	N/A -

## Stool

- **Injected polypropylene**
- **Dimensions: 360 x 360 x 460 mm**

Cat. No.	Description	Price
039665B	Stool	N/A -



## Stainless steel stool

- **Stainless steel construction**
- **Special sterile rooms**
- **Continuous welds**
- **Welded tube ends**
- **Smooth stainless steel seat on all sides**
- **No retention area**
- **Height 700 mm**
- **30 x 30 cm square tube or round tube construction**
- **Seat size: 300 x 300 mm**



Cat. No.	Description	Price
451002	Aseptic stool	N/A -

## Aseptic stainless steel stools

- **Specially designed for cleanrooms**
- **The branches are made of stainless steel plate and not of tube, so there are no retention zones**
- **Suitable for jet washing**
- **Height adjustment with stainless steel screws from 490 to 790 mm**
- **Base ø 530 mm**
- **Stainless steel legs and seat support**
- **Perfect stability thanks to 5 feet on stainless steel adjustment lifts**
- **Durability and robustness**

### Options

- **Footrest:** provides a more comfortable working posture when the seat is in the upright position
- **Castors**

Cat. No.	Description	Price
451000	Stainless steel standing seat stool Tabat	N/A -
451001	Stainless steel seat Siat	N/A -
451003	Footrest	N/A -
451004	Casters kit	N/A -



## Height adjustable stool

- **Round seat in black polyurethane foam**
- **Height adjustment by means of a chrome-plated telescopic column with gas-lift lock and seat cushion**

Cat. No.	Model	Footrest peds	Height (mm)	Price
216007	Top	With	540 to 780	N/A -
216022	Top	Without	540 to 780	N/A -
216012	Intermediate	With	470 to 600	N/A -
216027	Intermediate	Without	470 to 600	N/A -
216036	Bottom	Without	400 to 530	N/A -



## Standing seat



- **Ergonomic design eliminates body weight fatigue in the standing position**
- **Very stable and with a small footprint, it leaves the user free to move**
- **Bottom dimensions bas (L x W): 490 x 330 mm**
- **Height adjustment by means of a lift-gas column with seat damper, tilted and rotationally fixed or by means of a stainless steel mechanical column**



Model	Black	Blue	Grey	Price
Standard	216121	216123	216124	N/A -
Stainless steel	216117	216119	-	N/A -



## Kor Seats

Delivered in **BLACK**, other colours available on request, please consult us:

-  Anthracite grey (= Mundial Macadam)
-  Navy blue (= Mundial Saphir)
-  Blue jeans (= Mundial Blue Jean)

-  Red (Mundial Cerise)
-  Orange (= Mundial Poterie)

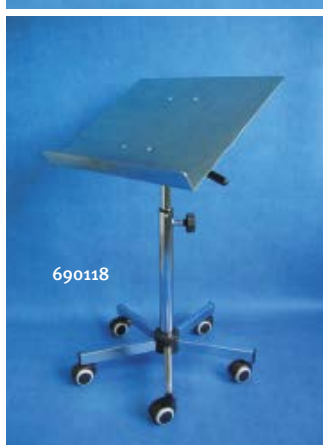

### Vinyl seats with gas lift

- ▶ Seat with protective cover
- ▶ Tilting steel backrest, adjustable height and depth
- ▶ Adjustments by gas lift
- ▶ Supplied in black (other colours available on request)

Cat. No.	Description	Seat (cm)	Height (cm)	Footrest	Price
690103	Seat on wheels	41 x 40	55 - 80	T shape	N/A -
690104	Seat with 5 glides	41 x 40	55 - 80	T shape	N/A -
690105	Seat on wheels	41 x 40	55 - 80	In a circle	N/A -
690106	Seat with 5 glides	41 x 40	55 - 80	In a circle	N/A -
690107	Seat on wheels	45 x 43	55 - 80	In a circle	N/A -
690108	Seat with 5 glides	45 x 43	55 - 80	In a circle	N/A -

### Polyurethane seats with gas lift

- ▶ Height and depth adjustable wire backrest
- ▶ Height adjustable footrest circle
- ▶ Chrome-plated steel base on polyurethane castors
- ▶ Supplied in black

Cat. No.	Description	Seat (cm)	Height (cm)	Footrest	Price
690113	Seat on wheels	46 x 42	55 - 80	In a circle	N/A -
690114	Seat with 5 glides	46 x 42	55 - 80	In a circle	N/A -

### Vinyl stools with gas lift

- ▶ Round cushioned seat Ø 33 cm
- ▶ Supplied in black (other colours available on request)

Cat. No.	Description	Height (cm)	Footrest	Price
690109	Stool with 5 castors	55 - 80	In a circle	N/A -
690110	Stool with 5 glides	55 - 80	In a circle	N/A -
690111	Stool with 5 castors	55 - 80	T shape	N/A -
690112	Stool with 5 glides	55 - 80	T shape	N/A -

### Vinyl gas lift standing seat

- ▶ 5-star base in black reinforced polyamide Ø 560 mm
- ▶ 5 extra wide conical glides
- ▶ Ergonomic saddle seat

Cat. No.	Description	Seat (cm)	Height (cm)	Price
690115	Stand-up seat	38 x 26	53 - 79	N/A -
690116	Stand-up seat	32 x 30	56 - 82	N/A -

### Rolling table

- ▶ Variable height table
- ▶ 670 x 470 mm melamine tray
- ▶ Impact resistant edges and rounded corners

Cat. No.	Description	Dimensions tray (mm)	Price
690117	Rolling table	670 x 470	N/A -

### Serving trolley

- ▶ Tilting tray
- ▶ Tray 550 x 400 mm
- ▶ Variable tilt, free or closed swivel
- ▶ Chromium-plated steel base on Ø 50 mm castors
- ▶ Supported load: 40 k

Cat. No.	Description	Dimensions tray (mm)	Price
690118	Trolley with tilting tray	500 x 400	N/A -

## Eco polyurethane seats

- Integral polyurethane foam
- Polyamide base
- Permanent contact mechanism
- Height adjustable seat
- Seat dimensions 400 x 395 mm
- Backrest dimensions: 350 x 200 mm
- Complies with EN 1021 1-2

Cat. No.	Backrest	Base	Footrest	Height (mm)	Price
216427	Permanent contact	Castors	No	480 - 610	N/A -



## Koncept Seats

- Ergonomic, reduces fatigue
- Versatile
- Ecological
- 5-star steel base with hinged glides or castors
- Gas lift column for adjustable seat height
- Seat cushioning
- One-piece aluminium footrest, height adjustable with all-round clamping
- Deformable seat made of soft black polyurethane foam, tilted by 2° towards the front
- Mounting on elastomer pads: self-adapting system to the user's movements
- With or without lumbar support made of soft black polyurethane foam, depth adjustable
- Warranty: 5 years



Seat height (mm)	Type of feet	Without lumbar support		With lumbar support	
		Cat. No.	Price	Cat. No.	Price
470 to 605	Glides	216327	N/A -	216334	N/A -
510 to 645	Castors locked under load	216328	N/A -	216335	N/A -
510 to 645	Standard castors	216329	N/A -	216336	N/A -
510 to 645	Castors with soft wheels	216330	N/A -	216337	N/A -
510 to 645	Castors with brakes	216331	N/A -	216338	N/A -
610 to 855	High with glides	216332	N/A -	216339	N/A -
610 to 855	High with glides and footrest	216333	N/A -	216340	N/A -
660 to 765	Foot-operated glides	216341	N/A -	-	-
660 to 765	Load-locking castors with foot control	216342	N/A -	-	-
660 to 765	Soft wheels castors with foot control	216343	N/A -	-	-

## Semi seated

- Ergonomically designed seat with a forward slope, made of soft polyurethane foam for optimum comfort (minimum thickness 4 cm)
- No warming up or sweating effect
- Height adjustment by lift-gas column: 550 to 790 mm
- Very robust: Kango's patented flexible polyurethane is resistant to cutting tools, sparks, light acids and hydrocarbons
- Washable with standard cleaning products
- Also available in stainless steel, with polyurethane or polyolefin coating (consult us)

Model	Footrest	Legs	Black	Blue	Price
High	Yes	Short	216044B	216050B	N/A -
High	Yes	Long	216045B	216051B	N/A -
High	No	Short	216056B	216062B	N/A -
High	No	Long	216057B	216063B	N/A -
Intermediate	Yes	Short	216067B	216071B	N/A -
Intermediate	Yes	Long	216068B	216072B	N/A -
Intermediate	No	Short	216075B	-	N/A -
Intermediate	No	Long	216076B	-	N/A -
Low	No	Short	216080B	216094B	N/A -
Low	No	Long	216081B	216095B	N/A -
Low casters standard	No	Long	216082B	216096B	N/A -
Low casters with brakes	No	Long	216083B	216097B	N/A -
Low casters locked	Non	Long	216084B	216098B	N/A -
Low casters without brakes	No	Long	216085B	-	N/A -





## ALSIT laboratory chairs and stools

### POLYURETHANE RANGE

- **Coating:**
  - black
  - polyurethane (PU) coating, compact foam injected around a supporting structure
  - resistant to impacts, cuts, sparks and common solvents
- **Lift:** gas spring, chrome-plated steel tube with shock absorber tested to DIN 4550, adjustable height
- **Base:** chromed steel on glides or castors, diameter 54 cm



- Stools**
- **Seat:** Ø 33 cm, thickness 5 cm
  - **Black PU**

Cat. No.	Base	Footrest	Seat height (cm)	Price
694068	5 glides	No	48 - 68	N/A -
694268	5 glides	Yes	48 - 68	N/A -
694069	5 castors	No	50 - 70	N/A -
694269	5 castors	Yes	50 - 70	N/A -

#### Technical seats

- **Seat:** W x D (cm) = 46 x 42, curved, with anti-slip relief
- **Backrest:** H (cm) = 30, adjustable, grip and rotating seat.
- **Footrest -** height adjustable chrome steel ring, Ø = 44 cm

Cat. No.	Description	Base	Seat height (cm)	Price
694000	Technical seat, black PU	5 castors*	55 - 80	N/A -
694070	Technical seat, black PU	5 glides	53 - 78	N/A -

\* Ø 5 cm double-roll castors designed for hard floors

### BOEING RANGE - PVC COATED FABRIC

- **Coating:**
  - washable, made of Boeing foam (PVC-coated fabric)
  - M1 fire classification according to DIN4102B2 and EN1021-1-2
  - high density padding, high resilience foam: optimal comfort in prolonged use

- **Lift:** gas spring, chrome-plated steel tube with shock absorber tested to DIN 4550, adjustable height
- **Base:** chrome-plated steel Ø 54 cm, on glides or castors Ø 5 cm
- **Circular footrest** in chromed steel with a diameter of 44 cm



694154

694157

694201

694167

694234

694260

694177

Features	Stools				Technical Seats				Technical Seats Wide seat and reclining backrest			
	► <b>Seat:</b> Ø 33 cm, thickness 4.5 cm		► <b>Easy to clean:</b> stool bottoms covered with a waterproof vinyl sheet		► <b>Seat:</b> width 44 cm, depth 40 cm		► <b>Backrest:</b> height 25 cm, adjustable height, rotating seat.		► <b>Seat:</b> width 47 cm, depth 44 cm		► <b>Backrest:</b> height 33 cm, adjustable height, permanent contact (backrest tilt adjustable)	
Base	5 glides		5 castors		5 glides		5 castors		5 glides		5 castors	
Seat height (cm)	53 - 78		55 - 80		53 - 79		56 - 81		55 - 80		57 - 82	
Footrest	No	Yes	No	Yes	No	Yes	No	Yes	No	Yes	No	Yes
Colours												
Tangerine	694046	694195	694152	694209	694038	694221	694164	694232	694078	694244	694176	694256
Pebble	694047	694196	694153	694210	694005	694270	694165	694233	694079	694245	694177	694257
Turquoise	694048	694197	694154	694211	694039	694222	694166	694234	694080	694246	694178	694258
Pumpkin	694049	694198	694155	694212	694040	694223	694167	694235	694081	694247	694179	694259
Cobalt	694050	694199	694156	694213	694002	694224	694168	694236	694082	694248	694180	694260
Aegean Blue	694051	694200	694157	694214	694041	694225	694169	694237	694083	694249	694181	694261
Pollen	694052	694201	694158	694215	694042	694226	694170	694238	694084	694250	694182	694262
Anthracite	694053	694202	694159	694216	694001	694227	694171	694239	694085	694251	694183	694263
Black	694054	694203	694160	694217	694006	694228	694172	694240	694086	694252	694184	694264
Red	694055	694204	694161	694218	694007	694229	694173	694241	694087	694253	694185	694265
Glycine	694056	694206	694162	694219	694004	694230	694174	694242	694088	694254	694186	694266
Fuschia	694057	694207	694163	694220	694003	694231	694175	694243	694089	694255	694187	694267
Price	N/A -	N/A -	N/A -	N/A -	N/A -	N/A -	N/A -	N/A -	N/A -	N/A -	N/A -	N/A -

\* Hard floor castors, braked off-load and braked on-load available, consult us.



## ALSIT laboratory chairs and stools (continued)

### ANTISTATIC RANGE

**Stools:** ▶ Seat: Ø 33 cm, thickness 5 cm

Base	Seat height (cm)	Without footrest		With footrest	
		Cat. No.	Price	Cat. No.	Price
5 glides	40 - 53	694290	N/A -	694313	N/A -
5 glides	47 - 67	694291	N/A -	694314	N/A -
5 glides	53 - 78	694292	N/A -	694315	N/A -
5 glides	62 - 87	694293	N/A -	694316	N/A -
5 castors	42 - 55	694294	N/A -	694317	N/A -
5 castors	49 - 69	694295	N/A -	694318	N/A -
5 castors	55 - 80	694296	N/A -	694319	N/A -

- ▶ Models designed according to the recommendations of the NF74010 standard
- ▶ Black vinyl coating
- ▶ Lift: gas spring, chrome-plated steel tube with shock absorber tested to DIN 4550, adjustable height
- ▶ Chromium-plated steel base on glides or castors, diameter 54 cm



**Standing seat:** ▶ Seat L x D: 34 x 27 cm

Base	Seat height (cm)	Cat. No.	Price
5 glides	53 - 78	694297	N/A -
5 glides	62 - 87	694298	N/A -

#### Technical seat

- ▶ Seat: width 44 cm, depth 39 cm
- ▶ Backrest: height 25 cm, adjustable in height

#### Technical seat with permanent contact

- ▶ Seat: width 47 cm, depth 44 cm
- ▶ Backrest: height 33 cm, adjustable in height, adjustable inclination

Base	Seat height (cm)	Without footrest		With footrest		Without footrest		With footrest	
		Cat. No.	Price	Cat. No.	Price	Cat. No.	Price	Cat. No.	Price
5 glides	41 - 54	694299	N/A -	694320	N/A -	694306	N/A -	694325	N/A -
5 glides	48 - 68	694300	N/A -	694321	N/A -	694307	N/A -	694326	N/A -
5 glides	54 - 79	694301	N/A -	694323	N/A -	694308	N/A -	694066	N/A -
5 glides	63 - 88	694302	N/A -	694322	N/A -	694309	N/A -	694327	N/A -
5 castors	43 - 56	694303	N/A -	694323	N/A -	694310	N/A -	694328	N/A -
5 castors	50 - 70	694304	N/A -	694324	N/A -	694311	N/A -	694329	N/A -
5 castors	56 - 81	694305	N/A -	694065	N/A -	694312	N/A -	694330	N/A -

### Standing seat FIN BIMOS

- ▶ Wide seat mounted on an ergonomic tilt column
- ▶ Supports 60% of body weight
- ▶ Smaller footprint
- ▶ Intuitive operation and easy adjustment; 20° swivel seat
- ▶ Adjustable Height: 660 to 850 mm
- ▶ Stable, light and mobile
- ▶ Large integrated handles
- ▶ Robust aluminium base
- ▶ PU foam seat

Cat. No.	Description	Price
724731	FIN standing seat - PU foam seat - black	N/A -
724732	FIN standing seat - PU foam seat - blue	N/A -
724733	FIN standing seat - PU foam seat - grey	N/A -
724734	Standing seat FIN ESD - PU foam seat - grey	N/A -



## BIMOS technical seats



### "Laboratory Basic" seats

- Wide, padded and curved seat and backrest for comfort and ergonomics
- Seat height adjustment: 620 - 870 mm
- Seat height adjustment
- Seat tilt adjustment (specific model)
- Choice of 2 coatings:
- 5-star hard steel base
- Black synthetic leather or black Duotec fabric (other colours on request)
- With castors or glides
- Delivered in kit, easy to assemble
- Other models, please contact us

#### Duotec fabric:

- Made of 95% polyacryl and 5% Lycra; tear-resistant and breathable.

#### Faux Leather:

- Superior abrasion resistance, washable and resistant to disinfectants.

Model	BASIC 1 laboratory seats on glides		BASIC 2 laboratory chairs on castors	
Base in black	Yes		Yes	
Standard steel base	Yes		Yes	
Permanent contact backrest	Yes		Yes	
Seat tilt adjustment	No	Yes	No	Yes
Backrest height adjustment	Yes		Yes	
Seat height (mm)	470 - 610		470 - 610	
Backrest height (mm)	430	530	430	530
Seat and backrest coated in black Duotec fabric	724505	724507	724509	724511
Price	N/A -	N/A -	N/A -	N/A -
Seat and backrest coated Black Faux Leather	724506	724508	724510	724512
Price	N/A -	N/A -	N/A -	N/A -

### "Nexxit" seats

- High comfort and extreme resistance.

- High quality industrial ergonomics, intuitive and simple settings
- Suitable for prolonged standing at the workplace: seat and backrest with thick, soft padding for good blood circulation and rounded edges
- Extreme mobility, easy handling thanks to handles
- Multiple adjustments: seat depth, seat tilt and back height
- Backrest: functional handles for moving around, wide freedom of movement thanks to the narrow top. Synchronous system with automatic tension adjustment
- Epoxy painted steel base, very stable (aluminium base available as an option)
- Delivered in kit (seats mounted under optional cover, please consult us)
- Choice of coatings:
  - Faux leather: washable, easy care, resistant to disinfectants. Antibacterial effect. PVC and phthalate free; flame retardant (EN 1021-1, 2);
  - integral foam (PU): robust and easy to maintain. Washable, resistant to disinfectants. PVC-free; flame retardant (EN 1021-1, 2).



Other coatings available on our website, the range is also available in ESD version, please consult us.



Nexxit 1 seat, PU integral foam, green handles



Model	Nexxit seat 1		Nexxit seat 2		Nexxit seat 3	
	➤ With glides		➤ With soft castors for hard floors (with brakes)		➤ With glides	
Seat height (mm)	-		450 - 600		570 - 820	
Seat width (mm)			460			
Backrest height (mm)			530			
Backrest adjustment height (mm)			70			
Seat depth adjustment (mm)			50			
seat tilt adjustment (°)			4			
Coating	Faux leather	PU foam	Faux leather	PU foam	Faux leather	PU foam
	Cat. No.	Cat. No.	Cat. No.	Cat. No.	Cat. No.	Cat. No.
Blue handles	724602	724607	724622	724627	724642	724647
Anthracite handles	724603	724608	724623	724628	724643	724648
Orange handles	724604	724609	724624	724629	724644	724649
Green handles	724605	724610	724625	724630	724645	724650
Without handles	724606	724611	724626	724631	724646	724651
Price	N/A -	N/A -	N/A -	N/A -	N/A -	N/A -

### Options

Cat. No.	Description	Price
724657	Armrests for Nexxit seat (set of 2): adjustable in height, width, depth and orientation	N/A -
724583	Circular footrest for Nexxit 1 and 2	N/A -
724588	Roulettes blocantes (blocked under load) for Nexxit 3	N/A -

## BIMOS technical seats (continued)

### "Neon" seats

- A permanent contact mechanical structure or synchronous system
- 2 removable, interchangeable cushions
- Cushion coating to be chosen according to use (other coatings, please consult us)
- Cushion colour: standard black with orange border (other colours on request)
- Ergonomic and comfortable shape, wide at the bottom and narrow at the top
- Permanent contact backrest or synchronous system
- Individual backrest height and seat depth adjustment for perfect back support
- Delivered in kit, easy to assemble
- Other models, please contact us



#### Choice of 2 coatings:

Neon Faux leather filling:

- Washable, easy to clean, resistant to oils and disinfectants, soft and comfortable, very robust.

Neon integral foam padding:

- extremely robust, washable, resistant to mechanical stress, spark-proof, not sensitive to light acids and easy to clean;
- recommended in environments where aggressive substances are handled.

Model	Neon 1 seats on glides		Neon 2 seats on castors	
				
Black aluminium base	Yes		Yes	
Permanent contact backrest	Yes	No	Yes	No
Synchronous system	No	Yes	No	Yes
Tension adjustment	Yes		Yes	
Seat depth adjustment	Yes		Yes	
Seat tilt adjustment	Yes		Yes	
Backrest height adjustment	Yes		Yes	
Standard edge / Happy orange	Standard		Standard	
<b>Faux leather coating cushion, Magic black</b>	<b>724513</b>	<b>724515</b>	<b>724517</b>	<b>724519</b>
<b>Price</b>	<b>N/A -</b>	<b>N/A -</b>	<b>N/A -</b>	<b>N/A -</b>
<b>Black integral foam cushion</b>	<b>724514</b>	<b>724516</b>	<b>724518</b>	<b>724520</b>
<b>Price</b>	<b>N/A -</b>	<b>N/A -</b>	<b>N/A -</b>	<b>N/A -</b>

### "Labsit" seats

- Seats suitable for many laboratories
- Ergonomic and flexible, easily adaptable to the user's movements
- 2 types of coatings: Faux leather or polyurethane foam, easy to maintain and clean, anti-bacterial treatment
- Polyamide base (aluminium base available as an option)
- Modern design with a choice of colours

724521



Model	Labsit 2 seat		Labsit 3 seat		Labsit 4 seat	
	➤ On castors and base		➤ On glides with footrest		➤ Self-locking castors and circular footrest	
Seat height (mm)	450 - 650		520 - 770		560 - 810	
Seat width (mm)	450		450		450	
Seat depth (mm)	420		420		420	
<b>Faux leather model</b>	<b>Cat. No.</b>	<b>Price</b>	<b>Cat. No.</b>	<b>Price</b>	<b>Cat. No.</b>	<b>Price</b>
Blue	724521	N/A -	724525	N/A -	724529	N/A -
Anthracite	724533	N/A -	724537	N/A -	724541	N/A -
White	724545	N/A -	724549	N/A -	724553	N/A -
Orange	724557	N/A -	724561	N/A -	724565	N/A -
Green	724569	N/A -	724574	N/A -	724577	N/A -
<b>PU foam model</b>	<b>Cat. No.</b>	<b>Price</b>	<b>Cat. No.</b>	<b>Price</b>	<b>Cat. No.</b>	<b>Price</b>
Blue	724522	N/A -	724526	N/A -	724530	N/A -
Anthracite	724534	N/A -	724538	N/A -	724542	N/A -
White	724546	N/A -	724550	N/A -	724554	N/A -
Orange	724558	N/A -	724562	N/A -	724566	N/A -
Green	724570	N/A -	724574	N/A -	724578	N/A -

### "Labsit" Stool

- Stool on castors with comfortable seat
- Washable, disinfectant resistant and robust
- Seat height 450 - 650 mm
- Seat width and depth: 400 mm
- Base diameter: 640 mm
- Polyurethane foam seat and polyamide base



### Optional: armrests

Cat. No.	Description	Price
724581	Armrests for seat (set of 2)	N/A -

Cat. No.	Description	Price
724582	Labsit PU stool black with castors	N/A -



